



Latitude[®] by Genesys

Printable Help for Users

Version 2020 R2

Last updated October 13, 2020

Abstract

This document is a printable version of Latitude by Genesys help for users.

For copyright and trademark information, see

[https://help.genesys.com/latitude/Liquid/Desktop/Copyright and Trademark Information.htm](https://help.genesys.com/latitude/Liquid/Desktop/Copyright%20and%20Trademark%20Information.htm).

Table of Contents

Introduction to Latitude.....	1
What's New in Latitude.....	2
2020 R1	2
Permissions	2
Genesys Cloud integration.....	2
Reference panels.....	2
System codes and settings.....	2
Task panels.....	3
2020 R2	3
Account Analysis	3
Permissions	3
Task panels.....	3
Log On to Latitude.....	4
Change Your Password.....	6
Work Form Overview.....	7
Help Overview.....	10
Search feature.....	11
Search syntax	11
Wildcard expressions.....	11
Boolean operators	12
Nested expressions	12
Screen captures.....	12
Account Retrieval.....	13
Account Retrieval.....	13
Search.....	13
Account Search	13
Search for an Account.....	13
Select an Account From Search Results.....	16
Locate an Account Using Quick Search.....	17
Quick Search Codes.....	18

Open Interactions	18
Open Interactions	18
View Open Interactions	19
Select an Account From Open Interactions	20
Close an Open Interaction	20
Work Queues	21
Work Queues	21
Open the Collector Queue	22
Open the Custom Queue	23
Open the Clerical Queue	25
Open the Supervisor Queue.....	26
Open the Pool Queue.....	27
Close a Work Queue	28
History.....	29
Account History.....	29
Select an Account From History.....	29
Purge Account History	30
Select an Account from Inventory	30
Latitude Integration with PureConnect	32
PureConnect Dialer Agent Interface	32
Log on to PureConnect Dialer Agent Interface	33
Set Your Workgroup Status (PureConnect)	36
Interaction Dialer Campaigns.....	37
Interaction Dialer Campaigns.....	37
PureConnect Dialer Agent Interface Icons.....	37
Log on to a Campaign (PureConnect)	38
Work a Power or Predictive Campaign (PureConnect).....	40
Work a Preview Campaign (PureConnect).....	41
Disposition a Call (PureConnect).....	42
Request a Break (PureConnect)	43
End Your Break (PureConnect)	43
Request Assistance with a Call (PureConnect).....	44

Latitude Printable Help

- Transfer a Call (PureConnect) 45
- View Your Campaign Interactions (PureConnect) 45
- Log off a Campaign (PureConnect) 46
- Dialer User Statuses (PureConnect)..... 47
 - Dialer User Statuses (PureConnect)..... 47
 - Change Your Dialer Status (PureConnect) 47
 - Add a Note About Your Dialer Status (PureConnect) 49
 - Modify or Remove a Dialer Status Note (PureConnect) 51
 - View User Directory (PureConnect)..... 52
- Dialer Views (PureConnect) 53
 - Dialer Views (PureConnect) 53
 - View a Workgroup Queue (PureConnect) 54
 - View Your Interactions (PureConnect) 54
- View Your Call History (PureConnect) 55
- Place an Outbound Call (PureConnect)..... 56
- Change Your Station (PureConnect) 57
- Change Your Dialer Password (PureConnect)..... 58
- Log off PureConnect Dialer Agent Interface 59
- Latitude Integration with Genesys Cloud 61
 - Latitude Integration with Genesys Cloud 61
 - Integration features 61
 - Latitude configuration..... 61
 - Other configurations 62
 - Genesys Cloud Client 62
 - Log on to Genesys Cloud Client 67
 - Campaign Call Process 69
 - Power or Predictive campaign 69
 - Preview campaign 70
 - Log off Genesys Cloud Client 70
- Validate a Call..... 72
- View Account Warnings 75
- Display a Web Site on a New Browser Tab 77

Delinquency or Recovery Anchor..... 78

 Delinquency or Recovery Anchor..... 78

Account Labels Card..... 78

 Account Labels Card..... 78

 Create a Label 79

 Add a Label to an Account 79

 View Labels Associated to an Account..... 80

 Delete a Label From an Account 80

Account Navigator Card 81

Account State Card 81

Account Status Card..... 82

Account Summary Card 82

AIM Card 83

Charge-off Details Card..... 84

Contact Card 84

Delinquency Card..... 85

First Party Active Collections Card..... 85

Hot Notes Card..... 86

 Hot Notes Card..... 86

 Add a Hot Note to an Account..... 87

 Add a Standard Note to an Account 87

Joined Accounts 88

 Joined Accounts Overview 88

 Joined Accounts Card..... 89

 Medical Account Details Card 91

Link Summary Card 92

Party Card..... 93

Party Navigator Card..... 93

Pending Payments Card 94

Support Queue Details Card 95

Account Detail..... 96

 Account Detail..... 96

Latitude Printable Help

View Account Balance Details.....	96
Current Balance.....	96
History Balance	97
View or Modify Account Dates	97
View Additional Account Information	98
View Contact Analysis Information.....	99
View Client Guidelines	100
View Information for Linked Accounts	100
First-party active collections	101
First-party recovery or third-party collections.....	101
Account Links	103
Account Links	103
Data merge.....	103
Add a Link to an Account	103
Remove all Links to an Account	104
Account Reminders.....	106
Account Reminders.....	106
Set a Timed Reminder.....	106
View Timed Reminders	108
Reschedule or Dismiss a Timed Reminder	108
Set an Account Follow-up Date.....	109
Statuses.....	112
Statuses.....	112
Select a Quick-pick Account Status	112
Change an Account Status	112
Select Accounts	113
Maintain the Quick-pick Account Status List	114
Standard Status Codes	115
Processes and Stages	118
Processes and Stages	118
Start an Account in a Process.....	118
Move an Account to the Next Process Stage.....	118

Move an Account to the Previous Process Stage.....	119
View the Available Processes and Stages for an Account.....	119
Placements and Recalls.....	121
Placements and Recalls.....	121
Place an Account With an Agency or Attorney.....	121
Recall an Account From an Agency or Attorney.....	123
Manage Interest.....	124
Collection Holds.....	125
Collection Holds.....	125
Account-level hold.....	125
Customer-level hold.....	125
Place an Account-Level Hold.....	125
Place a Customer-Level Hold.....	126
Remove an Account-Level Hold.....	126
Remove a Customer-Level Hold.....	127
Task Panels.....	128
Task Panels.....	128
Customers.....	128
Customers.....	128
Contact Information.....	128
Maintain Employer Information.....	138
Maintain Spouse Information.....	139
Maintain Attorney Information.....	140
Bankruptcy.....	140
Maintain Deceased Information.....	144
Maintain Assets.....	145
Maintain CCCS Information.....	146
Customer Icons.....	147
Arrangements.....	147
Arrangements.....	147
Propose a Payment Arrangement.....	148
Modify a Payment Arrangement.....	154

Latitude Printable Help

Override a Payment Spread	156
Payment Instruments.....	158
Reschedule a Payment Arrangement	166
Place All Scheduled Arrangements on Hold.....	168
Approve or Deny a SIF Arrangement	169
Account Selection	170
Payment Spread Selection	170
Settlement Selection.....	171
Payment Arrangement Types	172
Payment Arrangement Scenarios	172
Arrangement Negotiator States.....	173
Surcharge Rules.....	175
Payments.....	175
Payments.....	175
Process a Payment	175
Process a Payment Batch	176
View Payment Batch History.....	179
View Applied and Planned Payments	181
Payment Type Codes.....	183
Payment Status	184
Letters	185
Letters	185
Request a Letter.....	185
Select Accounts	186
View Pending Letter Requests	188
Delete a Pending Letter Request	189
Suspend a Pending Letter Request	189
Release the Hold on a Pending Letter Request.....	189
View Letter Details.....	190
View Letter History	191
Letter Types	192
Legal Case.....	192

Legal Case.....	192
Maintain General Legal Information.....	192
Assign a Court	194
Judgments.....	195
Garnishments.....	205
Accounting	209
Delete a Legal Case	213
Care and Financial Hardship	213
Care and Financial Hardship	213
Add a Care or Financial Hardship Case	214
Modify a Care or Financial Hardship Case	216
Approve Care and Financial Hardship Hold Days.....	218
Complaints	219
Complaints	219
Add a Complaint.....	219
Modify a Complaint.....	221
Select Accounts to Associate to the Complaint	223
Remove a Duplicate Complaint.....	224
Remove a Complaint From an Account	224
Remove a Non-Complaint Document	225
Close a Complaint	225
Reopen a Complaint.....	226
Disputes	226
Disputes	226
Add a Dispute.....	226
Modify a Dispute.....	227
Remove a Duplicate Dispute	228
Remove a Non-Dispute Document	229
Close a Dispute.....	229
Reopen a Dispute.....	229
RDN Integration	230
RDN Integration	230

Latitude Printable Help

View Summary Data for an RDN Case.....	230
View RDN Case Detail and Update History	231
Create an RDN Case	233
Modify Addresses and Phone Numbers on an RDN Case.....	235
Retrieve Case Updates From RDN.....	237
Send a Case Update to RDN	238
Case Updates	239
Place an RDN Case on Hold.....	240
Release the Hold on an RDN Case.....	241
Close and Reassign an RDN Case	242
Close an RDN Case	244
Reference Panels.....	246
Reference Panels.....	246
Addresses.....	246
Addresses	246
View Addresses	246
Add an Address	247
Modify an Address	248
AIM.....	250
AIM.....	250
View General AIM Information.....	250
View AIM History	251
View AIM History Details	252
View AIM Requests and Notifications.....	252
Create an AIM Request	253
Create an AIM Response.....	254
View AIM Arrangements.....	254
View AIM Work Efforts	255
View Arrangement History	256
Automotive	256
Automotive	256
Maintain Automotive Collateral Information	256

Maintain Automotive Repossession Information	258
Automotive Auction	260
Maintain Automotive Lease Information.....	264
Collateral.....	265
Collateral	265
Maintain Vehicle Collateral Information.....	265
Maintain Repossession Information	268
Auction.....	271
Maintain Lease Information.....	279
Maintain Real Estate Collateral.....	281
Communication.....	283
Communication.....	283
View Account Communications	283
Play a Call Recording	284
View a Sent Letter	285
View Interaction Details for a Communication.....	285
Credit Bureau Reporting	286
Credit Bureau Reporting	286
Configure a Responsible Party for Credit Reporting.....	286
View Credit Bureau Reporting Summary	287
View Credit Bureau Reporting Account Information.....	289
View Credit Bureau Reporting Audit Trail.....	291
Manage Miscellaneous CBR Settings	292
Report an Account to Credit Bureaus	293
Delay Reporting an Account to Credit Bureaus	294
Evaluate an Account for Credit Reporting	296
Remove a Responsible Party From Credit Bureau Reporting	296
Send Delete Request for Account Reported in Error.....	298
Send Delete Request for Account Reported Based on Fraud	299
Send Delete Request for Medical Account	300
Undo a Credit Reporting Delete Request.....	301
Credit Bureau Reporting Codes	302

Latitude Printable Help

Custom Panel	319
Custom Panel	319
Create a Custom Panel.....	319
View a Custom Panel	320
Documentation	321
Documentation	321
Attach a Document to an Account.....	321
View Documents Attached to an Account.....	322
Download a Document	322
Delete a Document From an Account.....	322
Email Addresses	323
Email Addresses	323
View Email Addresses	323
Add an Email Address	323
Modify an Email Address	325
Change the Status of an Email Address	326
Email Consent Icons	326
Email Status Icons	326
Extra Data.....	327
Extra Data.....	327
Add Extra Data	327
Modify Extra Data	327
Fusion Service History.....	328
Fusion Service History.....	328
View Fusion Service History	328
Verify a Response From an Outside Service Provider.....	329
Income and Expenditures	330
Income and Expenditures	330
Add Financial Summary Information	330
Add Income	332
Add Expenses	333
Add Arrears	335

View Income and Expenditure History	337
Interactions and Events	338
Interactions and Events	338
View Account Interactions	338
View Events for an Account	339
Interaction Icons	340
Medical.....	340
Medical.....	340
Add Patient Information	341
Modify Patient Information	342
Add an Insurance Policy	344
Modify an Insurance Policy	347
Invalidate an Insurance Policy.....	349
Add Next of Kin	350
Modify Next of Kin	350
Add a Medical Facility	351
Modify a Medical Facility	352
Miscellaneous Extra Data.....	353
Miscellaneous Extra Data.....	353
Add Miscellaneous Extra Data	354
Modify Miscellaneous Extra Data	354
Notes.....	355
Notes.....	355
View Account Notes.....	355
Add an Account Note	356
Redact an Account Note Comment	357
Action and Result Codes	358
Payment History.....	360
Payment History.....	360
View Payment History for an Account	360
View Payment History Detail for an Account.....	360
Phones.....	362

Latitude Printable Help

Phones.....	362
View Phone Numbers for an Account.....	362
Add a Phone Number to an Account	363
Modify a Phone Number on an Account	364
Change the Status of an Account Phone Number	366
Dial a Phone Number	366

Introduction to Latitude

The Latitude collections solution has comprehensive debt collection and recovery capabilities for managing all pre- and post-charge-off accounts and workflow processes. It provides collectors and agents with the tools to manage the debt collection and recovery process. It also provides supervisors, managers, administrators, and support staff with the tools to manage Latitude.

Latitude provides the full functionality for the collector's or agent's desktop and deploys as a true zero-footprint, browser-based environment.

Latitude allows you to:

- Maintain account and contact information.
- Track account activities.
- Record account notes.
- Set account reminders and follow-up dates.
- Schedule and process payments.

What's New in Latitude

For more information about the changes and enhancements in Latitude, see the following:

2020 R1

2020 R1 introduced the following changes and enhancements in Latitude.

Permissions

- Added Allow RDN Case Creation and Updates permission for specifying whether users can create and update RDN collateral recovery cases on the **RDN Integration** panel.
- Added Allow Collateral Editing Permission for specifying whether users can modify automotive and non-automotive collateral information on the **Collateral** panel.
- Added **Manual Dial Policy** to Dialer Permission to allow users to place calls manually through the Genesys Cloud client. (For Genesys Cloud integrations only.)
- Added Phone Type Mapping Permission for mapping phone types to action codes.
- Added RDN Service Configuration for specifying the URL and API key for retrieving RDN collateral recovery case updates.

Genesys Cloud integration

Added ability to integrate Latitude with Genesys Cloud™ for Dialer capabilities that allow collectors to process campaign calls based on call lists that your organization creates using List Builder. For more information, see [Latitude Integration with Genesys Cloud](#).

Reference panels

- Added ability to maintain automotive and non-automotive collateral information for an account. For more information, see [Collateral](#).

Note: This panel replaces the **Automotive** panel.

- Added ability to open a web page inside a custom reference panel and display mapped content within the web page. For more information, see [Add a Custom Anchor Card or Reference Panel](#).

System codes and settings

- Added ability to specify a user's credentials for a third-party system to log on the user to the third-party system automatically. For more information, see [Add a User and Modify a User](#).
- Added user-defined list codes for the following:
 - Bankruptcy Reaffirm Method
 - Bankruptcy Status
 - Bankruptcy Surrender Method
 - Prefix
 - Suffix

For more information, see List Codes.

Task panels

Added ability to create and update RDN collateral recovery cases. For more information, see [RDN Integration](#).

2020 R2

2020 R2 introduced the following changes and enhancements in Latitude.

Account Analysis

Added ability to create queries to retrieve accounts that meet specific criteria. Also, allows you to sort, group, and summarize the information for review. For more information about account analysis, see Account Analysis.

Permissions

- Added Access Account Analysis Permission for specifying whether users can create and update Account Analysis Query.
- Added User Restrictions by Conditions Permission to restrict the accounts that the user can modify using Account Analysis.

Account Reactivation

Added ability to reinstate an account and unreturn an account. For more information about reinstate and unreturn, see Reinstating an Account and Unreturning an Account.

Permissions

- Added Access Reopen Account Permission for reinstating an account.
- Added Access Unreturn Account Permission for unreturning an account.
- Added Email Request Permission for emailing a letter.
- Added Print Request Permission for printing a letter.
- Added SMTP Permission for email messages.
- Added Bankruptcy Permission for modifying or deleting bankruptcy data.
- Added Deceased Permission for modifying or deleting deceased data.
- Added My Desk Assignment Permission for reassigning an account to desk.

Task panels

- Added ability to email a letter. For more information, see Email a Letter.
- Added ability to print a letter. For more information, see Print a Letter.

Log On to Latitude

Use the **Logon** page to log on to Latitude. Your assigned permissions determine which options and features in Latitude are available to you. For more information, see [Permissions and Policies](#).

To log on to Latitude

1. Open Latitude in your browser. The **Latitude by Genesys Logon** page appears.

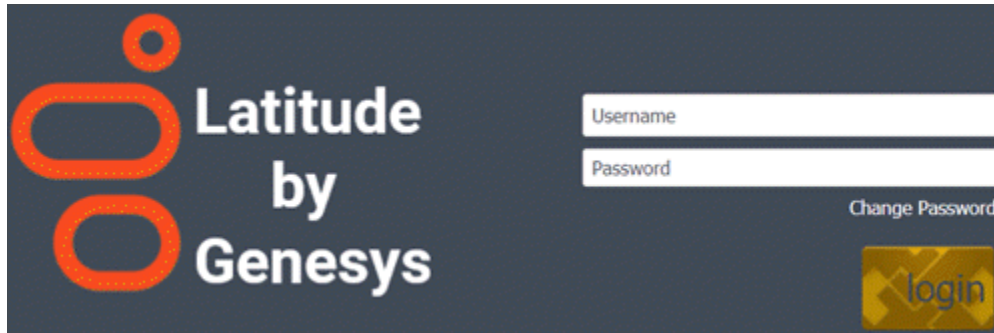

2. Do one of the following:

- If you have a user ID and password specifically for Latitude, type them in the boxes and then click **Log On**.

Note: As you type your password, periods display instead of the typed characters. If your password expires, the system requires you to change it. For more information, see [Change Your Password](#).

- If your organization configured Latitude to allow an external logon (for example, your network credentials), leave the **Username** and **Password** boxes blank and click **External Log On**. If you aren't logged on externally, the system redirects you to your identity provider and prompts you to provide your credentials.

If your credentials are correct, the **Latitude by Genesys** page appears. Otherwise, an error message appears; provide the correct credentials or contact your system administrator for assistance.

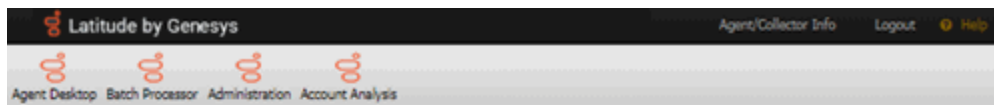

Version: 20.2.0.82 | DB Server Name: ase512dev.qfun.com | Database: Collect2000

- To view information about the system (such as assembly versions for each component on the web server), click the version number in the status bar. The **About Interaction Collector** dialog box appears. This information is useful for troubleshooting deployments.

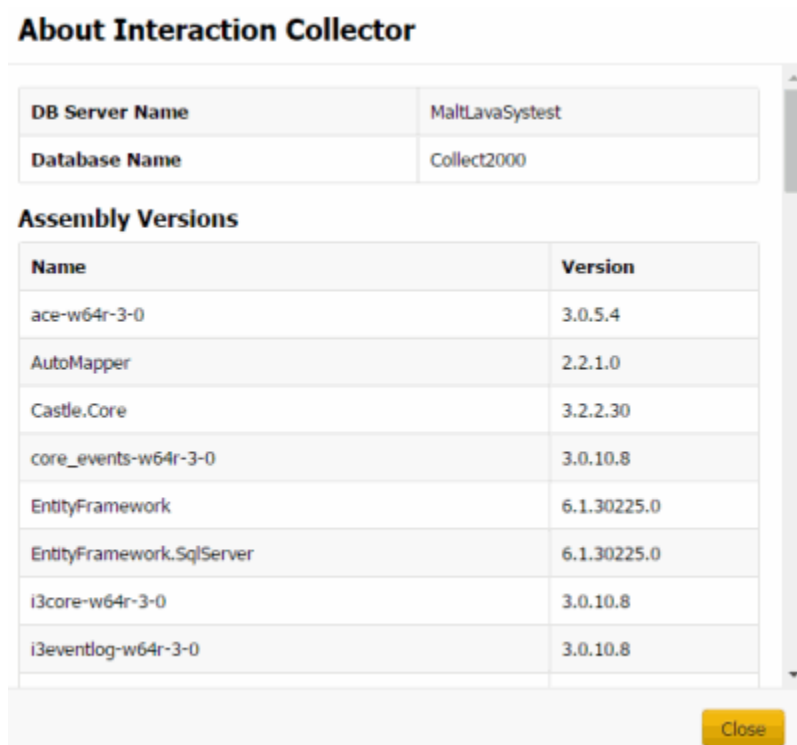

- Do one of the following:
 - To view or work an account, click **Agent Desktop**. A new browser tab opens. If any account interactions remained open when you last logged off, the **Open Interactions** panel appears. Otherwise, the **Search Accounts** panel appears. For more information, see [Account Retrieval](#).
 - To process a batch of payment transactions (provided you have the appropriate permissions), click **Batch Processor**. For more information, see [Process a Payment Batch](#).
 - To configure system codes, settings, permissions, and policies (provided you have the appropriate permissions), click **Administration**. For more information, see System Administration.

Change Your Password

Use the **Change Password** dialog box to change your Latitude password. If your password is close to the expiration date (based on the Password Expiration permission setting), a warning appears under the **Change Password** link.

To change your password

1. Open Latitude in your browser. The **Latitude by Genesys Logon** page appears.

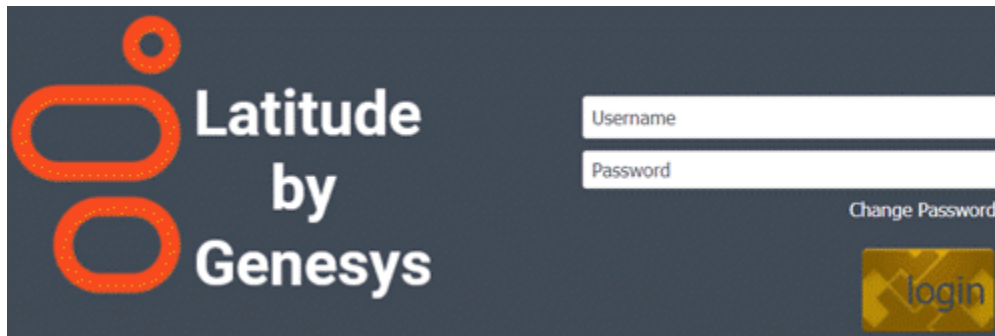

2. Click **Change Password**. The **Change Password** dialog box appears.

Change Password

Login Name	<input type="text" value="Login Name"/>
Current Password	<input type="password" value="Current Password"/>
New Password	<input type="password" value="New Password"/>
Confirm New Password	<input type="password" value="Confirm New Password"/>

3. In the **Login Name** box, type your user ID.
4. In the **Current Password** box, type your current password.
5. In the **New Password** box, type your new password.
Tip: To view the requirements for creating a password, click **Password Hint**.
6. In the **Confirm Password** box, retype your new password.
7. Click **Change Password**.

Work Form Overview

The **Work Form** is the main page in Latitude, and it consists of several sections. Each section allows you to perform specific actions related to that section.



Note: A red asterisk (*) next to a field indicates a required field.

1. **Application toolbar:** Displays options for viewing the **Welcome** page, logging off Latitude and viewing the documentation. When processing a request, a yellow progress bar appears along the top edge of this toolbar and a circulating progress indicator appears next to the logo.
2. **Account toolbar:** Displays options for displaying and working an account.
3. **Delinquency or Recovery anchor:** Displays delinquency or recovery information for the selected account, depending on how your organization configured your system.
4. **Account Detail toolbar:** Displays options for viewing detail and summary information for the selected account.
5. **Task Panel navigation tree:** Displays the available task panels and allows you to open them.
6. **Task panel:** Displays the selected task panel.

7. **Reference Panel navigation bar:** Allows you to open and close reference panels.
8. **Reference Panel toolbar:** Displays options for the selected reference panel.
9. **Reference panel:** Displays the selected reference panel.
10. **Status bar:** Displays the following system and account status information:
 - **DB Server Name:** Name of the Latitude database server.
 - **Database:** Name of the Latitude database.
 - **Previous Login:** Date and time you last logged on to Latitude.
 - **Time on Account:** Length of time that you've spent on this account. If the background color is gray, you haven't reached the threshold set for the **caution** or **warning** zones. If the background color is yellow, you've reached the threshold set for the **caution** zone. If the background color is red, you've reached the threshold set for the **warning** zone. For more information, see the **Time on Account Configuration** permission.
 - **Queue Progress:** Number of accounts in the work queue. This value only appears when you are working accounts in a queue.
 - **Alerts:** Number of issues related to the account. To view details about the alert, click **Alerts**. If you receive this message, "An error has occurred. If this problem persists, please contact Technical Support," you can view the details by clicking **Alerts**.

Icons

An icon allows you to perform a specific action. The following icons are available on the **Work Form**:

Icon	Name	Description
	Search Slide-in	Displays and hides the Search & Queue Selection panel, which allows you to search for and display accounts. The Search slide-in is on the Account toolbar.
^	Collapse	Collapses a section of the Work Form to hide its contents.
v	Expand	Expands a section of the Work Form to display its contents.
	Filter	Limits information in a data grid based on criteria you specify.

Form state

When you attempt to save information, the background of the "save" section of the panel you are working changes color to indicate the status of the attempted save.

Color	Description
Gray	Default color that indicates the user hasn't requested a "save" action yet.
Blue	Indicates the "save" action is processing.

Latitude Printable Help

Green	Indicates the "save" action completed without errors.
Red	Indicates that there was an error completing the "save" action.

Help Overview

Latitude help provides you with information for using Latitude. You can locate and view help topics using the table of contents, index, and search features. You can also open help within certain areas of Latitude (for example, panels and dialog boxes) to view context-appropriate information.

To open Latitude help

- In the **Application** toolbar, click **Help**. The help opens with the introductory topic and table of contents displayed.

Note: To open the help to a context-appropriate topic, in the panel or dialog box you have open currently, click **Help**. The corresponding topic appears in a separate window. To display the table of contents, at the bottom of the help window, click **Show**.

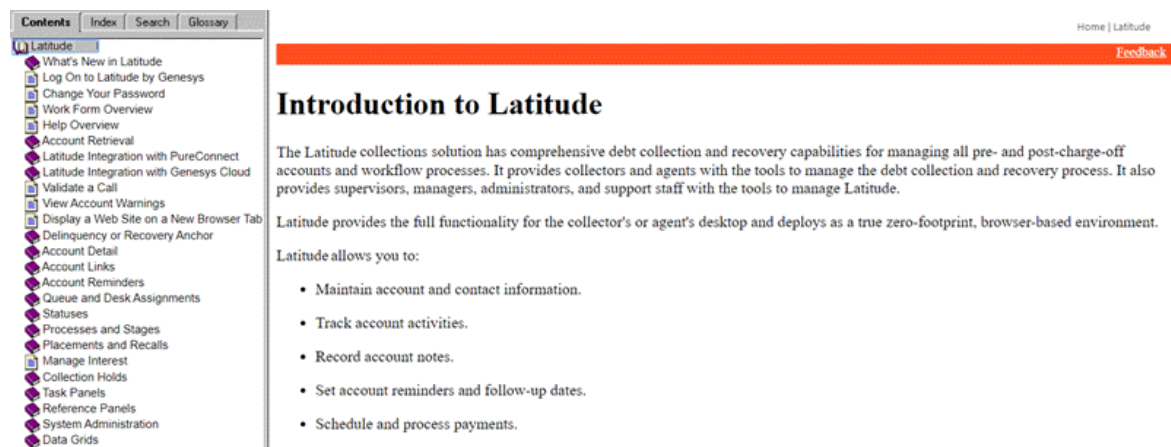

Tip: To adjust the width and height of the window or its panes, click the edge of the window or pane and drag it up or down, left or right.

1. **Toolbar:** Allows you to display the table of contents, index, search feature, or glossary. When you click an option in the toolbar, the corresponding information appears in the **Navigation** pane.
2. **Navigation pane:** Displays the following:

Contents: Displays the table of contents. To display a topic in the **Content** pane, expand a book and then click the link.

Index: Displays the index. To display a topic in the **Content** pane, type a keyword or phrase in the box (or scroll through the list) and then click the link in the list.

Search: Displays the [search feature](#). To display a topic in the **Content** pane, type a keyword or phrase in the box and then press **Enter**. In the search results, click the link.

Glossary: Displays a glossary of terms and definitions. To display a definition, click the term.

3. **Breadcrumbs:** Displays your current location within the help system. When you click a breadcrumb, the related topic displays.
4. **Content toolbar:** Displays an option for sending feedback through an email message to Latitude by Genesys Documentation.

5. **Content pane:** Displays the contents of a topic. To display recently visited topics, use your browser's **Back** and **Forward** options. To view the **Content** pane menu, right-click in the **Content** pane.

Search feature

You can use the search feature to locate topics that contain words or phrases that you specify. You formulate a search query following a specific [set of rules](#). You can include [wildcard expressions](#), [Boolean operators](#), and [nested expressions](#) in your search query. A list of topics that match your search criteria appear in the search results. When you click a topic title in the search results, the content of that topic appears in the **Content** pane.

Search syntax

The basic rules for formulating search queries are:

- Searches are not case-sensitive, meaning you can type uppercase or lowercase characters.
- You cannot search for a single character or the following reserved words: an, and, as, at, be, but, by, do, for, from, have, he, in, it, not, of, on, or, she, that, the, there, they, this, to, we, which, with, you.
- The search engine ignores punctuation marks and special characters such as @#\$%^&()=+[]\.
- Enclose phrases and terms that include a period (such as a file name with an extension) in double quotation marks.

Wildcard expressions

Wildcard expressions allow you to search for one or more characters using a question mark or asterisk. A question mark represents a single character, while an asterisk represents one or more characters.

Search for...	Example	Result
Topics with text that starts with one or more specified characters and ends in any character or number of characters	log or log*	Returns all topics with text that starts with the specified characters (for example, log, logon, logging).
Topics with text that starts with the specified characters, has a single character that can be anything, and ends in the specified characters	32?57	Returns all topics with text that has any character where you placed the question mark (for example, 32?57 returns 32257, 32457, and 32857).
Topics that contain all the words specified, in any order or placement within the topic	account status	Returns all topics with both account and status, but not necessarily as a phrase or in the order specified. For example, the search returns topics with "the account status..." or "the status of the account..."

Topics that contain the specified phrase	"account status"	Returns all topics with account status as a phrase. For example, the search returns topics with "the account status..." but not "the status of the account..."
--	------------------	--

Boolean operators

Boolean operators (AND, OR, NOT, NEAR) allow you to create a relationship between terms. If you don't specify an operator, the system uses AND by default.

Search for...	Example	Result
AND	account AND status	Returns all topics with both account and status, but not necessarily as a phrase or in the order specified. For example, the search returns topics with "the account status..." or "the status of the account..."
OR	account OR status	Returns all topics with either account or status, or both.
NOT	account NOT status	Returns all topics with account but not status.
NEAR	account NEAR status	Returns all topics where account is within eight words of status.

Nested expressions

Nested expressions allow you to perform complex searches. For example, queue AND ((collector OR clerical) not supervisor) finds topics containing queue and collector but not supervisor, or containing queue and clerical but not supervisor. As with mathematical expressions, the system evaluates expressions in parentheses first. If there is no parenthesis, the system evaluates the expression from left to right. For example, queue NOT (clerical OR supervisor) finds topics containing queue but not clerical or supervisor. Queue NOT clerical OR supervisor finds topics containing queue but not clerical, or topics containing supervisor.

Screen captures

Many topics contain a snapshot of the related application page. Use this sample graphic as a frame of reference to match the application page to the help topic. What you see displayed in the application may differ, depending on your system configuration, your permissions, and the options you select.

Account Retrieval

Account Retrieval

There are several methods available for retrieving and displaying an account. The methods include:

- Searching for an account and selecting it from the search results.
- Selecting an account from open interactions.
- Opening a work queue of accounts.
- Selecting an account from your inventory.
- Selecting an account from your account history list.

All the retrieval methods require you to click the Search slide-in icon .

Search

Account Search

Use the **Search Accounts** panel to search for an account based on specific search criteria and display it. Latitude uses wildcard searching for most criteria. For example, if you don't know the precise spelling of a name, you can type one or more characters in the **Name** box and search on a partial name. Latitude returns all records where the name begins with the specified characters. For example, "SMIT" returns "SMITH," "SMITHERS," and "SMITLEY."

Search for an Account

Use the **Simple** tab in the **Search Accounts** panel to search for an account using any combination of search criteria. If you don't have the Access Account Permission, you cannot view the account.

To search for an account

1. If the **Search & Queue Selection** panel isn't visible, click the Search slide-in icon. The **Search & Queue Selection** panel appears.
2. In the menu bar, click **Search Accounts** and then click the **Simple** tab.

Interactions	Search Accounts	Open Work Queues ▾	Inventory	Account History
Simple		Results		
File Number:	<input type="text"/>			
Account:	<input type="text"/>			
Address:	<input type="text"/>			
Bankruptcy:	<input type="text"/>			
Branch:	<input type="text"/>			
City:	<input type="text"/>			
Court Case:	<input type="text"/>			
Client:	<input type="text"/>			
Customer ID:	<input type="text"/>			
Customer ID #1:	<input type="text"/>			
Customer ID #2:	<input type="text"/>			
Purn:	<input type="text"/>			
Department:	<input type="text"/>			
Desk:	<input type="text"/>			
Garnishment:	<input type="text"/>			
ID #1:	<input type="text"/>			
ID #2:	<input type="text"/>			
Name:	<input type="text"/>			
National Id:	<input type="text"/>			
Phone:	<input type="text" value="US"/>			
Postal Code:	<input type="text"/>			
State:	<input type="text"/>			
Status:	<input type="text"/>			
Team:	<input type="text"/>			
<input type="button" value="Search"/>		<input type="button" value="Clear"/>		
<input type="button" value="Help"/>				

The system only displays the search criteria that your permissions allow. Search criteria could include one or more of the following:

- File Number:** Unique code that the system assigned to identify the account. The system doesn't allow wildcard searching on the file number.

- **Account:** Code that the client assigned to identify the account. You can specify a partial account number to have the system do a wildcard search.
- **Address:** First line of the customer's street address. You can specify a partial street address to have the system do a wildcard search.
- **Bankruptcy:** Case number the court assigned to the bankruptcy.
- **Branch:** Code that identifies the branch, or the branch name. You can specify a partial branch name to have the system do a wildcard search. The system doesn't allow wildcard searching on the branch code. If you specify five characters, the system searches for an exact match to the branch code. If you specify fewer than five characters or more than five characters, the system does a wildcard search on the branch name.
- **City:** City that is part of the customer's address. You can specify a partial city name to have the system do a wildcard search.
- **Client:** Unique code that your organization assigned to identify the client, or the client name. You can specify a partial client name to have the system do a wildcard search. The system doesn't allow wildcard searching on the client code. If you specify seven characters, the system searches for an exact match to the client code. If you specify fewer than seven characters or more than seven characters, the system does a wildcard search on the client name.
- **Court Case:** Case number the court assigned to the court case.
- **Customer ID:** Identification number associated to a party on an account. You can specify a partial ID number to have the system do a wildcard search.
- **Customer ID #1:** Identification number associated to a party on an account. You can specify a partial ID number to have the system do a wildcard search.
- **Customer ID #2:** Identification number associated to a party on an account. You can specify a partial ID number to have the system do a wildcard search.
- **Department:** Code that identifies the department that your organization assigned to a branch. You can specify a partial department name to have the system do a wildcard search.
- **Desk:** Code that identifies the desk, or the desk name. You can specify a partial desk name to have the system do a wildcard search. The system doesn't allow wildcard searching on the desk code. If you specify 10 characters, the system searches for an exact match to the desk code. If you specify fewer than 10 characters or more than 10 characters, the system does a wildcard search on the desk name.
- **Garnishment:** Case number the court assigned to the garnishment.
- **ID #1:** Identification number associated to an account. You can specify a partial ID number to have the system do a wildcard search.
- **ID #2:** Identification number associated to an account. You can specify a partial ID number to have the system do a wildcard search.

- **Intl Phone:** Any international phone number on the account. You can specify a partial non-formatted phone number to have the system do a wildcard search for a phone number that doesn't have a "bad" phone status.
- **Name:** Customer's name or business name. You can search on the first name only, last name only, the first name with last name, or business name. You can specify a partial or full name. For example, if you type "John" in the box, the system does a wildcard search for "John" as a first name, last name, or business name.
- **National ID:** Unique number the government issues to identify a person (for example, social security number or state ID). You can specify a partial ID number to have the system do a wildcard search. If you specify four characters exactly, the system also attempts to match the last four characters.
- **Phone:** Any phone number on the account. You can specify a partial non-formatted phone number to have the system do a wildcard search for a phone number that doesn't have a "bad" phone status. You can also use % and _ wildcard characters.
- **Postal Code:** Postal code that is part of the customer's address. You can specify a partial postal code to have the system do a wildcard search.
- **PURN:** Personal Unique Record Number. Alphanumeric code that an outside provider such as a credit bureau assigns to identify a person. You can specify a partial ID number to have the system do a wildcard search.
- **State:** State that is part of the customer's address. The system attempts an exact match only.
- **Status:** Code that identifies the status of the account, or the status description. You can specify a partial status description to have the system do a wildcard search. The system doesn't allow wildcard searching on the status code. If you specify five characters, the system searches for an exact match to the status code. If you specify fewer than five characters or more than five characters, the system does a wildcard search on the status description.
- **Team:** Name of the team that your organization assigned to a department. You can specify a partial team name to have the system do a wildcard search.

3. Type search criteria into one or more boxes and then click **Search**. The results display on the **Results** tab.

4. To clear the search criteria, click the **Simple** tab and then click **Clear**.

Select an Account From Search Results

Use the **Results** tab in the **Search Accounts** panel to view the results of your search and select an account to display.

To select an account from search results

1. In the **Search Accounts** panel, click the **Results** tab.

Latitude Printable Help

File Number	Link Number	Queue Level	Queue Date	Client	Original Creditor	Account Number	Account Number (Masked)	ID1	ID2	Status	Desk	Charge Off Date	Delinquency Date	Received Date	Last Worked Date	Last Contacted Date	Original Balance	Original Principal	Current Balance
1002	3	015	11/03/2014	0000001	PNC BANK	045313MB01	*****MB01			NEW - NEW STATUS ** (Active)	ADMIN	01/25/2009	01/25/2009	02/11/2011			\$819.47	\$819.47	\$819.47

The system displays the search result columns that your permissions allow.

2. If the search results exceed the maximum allowed to display on a single page, click a page number to display its contents. You can also click **Previous** and **Next** to move between pages.
3. To display an account, click a link in one of the columns. The following outcomes are possible:
 - If your organization requires you to validate information with the caller before displaying the account, the **Data Protection** dialog box appears. Verify the information with the caller and then click **Validated**. If you click **Not Validated**, the system doesn't display the account.
 - If there are warnings for the account, the **Warnings** dialog box appears. Review the warnings and then click **OK**.
 - The account displays.

Locate an Account Using Quick Search

Use the quick search feature to locate an account using a single search criteria. For more information, see [Quick Search Codes](#).

To locate an account using quick search

1. In the **Account** toolbar, do one of the following:
 - In the list box, click a search code.
 - In the **Search** box, type the code (for example, "F" for file number) and then press **Tab**. The system populates the list box with the specified code.

2. In the **Search** box, type the value.

Note: If you are searching by international phone number, click the country code in the list box within the **Search** box and then type the phone number.

3. Press **Enter** or click the Search icon. If multiple records match, the results appear on the **Results** tab. If a single record matches, the following outcomes are possible:
 - If your organization requires you to validate information with the caller before displaying the account, the **Data Protection** dialog box appears. Verify the information with the caller and then click **Validated**. If you click **Not Validated**, the system doesn't display the account.

- If there are warnings for the account, the **Warnings** dialog box appears. Review the warnings and then click **OK**.
- The account displays.

Quick Search Codes

Quick search codes allow you to search for an account based on a single search criteria. The following codes are available when using the quick search feature:

Code	Description
A	Customer account number
D	Driver's license number
D1	Customer ID 1
D2	Customer ID 2
DID	Customer ID
DP	Customer PURN
F	File number
ID1	ID 1
ID2	Customer ID 2
P	Phone number
PI	International phone number
S	National ID (for example, Social Security Number)
V	Vehicle ID (for example, VIN)

Open Interactions

Open Interactions

Use the **Open Interactions** panel to view a list of accounts that have open interactions. An interaction remains open until one of the following occurs:

- You close the interaction using the **Close** or **Close All** options in the **Open Interactions** panel.

- You close the interaction using the **Close Account** option in the **Account** toolbar.

Note: If you have the **Auto Close Account** permission, the following actions close an open interaction automatically.

- You search for and select an account using the [Search Accounts](#) or [Quick Search](#) feature.
- You move to the next account in the [work queue](#) when working accounts in a queue.
- You [close the work queue](#) when working accounts in a queue.
- You [select another account from inventory](#).
- You [select another account from account history](#).

Note: If you leave an interaction open for 30 minutes or longer, other users can open that interaction.

View Open Interactions

Use the **Open Interactions** panel to view all the accounts that have open interactions. For information about how long interactions remain open, see [Open Interactions](#).

Note: If you just logged on to Latitude and you have open interactions, the **Open Interactions** panel displays automatically.

To view open interactions

1. If the **Search & Queue Selection** panel isn't visible, click the Search slide-in icon. The **Search & Queue Selection** panel appears.
2. In the menu bar, click **Interactions**.

File Number	Name	Started	Last Activity	Since	
1006	Willie Davis	4/25/18 8:52 am	4/25/18 8:53 am	00:01:55	Close
1007	Brad Fry	4/25/18 8:53 am	4/25/18 8:53 am	00:00:51	Close
1005	Roy Wiesen	4/25/18 8:51 am	4/25/18 8:52 am	00:03:00	Close

Previous 1 Next

File Number: Unique code that the system assigned to identify the account.

Name: Name of the customer associated to the account.

Started: Date and time an interaction started on the account.

Last Activity: Date and time the last activity occurred on the account.

Since: Length of time that you've had the interaction open. If the background color is green, you haven't reached the threshold set for the **caution** or **warning** zones. If the background color is

yellow, you've reached the threshold set for the **caution** zone. If the background color is red, you've reached the threshold set for the **warning** zone. For more information, see **Time on Account Configuration** permission.

Close: Closes the interaction.

Select an Account From Open Interactions

Use the **Open Interactions** panel to select an account to display.

To select an account from open interactions

1. If the **Search & Queue Selection** panel isn't visible, click the Search slide-in icon. The **Search & Queue Selection** panel appears.
2. In the menu bar, click **Interactions**.

File Number	Name	Started	Last Activity	Since	
1006	Willie Davis	4/25/18 8:52 am	4/25/18 8:53 am	00:01:55	Close
1007	Brad Fry	4/25/18 8:53 am	4/25/18 8:53 am	00:00:51	Close
1005	Roy Wiesen	4/25/18 8:51 am	4/25/18 8:52 am	00:03:00	Close

Previous 1 Next

3. In the **File Number** column, click the account. The following outcomes are possible:
 - If your organization requires you to validate information with the caller before displaying the account, the **Data Protection** dialog box appears. Verify the information with the caller and then click **Validated**. If you click **Not Validated**, the system doesn't display the account.
 - If there are warnings for the account, the **Warnings** dialog box appears. Review the warnings and then click **OK**.
 - The account displays.

Close an Open Interaction

Use the **Open Interactions** panel or the Account toolbar to close a single or all open interactions.

To close an open interaction

1. To close an interaction for the account that is open currently, in the **Account** toolbar, click **Close Account**.
2. To select an open interaction to close, do the following:
 - a. In the **Account** toolbar, click the Search slide-in icon.

- b. In the menu bar, click **Interactions**.

File Number	Name	Started	Last Activity	Since	
1006	Willie Davis	4/25/18 8:52 am	4/25/18 8:53 am	00:01:55	Close
1007	Brad Fry	4/25/18 8:53 am	4/25/18 8:53 am	00:00:51	Close
1005	Roy Wiesen	4/25/18 8:51 am	4/25/18 8:52 am	00:03:00	Close

Previous 1 Next

- c. In the data grid, click **Close**.
3. To close all open interactions, click **Close All**.

Work Queues

Work Queues

Use the queue panels to open a work queue and begin working accounts in the order that Latitude presents them. Queues only include accounts flagged as "should queue." They don't include non-driver linked accounts, but they do include their account balances in the totals for the driver account that appears in the queue. While you have an account open, the status bar displays the number of accounts in the queue.

The following queues are available, depending on your permissions:

- **Collector queue:** Contains accounts assigned to a queue level that is less than 599. The Collector queue sorts accounts within each desk by the queue date (oldest to newest) and then within each queue date by the queue level (lowest to highest). Users specify the desk (their own or with permissions, another user's desk) of accounts to work and can limit the accounts to a specific client or all clients. Users then open the Collector queue for all the filtered accounts, only the filtered accounts for a specific queue date, or only the filtered accounts for a specific queue date and queue level.
- **Custom queue:** Contains accounts assigned to queue levels 425-499 that require a specific type of work (for example, skip tracing). The Custom queue sorts accounts by queue level from lowest to highest. Users open the Custom queue for accounts with a specific queue level.
- **Clerical queue:** Contains accounts assigned to queue levels 600-699 that require clerical support (for example, verification of a direct payment). The Clerical queue sorts accounts by queue level from lowest to highest. Users open the Clerical queue for accounts with a specific queue level.
- **Supervisor queue:** Contains accounts assigned to queue levels 700-799 that require supervisor support (for example, approval of a payment arrangement). The Supervisor queue sorts accounts by queue level from lowest to highest. Users open the Supervisor queue for accounts with a specific queue level.

Open the Collector Queue

Use the **Collector Queue** panel to select a group of accounts in the Collector queue and display the accounts one at a time based on the sort order.

To open the Collector queue

1. If the **Search & Queue Selection** panel isn't visible, click the Search slide-in icon. The **Search & Queue Selection** panel appears.
2. In the menu bar, click **Open Work Queues** and then click **Collector**. The **Collector Queue** panel appears.

Collector Queue

Desk: 0000000 - ADMI...

Client(s): All Clients

Filter

Queue	Accounts	Balance	Worked
All Accounts	348	\$529,138.72	1
05/10/2011	1	\$2,467.42	1
08/19/2011	1	\$2,067.89	0
09/23/2011	1	\$5,000.00	0
10/30/2014	345	\$519,603.41	0

Open

Help

Desk: Desk for which to display accounts. This list box is available if you have permission to work other collector desks.

Client(s): Clients for which to display accounts.

Filter: Click to display the accounts for the specified desk and clients.

Queue: Date the system or a user assigned the account to the Collector queue.

Accounts: At the All Accounts level, the total number of accounts. At the Date level, the total number of accounts with that queue date. At the Queue Level, the total number of accounts with that queue level.

Balance: At the All Accounts level, the total balance on all the accounts. At the Date level, the total balance on the accounts with that queue date. At the Queue Level, the total balance on the accounts with that queue level.

Worked: At the All Accounts level, the total number of times someone worked the accounts. At the Date level, the total number of times someone worked the accounts with that queue date. At the Queue Level, the total number of times someone worked the accounts with that queue level.

3. In the **Desk** box, click the desk for which to display accounts.
4. Do one of the following:
 - To display accounts for all clients, leave "All Clients" displayed in the **Client** box.

- To specify a client for which to display accounts, click in the **Client** box and then click a client ID and name. Repeat this step to include other clients.

Tip: To clear a client filter, click the **x** next to the client ID and name.

- Click **Filter**. Accounts for the specified desk and clients appear in the data grid.

Collector Queue

Desk:	Queue	Accounts	Balance	Worked
C1 - COLLECTOR ...	All Accounts	46	\$27,645.54	1
	07/19/2011	1	\$2,250.00	1
	07/22/2011	1	\$3,256.23	0
	12/15/2016	44	\$22,139.31	0
	015 - NEW ACCOUNTS	42	\$16,633.08	0
	019 - NPC ACCOUNTS	1	\$3,256.23	0
	120 - OVER 120 DAYS OLD	1	\$2,250.00	1

- Do one of the following:
 - To work all accounts in the queue, click **All Accounts**.
 - To work all accounts in the queue with a specific queue date, expand the **All Accounts** node and then click the queue date.
 - To work all accounts in the queue with a specific date and queue level, expand the queue date node and then click the queue level.
- Click **Open**. The first account in the queue displays.

Notes:

- If your organization requires you to validate information with the caller, the system displays the **Data Protection** dialog box before displaying the account. For more information, see [Validate a Call](#).
- If there are warnings for the account, the system displays the **Warnings** dialog box before displaying the account. For more information, see [View Account Warnings](#).

- To move to the next account in the queue, in the **Account** toolbar, click **Next**.

Note: If your organization requires you to add notes to accounts after working them, you cannot move to the next account until you add a note to the account displayed currently. For more information, see [Add an Account Note](#).

Open the Custom Queue

Use the **Custom Queue** panel to select a Custom queue and display the accounts one at a time based on the sort order.

To open the Custom queue

- If the **Search & Queue Selection** panel isn't visible, click the Search slide-in icon. The **Search & Queue Selection** panel appears.
- In the menu bar, click **Open Work Queues** and then click **Custom**. The **Custom Queue** panel appears.

Custom Queue

	Queue Name	Created	Total	Worked	Available	Should Not Queue
Open	high balance accounts	04/05/2011	15	0	14	1

[Help](#)

Queue Name: Name of the queue.

Created: Date a user created the queue.

Total: Total number of accounts in the queue.

Worked: Number of accounts in the queue that a user has worked.

Available: Number of accounts in the queue that are available to work.

Should Not Queue: Number of accounts that fit the criteria for inclusion in the queue, but the system or a user flagged them for exclusion from the queue.

- Click **Open** next to the queue to open. The first account in the queue displays.

Notes:

- If your organization requires you to validate information with the caller, the system displays the **Data Protection** dialog box before displaying the account. For more information, see [Validate a Call](#).
- If there are warnings for the account, the system displays the **Warnings** dialog box before displaying the account. For more information, see [View Account Warnings](#).

- To move to the next account in the queue, in the **Account** toolbar, click **Next**. The **Custom Queue** dialog box appears.

Note: If your organization requires you to add notes to accounts after working them, you cannot move to the next account until you add a note to the account displayed currently. For more information, see [Add an Account Note](#).

Custom Queue

Would you like to remove this account from the custom queue?

Yes **No** **Cancel**

- Do one of the following:
 - To remove the account from the queue, click **Yes**. The system removes the account from the Custom queue and displays the next account in the queue.

Note: If your organization requires you to set a follow-up date on accounts, the system displays the **Account Follow-up** dialog box before displaying the account. For more information, see [Set an Account Follow-up Date](#).

- To keep the account in the queue, click **No**. The system retains the account in the Custom queue and displays the next account in the queue.
- If you don't want to move to the next account in the queue, click **Cancel**.

Open the Clerical Queue

Use the **Available Clerical Queues** panel to select a Clerical queue and display the accounts one at a time based on the sort order.

Note: For a Clerical queue to function correctly, only allow one user at a time to work the queue. Multiple users working the same Clerical queue at the same time causes system issues.

To open the Clerical queue

1. If the **Search & Queue Selection** panel isn't visible, click the Search slide-in icon. The **Search & Queue Selection** panel appears.
2. In the menu bar, click **Open Work Queues** and then click **Clerical**. The **Available Clerical Queues** panel appears.

Available Clerical Queues

	Queue Level	Description	Count
Open	600	Clerical Support	1

Help

Queue Level: Three-digit code that identifies the queue level. For more information about queue level codes, see Queue Level Codes.

Description: Name of the queue.

Count: Number of accounts in the queue.

3. Click **Open** next to the queue to open. The first account in the queue displays.

Notes:

- If your organization requires you to validate information with the caller, the system displays the **Data Protection** dialog box before displaying the account. For more information, see [Validate a Call](#).
- If there are warnings for the account, the system displays the **Warnings** dialog box before displaying the account. For more information, see [View Account Warnings](#).

4. To move to the next account in the queue, in the **Account** toolbar, click **Next**. The **Clerical Queue** dialog box appears.

Note: If your organization requires you to add notes to accounts after working them, you cannot move to the next account until you add a note to the account displayed currently. For more information, see [Add an Account Note](#).

Clerical Queue

Would you like to remove this account from the clerical queue?

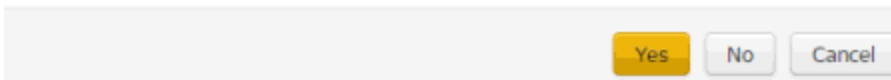

5. Do one of the following:

- To remove the account from the queue, click **Yes**. The system removes the account from the Clerical queue and displays the next account in the queue.

Note: If your organization requires you to set a follow-up date on accounts, the system displays the **Account Follow-up** dialog box before displaying the account. For more information, see [Set an Account Follow-up Date](#).

- To keep the account in the queue, click **No**. The system retains the account in the Clerical queue and displays the next account in the queue.
- If you don't want to move to the next account in the queue, click **Cancel**.

Open the Supervisor Queue

Use the **Available Supervisor Queues** panel to select a Supervisor queue and display the accounts one at a time based on the sort order.

Note: For a Supervisor queue to function correctly, only allow one user at a time to work the queue. Multiple users working the same Supervisor queue at the same time causes system issues.

To open the Supervisor queue

- In the **Account** toolbar, click the Search slide-in icon. The **Search Accounts** panel appears.
- In the menu bar, click **Open Work Queues** and then click **Supervisor**. The **Available Supervisor Queues** panel appears.

Available Supervisor Queues

	Queue Level	Description	Count
Open	700	Supervisor Support	1
Open	701	APPROVE PDC AND PCC	2

Help

Queue Level: Three-digit code that identifies the queue level. For more information about queue level codes, see Queue Level Codes.

Description: Name of the queue.

Count: Number of accounts in the queue.

- Click **Open** next to the queue to open. The first account in the queue displays.

Notes:

- If your organization requires you to validate information with the caller, the system displays the **Data Protection** dialog box before displaying the account. For more information, see [Validate a Call](#).
- If there are warnings for the account, the system displays the **Warnings** dialog box before displaying the account. For more information, see [View Account Warnings](#).

4. To move to the next account in the queue, in the **Account** toolbar, click **Next**. The **Support Queue** dialog box appears.

Note: If your organization requires you to add notes to accounts after working them, you cannot move to the next account until you add a note to the account displayed currently. For more information, see [Add an Account Note](#).

Support Queue

Would you like to remove this account from the supervisor queue?

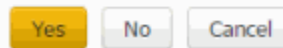

5. Do one of the following:
 - To remove the account from the queue, click **Yes**. The system removes the account from the Supervisor queue and displays the next account in the queue.

Note: If your organization requires you to set a follow-up date on accounts, the system displays the **Account Follow-up** dialog box before displaying the account. For more information, see [Set an Account Follow-up Date](#).

- To keep the account in the queue, click **No**. The system retains the account in the Supervisor queue and displays the next account in the queue.
- If you don't want to move to the next account in the queue, click **Cancel**.

Open the Pool Queue

Use the **Open Work Queues** menu option to open the Pool queue. The Pool queue contains a group of accounts that are available to multiple agents. Unlike static Custom queues, Pool queues are dynamic, with accounts flowing in and out of it as they qualify or disqualify. Accounts in a Pool queue reside on an inventory-type desk, where multiple users have access to them.

To open the Pool queue

1. If the **Search & Queue Selection** panel isn't visible, click the Search slide-in icon. The **Search & Queue Selection** panel appears.
2. In the menu bar, click **Open Work Queues** and then click **Pool**. The first account in the queue displays.

Notes:

- If your organization requires you to validate information with the caller, the system displays the **Data Protection** dialog box before displaying the account. For more information, see [Validate a Call](#).
- If there are warnings for the account, the system displays the **Warnings** dialog box before displaying the account. For more information, see [View Account Warnings](#).

3. To move to the next account in the queue, in the **Account** toolbar, click **Next**. The next account in the work queue appears. Accounts drop out of the Pool queue as users work them. The system doesn't prompt you to remove them.

Notes:

- The system assigns payments to the desk assigned to the account. If you add a promise to an account in the Pool queue, change the desk before applying the payment. Ensure that the system assigned the account to your desk before adding a PDC (post-dated payment).
- If your organization requires you to add notes to accounts after working them, you cannot move to the next account until you add a note to the account displayed currently. For more information, see [Add an Account Note](#).

Close a Work Queue

Use the **Search Accounts** panel to close a queue that is open on the Agent Desktop.

To close a work queue

1. In the **Account** toolbar, do one of the following:
 - Click the Search slide-in icon. In the **Search Accounts** panel, in the menu bar, click **Close Work Queue**. The system closes the queue and the **Search Accounts** panel.
 - Click **Close Queue**. When working a Collector queue, the system closes the queue. When working a Custom, Clerical, or Supervisor queue, the **[Queue Name] Queue** dialog box appears.

Note: If your organization requires you to add notes to accounts after working them, you cannot close the queue until you add a note to the account. For more information, see [Add an Account Note](#).

2. If the **[Queue Name] Queue** dialog box appears, do one of the following:

Clerical Queue

Would you like to remove this account from the clerical queue?

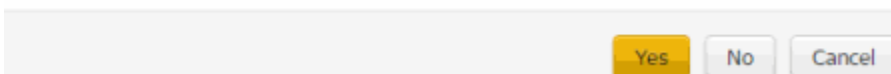

- To remove the account from the queue, click **Yes**. The system removes the account from the queue and closes the queue.

Note: If your organization requires you to set a follow-up date on accounts, the system displays the **Account Follow-up** dialog box before closing the queue. For more information, see [Set an Account Follow-up Date](#).

- To keep the account in the queue, click **No**. The system retains the account in the queue and closes the queue.
- To keep the queue open, click **Cancel**.

History

Account History

Use the **Account History** panel to view accounts worked previously and then select an account to display.

Select an Account From History

Use the **Account History** panel to view accounts previously worked and then select an account to display.

To select an account from history

1. If the **Search & Queue Selection** panel isn't visible, click the Search slide-in icon. The **Search & Queue Selection** panel appears.
2. In the menu bar, click **Account History**. The **Account History** panel appears.

Account History

File Number	Name	Date
1004	ZELLERS Jr, LESLIE E	1/30/15 8:20 am
1035	SAURO, LISA	1/30/15 7:38 am
1033	VALORE, ANTHONY J	1/30/15 7:30 am

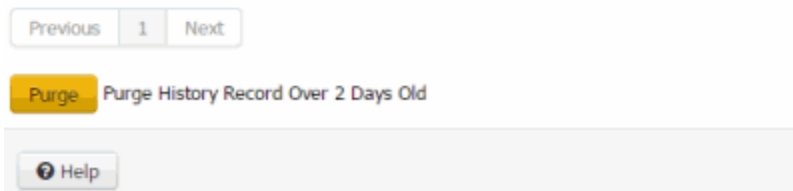

File Number: Unique code that the system assigned to identify the account.

Name: Name of the customer associated to the account.

Date: Date and time a user last viewed or worked the account.

3. In the **File Number** column, click the account. The following outcomes are possible:
 - If your organization requires you to validate information with the caller before displaying the account, the **Data Protection** dialog box appears. Verify the information with the caller and then click **Validated**. If you click **Not Validated**, the system doesn't display the account.
 - If there are warnings for the account, the **Warnings** dialog box appears. Review the warnings and then click **OK**.
 - The account displays.

Purge Account History

Use the **Account History** panel to delete accounts from account history that have been in account history for more than two days. The purge process doesn't delete the accounts from the system.

To purge account history

1. If the **Search & Queue Selection** panel isn't visible, click the Search slide-in icon. The **Search & Queue Selection** panel appears.
2. In the menu bar, click **Account History**. The **Account History** panel appears.

Account History

File Number	Name	Date
1004	ZELLERS Jr, LESLIE E	1/30/15 8:20 am
1035	SAURO, LISA	1/30/15 7:38 am
1033	VALORE, ANTHONY J	1/30/15 7:30 am

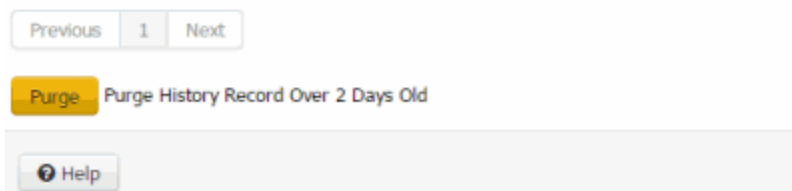

3. Click **Purge**.

Select an Account from Inventory

Use the **Inventory** panel to view accounts assigned to you and then select an account to display.

To select an account from inventory

1. If the **Search & Queue Selection** panel isn't visible, click the Search slide-in icon. The **Search & Queue Selection** panel appears.

- In the menu bar, click **Inventory**. The **Inventory** panel appears.

Inventory

All Status Codes ▾

File Number	Queue Date	Name	Client	Received	Balance	Status
1000	10/30/14	KILE, RICHARD	0000001	2/11/11	\$967.47	NEW
1002	10/30/14	BURGOYNE, EILEEN A	0000001	2/11/11	\$819.47	NEW
1006	10/30/14	DAVIS, WILLIE	0000001	2/11/11	\$167.73	NEW
1007	10/30/14	FRY, BRAD	0000001	2/11/11	\$596.03	NEW
1008	10/30/14	FUSI, SUSAN M	0000001	2/11/11	\$476.55	NEW
1009	10/30/14	HILL, SHERYL	0000001	2/11/11	\$596.60	NEW
1010	10/30/14	HILL, SHERYL	0000001	2/11/11	\$965.55	NEW
1011	10/30/14	SMITH, GINA	0000001	2/11/11	\$908.56	NEW
1013	10/30/14	THOMPSON, PAMALA	0000001	2/11/11	\$25,000.00	NEW
1014	10/30/14	ELLERBE, STACY	0000001	2/11/11	\$1,323.53	NEW

Previous 1 2 3 4 5 6 7 8 9 10 Next

Help

Filter: Account status for which to display accounts. If you select **All Status Codes**, all accounts assigned to you display, regardless of account status.

File Number: Unique code that the system assigned to identify the account.

Queue Date: Date the system or a user assigned the account to the queue.

Name: Name of the customer associated to the account.

Client: Number that identifies the client associated to the account.

Received: Date your organization received the account.

Balance: Account balance.

Status: Status of the account.

- In the **Filter** list box, click a status code for which to display accounts.
- In the **File Number** column, click the account. The following outcomes are possible:
 - If your organization requires you to validate information with the caller before displaying the account, the **Data Protection** dialog box appears. Verify the information with the caller and then click **Validated**. If you click **Not Validated**, the system doesn't display the account.
 - If there are warnings for the account, the **Warnings** dialog box appears. Review the warnings and then click **OK**.
 - The account displays.

Latitude Integration with PureConnect

PureConnect Dialer Agent Interface

The **PureConnect Dialer Agent Interface** adds PureConnect's Interaction Dialer capabilities to Latitude, including automated dialing and manual calling.

Important!



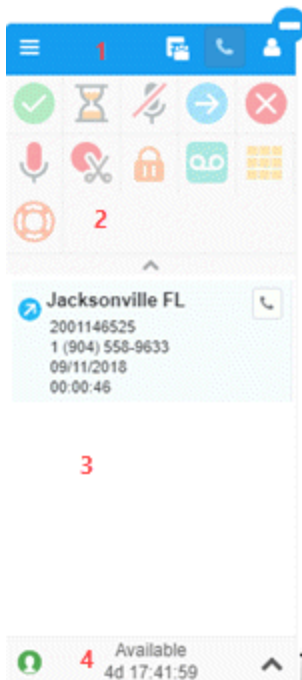

This feature is available to Latitude clients who also have Customer Interaction Center, which is a Genesys product on the PureConnect platform. For more information, see [Customer interaction Center](#) in the [PureConnect Documentation Library](#).

The interface includes the following features:

- Single sign-on to Interaction Dialer.
- Inbound call account pop based on ANI lookup.
- End a call and then disposition it. User cannot receive the next call until after dispositioning the current call.
- Transfer a call to another user.
- Conference in a third party.
- Request a break. Agent cannot receive calls until indicating that the break ended.



1. **Dialer Agent Interface toolbar:** Displays options for the **Dialer Agent Interface**.

Icon	Name	Description
	Hamburger menu	Displays a list of options for the Dialer Agent Interface , such as viewing interactions or logging on to or off of campaigns.
	Workgroup Queues icon	Opens the CRM web Client window to allow you to view your workgroup queues.
	Phone icon	Feature not available.
	User icon	Displays a list of user options, such as changing your station or logging out of the Dialer Agent Interface .

2. **Dialer toolbar:** Displays the actions available for the current campaign call. For more information about the icons, see [PureConnect Dialer Agent Interface Icons](#).
3. **Information:** Displays information about the current campaign call and other notifications.
4. **Status bar:** Displays your current status and available options such as the option to request a break. For more information about user statuses, see [Dialer User Statuses \(PureConnect\)](#).

Log on to PureConnect Dialer Agent Interface

Use the **Logon** pages to log on to the **PureConnect Dialer Agent Interface**. Your organization must have configured the Dialer permission.

Note: The pages that appear depend on how your organization set up the Dialer permission and your user account. If your system administrator specified a server in the Dialer permission, the **Select Server** page doesn't appear. If your system administrator added your Dialer credentials to your user account profile, the **Authentication** page doesn't appear.

To log on to the PureConnect Dialer Agent Interface

1. Locate the **PureConnect Dialer Agent Interface** on the Latitude Agent Desktop.

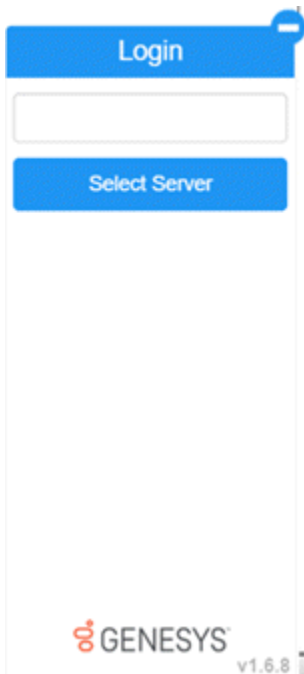

2. In the **Server** box, if the Interaction Dialer server name doesn't appear, type the name of the Interaction Dialer server and then click **Select Server**. The **Authentication** page appears.

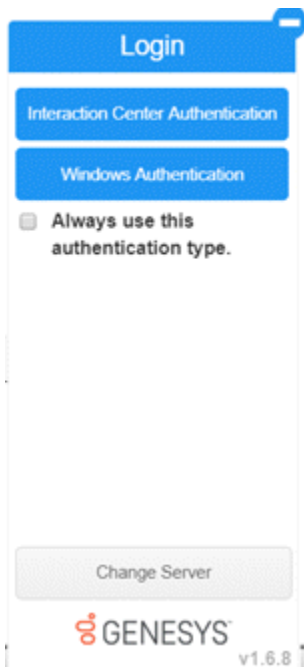

3. To use the same logon authentication each time you log on to Interaction Dialer, select **Always use this authentication type**.
4. Do one of the following:
 - To log on using your Latitude credentials, do the following:
 - a. Click **Interaction Center Authentication**.

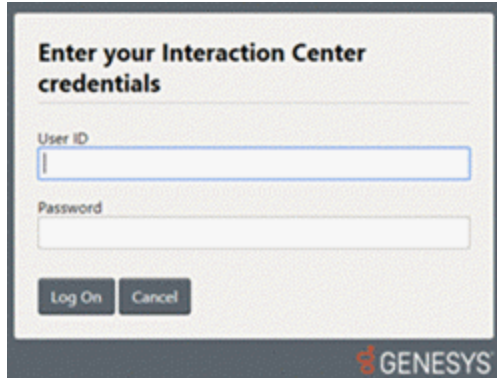

- b. Type your credentials in the boxes and then click **Log On**.
- To log on using your Windows credentials, do the following:
 - a. Click **Windows Authentication**.

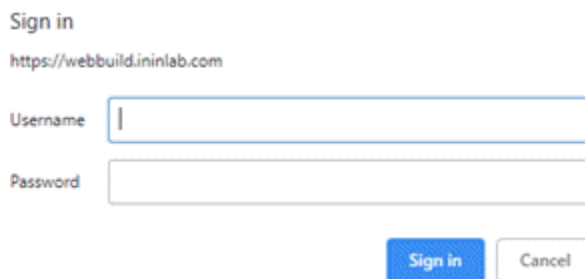

- b. Type your Windows credentials in the boxes and then click **Sign in**.

If your credentials are correct, the **Select Station** page appears. Otherwise, an error message appears; provide the correct credentials or contact your system administrator for assistance.

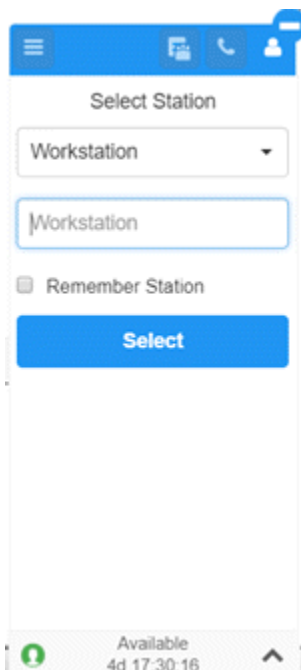

- 5. In the **Select Station** list box, click the type of station through which to receive calls.

6. Do one of the following:

- If you selected **Workstation**, in the **Workstation** box, type the name of the workstation to use.
- If you selected **Remote Workstation**, in the **Remote Workstation** box, type the name of the remote workstation to use. In the **Remote Number** box, type the remote telephone number to use.
- If you selected **Remote Number**, in the **Remote Number** box, type the remote telephone number to use.

For more information about stations, see "Overview of stations" in the *Interaction Administrator* documentation.

7. To use the same station each time you log on to the **PureConnect Dialer Agent Interface**, select **Remember Station**.
8. Click **Select**. Latitude logs you on to the **PureConnect Dialer Agent Interface** with a status of Available.



Tip: To minimize the **PureConnect Dialer Agent Interface**, click the minus sign (-). The system minimizes the **PureConnect Dialer Agent Interface** and displays the Dialer icon.

Set Your Workgroup Status (PureConnect)

Use the **Workgroup Activation** page to set your workgroup status to active so that you can receive ACD workgroup calls.

To set your workgroup status

1. In the **PureConnect Dialer Agent Interface** toolbar, click the Hamburger menu and then click **Workgroup Activation**.

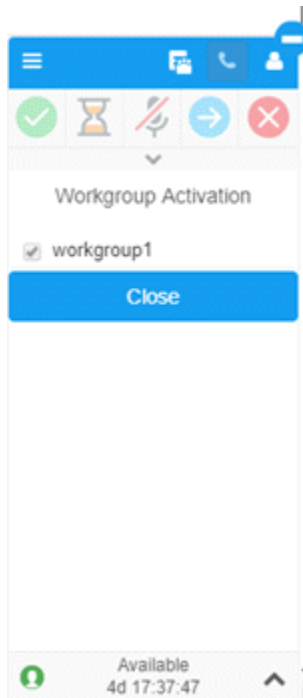

2. If the check box for your workgroup is cleared, select it.

Interaction Dialer Campaigns











Interaction Dialer Campaigns

Your organization creates campaigns and assigns users to them to manage calling efforts. Each campaign contains a list of phone numbers to dial. Depending on the calling mode set for the campaign, Interaction Dialer places the call for you (Power or Predictive mode) or you place the call manually (Preview mode). Latitude searches for the party and displays the matching account. For multiple matches, Latitude displays the list of matching accounts and then you select the appropriate account to display.

PureConnect Dialer Agent Interface Icons

The following table lists the icons available in the **PureConnect Dialer Agent Interface** toolbar. If an option is unavailable, the icon is dim instead of brightly colored. If an icon has a blue underline, it is selected currently.

Icon	Name	Description
	Dial Pad icon	<p>Opens the dial pad while you are on a call to allow you to:</p> <ul style="list-style-type: none"> • Send DTMF (Dual-Tone Multi-Frequency) tones to the connected call • Select IVR options

		<ul style="list-style-type: none"> Provide information such as an account number or credit card number
	Dialer Agent Interface icon	Represents the minimized state of the PureConnect Dialer Agent Interface . To maximize the interface, click the icon.
	Disconnect icon	Disconnects or skips the call.
	Hold icon	Places the call on hold. To resume the call, click the icon again.
	Mute icon	Mutes the call. To unmute the call, click the icon again.
	Place This Call icon	Places a call to the number in the campaign list.
	Record icon	Records the call and saves it as a WAV file. To stop recording, click the icon again.
	Request Assistance icon	Opens the Request Assistance dialog box to allow you to request assistance from a supervisor.
	Secure Plus icon	Starts a separate, secure session to allow the customer to provide confidential information (such as credit card data) so that you cannot see or hear it.
	Snippet icon	Feature not available in the Latitude integration to Interaction Dialer.
	Transfer icon	Opens the Transfer dialog box to allow you to transfer the call to another user, workgroup, or outside phone number.
	Voicemail icon	Sends an incoming or connected call to your voicemail.

Log on to a Campaign (PureConnect)

Use the **Campaigns** page to log on to one or more campaigns.

To log on to a campaign

1. In the **PureConnect Dialer Agent Interface** toolbar, click the Hamburger menu and then click **Campaigns**.

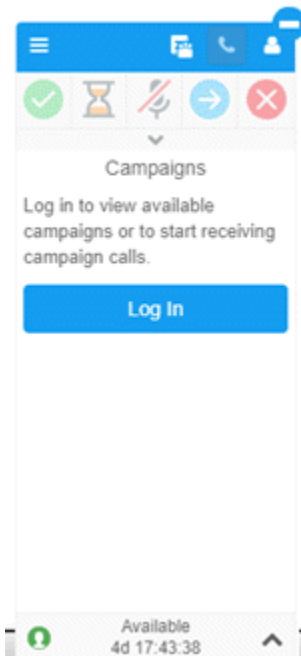

2. Click **Log in**. The system logs you on to Interaction Dialer and displays the available campaigns.

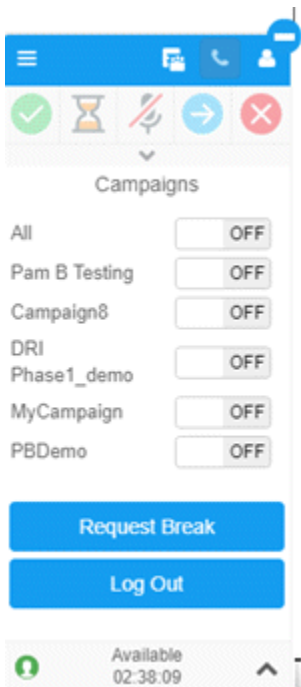

3. Use the slider to turn on all campaigns or just specific ones.
4. In the **PureConnect Dialer Agent Interface** toolbar, click the Hamburger menu and then click **Interactions**. The specified campaign opens and the first interaction appears.

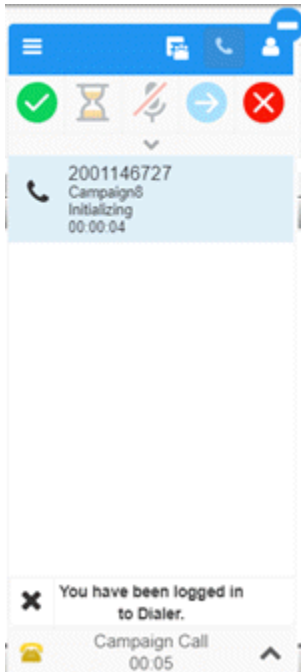

5. Do one of the following:
 - If the campaign calling mode is Power or Predictive, see [Work a Power or Predictive Campaign \(PureConnect\)](#).
 - If the campaign calling mode is Preview, see [Work a Preview Campaign \(PureConnect\)](#).

Work a Power or Predictive Campaign (PureConnect)

Use the **Dialer Agent Interface** to work a Power or Predictive campaign. When the campaign calling mode is Power or Predictive, the following occurs:

1. Dialer displays a campaign list phone number in the **PureConnect Dialer Agent Interface**.
2. Dialer places the call and delivers the call to you.
3. Latitude looks up the account based on the phone number and does one of the following:
 - If only one account has a matching phone number, Latitude displays the account.
 - If more than one account has a matching phone number, Latitude displays the list of matching accounts. Click the account to display. Latitude closes the list and displays the selected account.

Latitude Printable Help

Carlton Martin
File #: 1440
Status: NEW
Q-Level: 015
Q-Date: 9/14/18
Branch: 00000
Desk: C1
Charge Off Amount:
Interest Since Charge Off:
Last Worked:
Last Contacted:
Last Payment:
Total Paid: \$0.00
Current Balance:
Carlton Martin
1227R
0000008 - SECOND CUSTOMER
Last Paid \$0.00 on
NEW
Cycles: (9)
\$50.00 Monthly
Due on 1/1/00
0 Broken Promises
0 Declined CC
0 Returned Checks
Total \$350.00
Past Due \$300.00
Aging
Amount \$50.00 \$50.00 \$50.00 \$50.00 \$50.00 \$50.00 \$50.00
Times Delinquent 0 0 0 0 0 0 0

Balance Details Major Dates Additional Information Contact Analysis Client Guidelines

Arrangements
Care and Financial Hardship
Complaints
Customer
Disputes
Legal - New Court Case
Letters
Payments

Payment Negotiator
Method: Select a payment
Start Date: 9/18/2018
Amount: \$ 350
First Amount: \$
Frequency: Monthly Day 18
Surcharge Amount: \$0.00
Payments: Will be calculated OFF
Total: \$350.00
Surcharge Total: Will be calculated
Gross Total: Will be calculated
Negotiated: \$250.00

DB Server Name: LT008DEVHYD.qJun.com[SQL2012DEV|Database: Collect2000|Previous Login: Sep 18, 2018 8:52:20 am|Time on Account: 00:03:52|Follow Up 03:07

4. During or immediately after ending the call, disposition it. For more information, see [Disposition a Call \(PureConnect\)](#).

Work a Preview Campaign (PureConnect)

Use the **Dialer Agent Interface** to work a Preview campaign. When the campaign calling mode is Preview, the following occurs:

1. Dialer displays a campaign list phone number in the **PureConnect Dialer Agent Interface**.
2. Dialer does not place the call.
3. Latitude looks up the account based on the phone number and does one of the following:
 - If only one account has a matching phone number, Latitude displays the account.
 - If more than one account has a matching phone number, Latitude displays the list of matching accounts. Click the account to display. Latitude closes the list and displays the selected account.

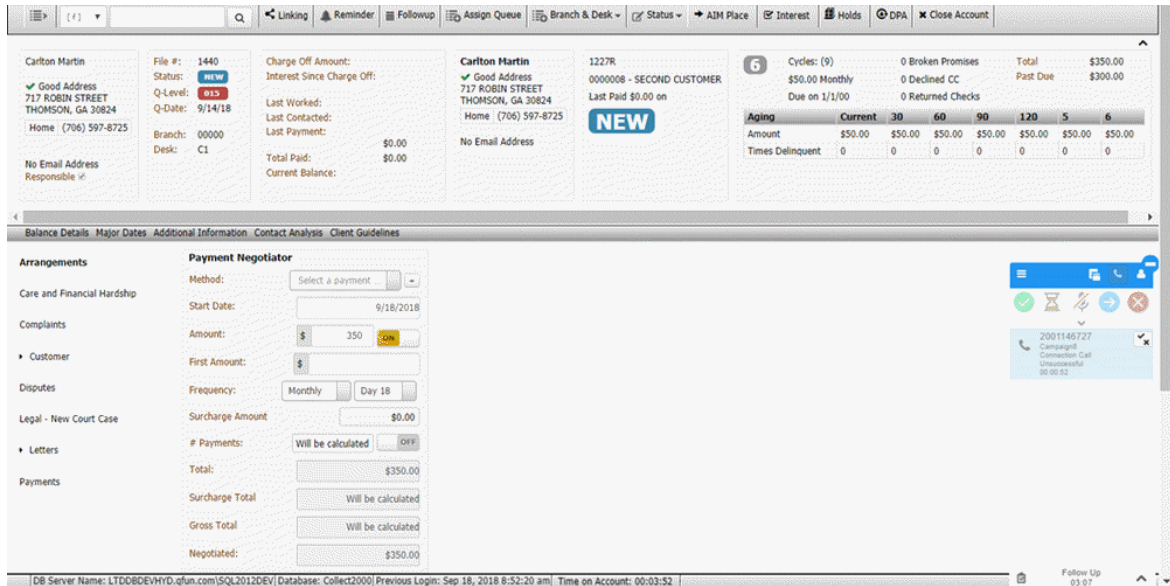

4. Do one of the following:
 - To place the call, in the Dialer toolbar, click the "Place this call" icon. Dialer places the call.
 - To skip to the next number in the campaign list, in the Dialer toolbar, click the "Skip this call" icon. Dialer displays the next account in the campaign list.
5. During or immediately after ending the call, disposition it. For more information, see [Disposition a Call \(PureConnect\)](#).

Disposition a Call (PureConnect)

Use the **Disposition** dialog box to disposition a call. You can specify a disposition while on the call or immediately after ending the call. You won't receive more calls until you disposition the current call.

To disposition a call

1. Click the Disposition icon .

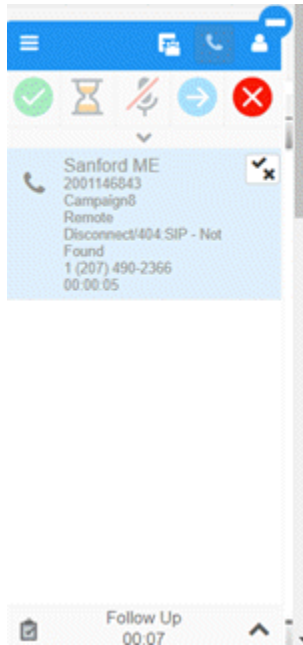

The **Disposition** dialog box appears.

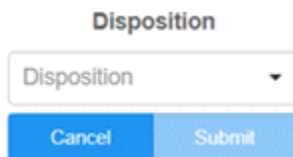

2. In the **Disposition** list box, click the disposition to assign to the call and then click **Submit**. Latitude adds a note to the **Notes** panel.

Request a Break (PureConnect)

Use the **Request Break** option to request a break to stop receiving campaign calls.

To request a break

- Do one of the following:
 - In the **PureConnect Dialer Agent Interface** toolbar, click the User icon and then click **Request Break**.
 - In the Status bar, click the arrow and then click **Request Break**.
 - In the **PureConnect Dialer Agent Interface** toolbar, click the Hamburger menu, click **Campaigns**, and then click **Request Break**.

You won't receive more calls until you end your break.

End Your Break (PureConnect)

Use the **End Break** option to end your break so that you can begin receiving calls again.

To end your break

- Do one of the following:

- In the **PureConnect Dialer Agent Interface** toolbar, click the User icon and then click **End Break**.
- In the Status bar, click the arrow and then click **End Break**.
- In the **PureConnect Dialer Agent Interface** toolbar, click the Hamburger menu, click **Campaigns**, and then click **End Break**.

You are now available to receive calls.

Request Assistance with a Call (PureConnect)

Use the **Request Assistance** dialog box to request assistance with a call.

To request assistance with a call

1. In the **PureConnect Dialer Agent Interface** toolbar, click the Request Assistance icon.

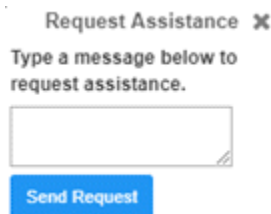

Request Assistance ✕

Type a message below to request assistance.

Send Request

2. In the box, type a message to send regarding your request for assistance and then click **Send Request**. A supervisor receives your request for assistance.
3. To view the request, in the **PureConnect Dialer Agent Interface** toolbar, click the Workgroups icon. The **CRM Web Client** window appears.
4. Click the **My Interactions** tab.

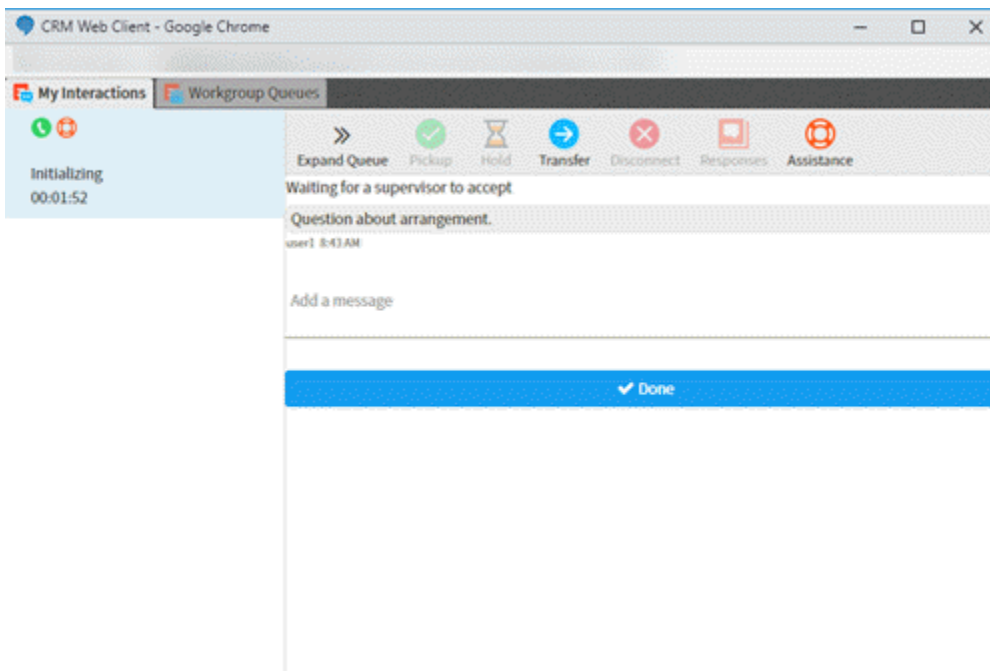

Transfer a Call (PureConnect)

Use the **Transfer** dialog box to transfer a call to another user, workgroup, or outside phone number.

To transfer a call

1. In the **PureConnect Dialer Agent Interface** toolbar, click the Transfer icon.

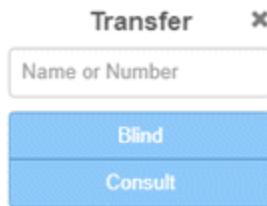

2. In the box, type the name of a user or workgroup, a user's phone number, or an outside party's phone number. As you type a user or workgroup name, matches from your Directory appear, along with the status. For example, a Phone icon indicates that the user is on a call.
3. Do one of the following:
 - To transfer the call without speaking to the recipient first, click **Blind**. Dialer connects the recipient to the call and disconnects you from the call.
 - To speak to the recipient before transferring the call, do the following:
 - a. Click **Consult**. Dialer places the call that you are transferring on hold.
 - b. Do one of the following:
 - If the recipient answers and agrees to the transfer, click the Transfer icon again and then click **Complete**. Dialer connects the recipient to the call and disconnects you from the call.
 - If the recipient doesn't answer or doesn't agree to the transfer, click **Disconnect**. Dialer disconnects the call to the recipient and takes the original call off hold.

View Your Campaign Interactions (PureConnect)

Use the **Interactions** page to view your campaign interactions. Icons and other indicators show the status of the call, such as connected or on hold. Use the active icons in the **PureConnect Dialer Agent Interface** toolbar to act on an interaction, such as place or disconnect a call.

To view your campaign interactions

- In the **PureConnect Dialer Agent Interface** toolbar, click the Hamburger menu and then click **Interactions**.



Log off a Campaign (PureConnect)

Use the **Campaigns** page to log off a campaign.

To log off a campaign

1. In the **PureConnect Dialer Agent Interface** toolbar, click the Hamburger menu and then click **Campaigns**.

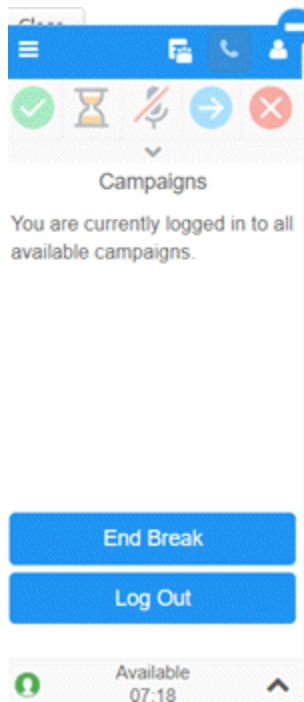

2. Click **Logout**. The system logs you off the campaign.

Dialer User Statuses (PureConnect)

Dialer User Statuses (PureConnect)

The **PureConnect Dialer Agent Interface** includes a list of statuses from which you can choose to indicate your availability to receive campaign calls. Your ability to receive calls depends on your status. For more information about possible available statuses, see [Possible Status Values](#) in the [Interaction Client Help](#).

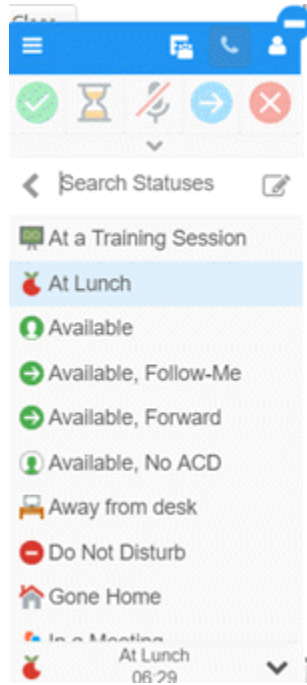

Search Statuses: Allows you to search for a specific status.

Edit Status icon: Allows you to specify a note regarding your current status.

Available Statuses list: Statuses that are available to select.

Status bar: Displays your current status and the amount of time that you've been in that status.

Change Your Dialer Status (PureConnect)

Use the **Status** page to change your status in the **PureConnect Dialer Agent Interface**.

Note: If you are logged on to a campaign, you cannot change your status until you request a break. For more information, see [Request a Break \(PureConnect\)](#).

To change your Dialer status

1. On the status bar of the **PureConnect Dialer Agent Interface**, click the arrow next to your current status. A list of available statuses appears.

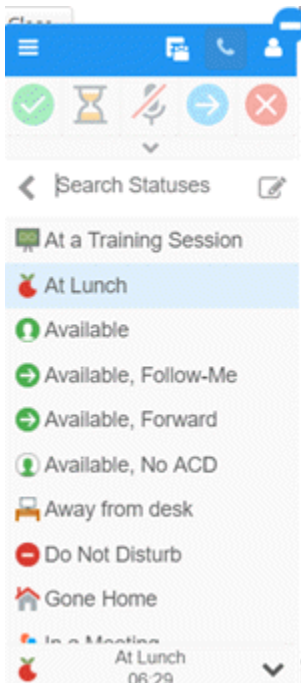

2. To search for a status, in the **Search Statuses** box, begin typing the status for which to search. Statuses that match your search criteria appear.

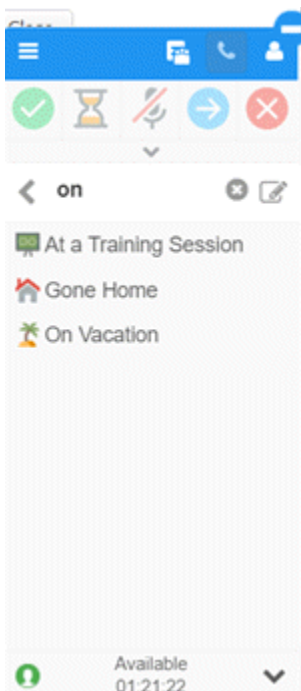

For more information about possible available statuses, see [Possible Status Values](#) in the [Interaction Client Help](#).

3. Click a status. If you changed your status to "Available, Forward", the **Status Notes** dialog box appears.

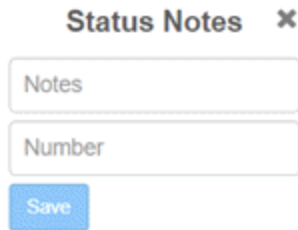

4. If the **Status Notes** dialog box appears, do the following:
 - a. In the **Notes** box, type a message regarding your status.
 - b. In the **Number** box, type your forwarding phone number and then click **Save**.

Your status changes and the status timer restarts.

Add a Note About Your Dialer Status (PureConnect)

Use the **Status Notes** dialog box to add a message regarding your current Dialer status.

Note: If you are logged on to a campaign, you cannot add a note about your status until you request a break. For more information, see [Request a Break \(PureConnect\)](#).

To add a note about your Dialer status

1. On the status bar of the **PureConnect Dialer Agent Interface**, click the arrow next to your current status. A list of available statuses appears.

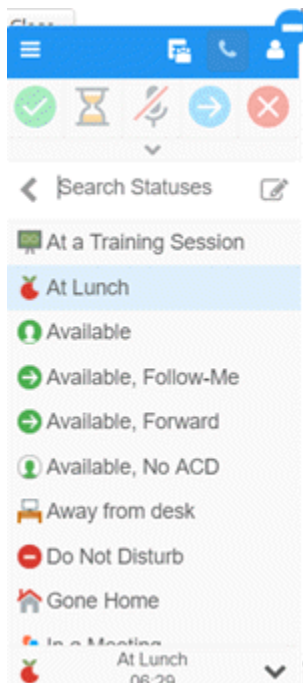

2. Next to the **Search Statuses** box, click the Edit icon. The **Status Notes** dialog box appears. The information that displays depends on your status.

3. In the **Notes** box, type a message regarding your status.
4. Specify the following data based on your status:

Status	Other Data to Provide
At a Training Session	Until Date: Date your status ends. Until Time: Time your status ends.
At Lunch	Until Time: Time your status ends.
Available, Follow Me	Until Date: Date your status ends.
Available, Forward	Number: Your forwarding phone number.
In a Meeting	Until Date: Date your status ends. Until Time: Time your status ends.
On Vacation	Until Date: Date your status ends.
Out of the Office	Until Date: Date your status ends. Until Time: Time your status ends.
Out of Town	Until Date: Date your status ends. Until Time: Time your status ends.

5. Click **Save**.

Note: Your status doesn't change automatically when this time ends. You must change your status manually.

6. To view the note, click the Hamburger menu and then click **Directory**. The **Directory** page appears, with your message and any other status data under your user ID.

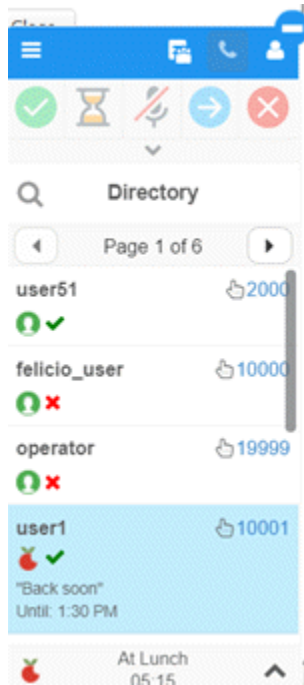

Modify or Remove a Dialer Status Note (PureConnect)

Use the **Status Notes** dialog box to modify or remove a message regarding your current status in the **PureConnect Dialer Agent Interface**.

Note: If you are logged on to a campaign, you cannot modify or remove a note about your status until you request a break. For more information, see [Request a Break \(PureConnect\)](#).

To modify or remove a note about your Dialer status

1. On the status bar of the **PureConnect Dialer Agent Interface**, click the arrow next to your current status. A list of available statuses appears.

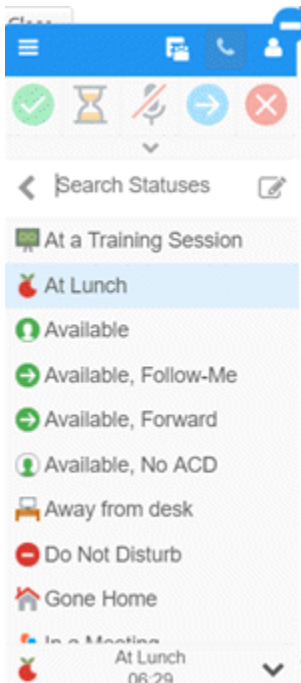

- Next to the **Search Statuses** box, click the Edit icon. The **Status Notes** dialog box appears.

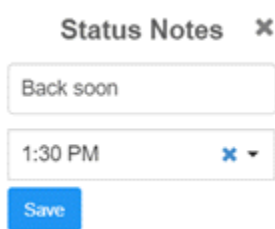

- In the **Notes** box, do one of the following:
 - To change your message, type a new message regarding your status.
 - To remove your message, delete the text.
- In the **Until Time** list box, do one of the following:
 - To change the end time, click the new end time for your status.
 - To delete the end time, click the **X**.
- Click **Save**.

View User Directory (PureConnect)

Use the **Directory** page to view a list of users who are logged on to Interaction Dialer.

To view the user directory

- In the **PureConnect Dialer Agent Interface** toolbar, click the Hamburger menu and then click **Directory**.

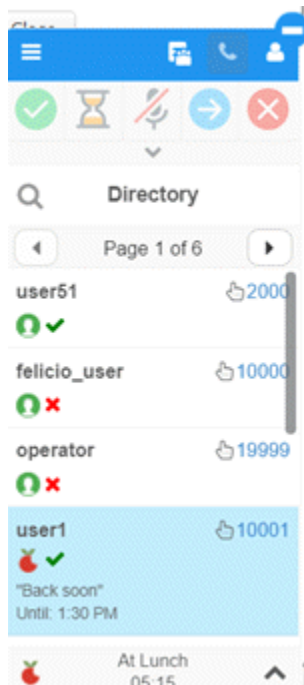

[User ID]: User name for the user logged on to Interaction Dialer.

[Phone Extension]: User's phone extension number.

[Current Status]: Icon that represents the user's current status in the **Dialer Agent Interface**. For example, the Apple icon indicates that the user is at lunch. For more information about these icons, see [Dialer User Statuses \(PureConnect\)](#).

[Logged on Status]: Icon that represents whether a user is logged on or off. A green check mark indicates that the user is logged on. A red X indicates that the user is logged off.

[Note]: Note the user added regarding the user's current status.

[Status End Time]: Time that the user indicated that the status will end. The system doesn't change the status automatically when the status time ends. Users must change their status manually.

2. To call a user's extension, click the user's extension number. The system dials the user's extension number.

Dialer Views (PureConnect)

Dialer Views (PureConnect)

Dialer provides options for the following:

- Viewing a list of users who are logged on to Interaction Dialer currently
- Viewing information about your recent incoming and outgoing calls
- Viewing information about your workgroup queues
- Viewing your open interactions

View a Workgroup Queue (PureConnect)

Use the **Workgroup Queues** tab in the **CRM Web Client** window to view information about your workgroup queues.

To view your workgroup queues

1. In the **PureConnect Dialer Agent Interface** toolbar, click the Workgroups icon. The **CRM Web Client** window appears.
2. Click the **Workgroup Queues** tab.

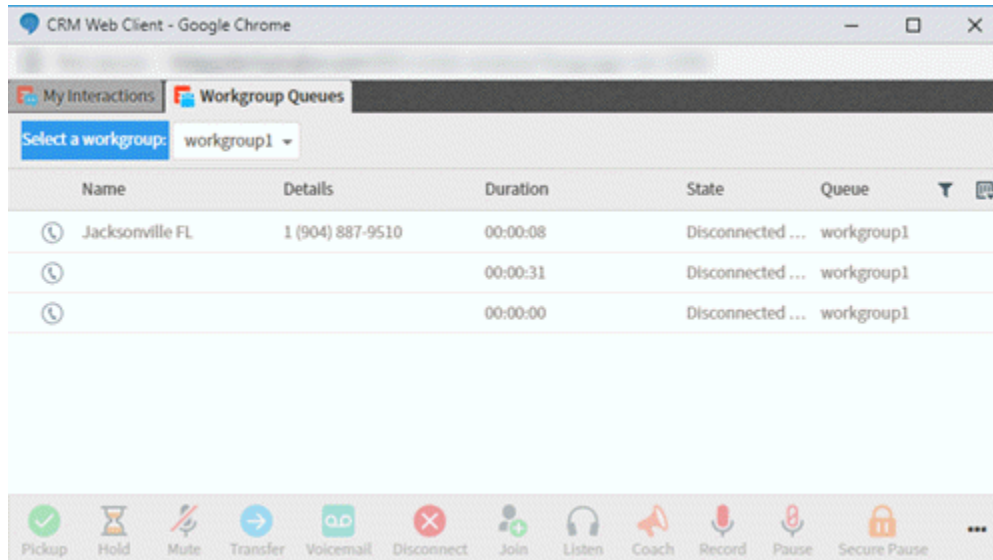

View Your Interactions (PureConnect)

Use the **My Interactions** tab in the **CRM Web Client** window to view your interactions, such as requests for assistance.

To view your interactions

1. In the **PureConnect Dialer Agent Interface** toolbar, click the Workgroups icon. The **CRM Web Client** window appears.
2. Click the **My Interactions** tab.

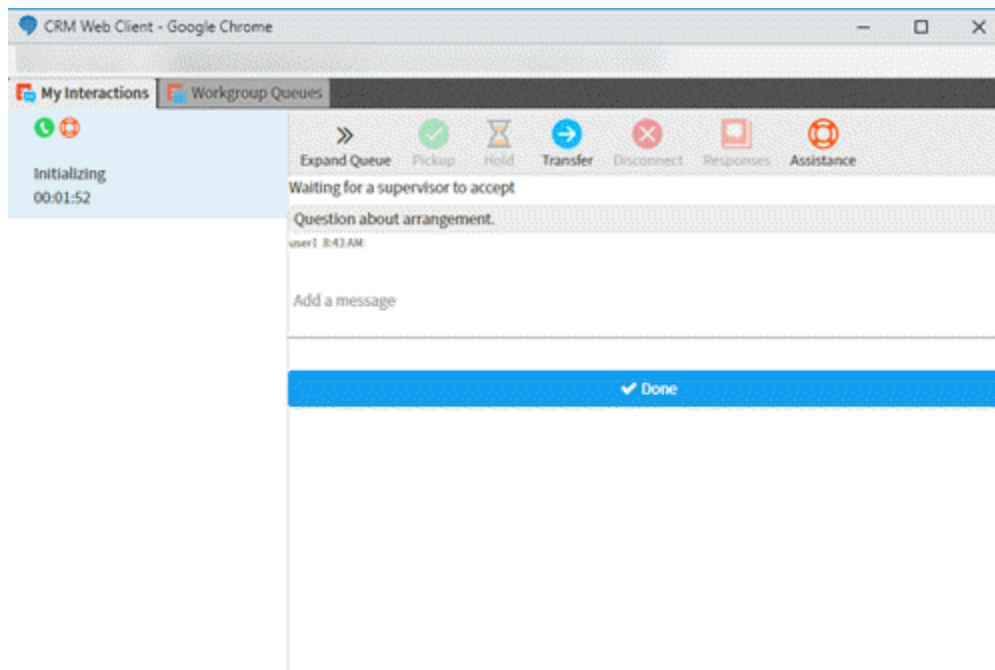

3. To close the request, click **Done**.

View Your Call History (PureConnect)

Use the **Call History** page to view your call history. You can view all your calls or just your missed, outgoing, answered, or forwarded calls.

To view your call history

- In the **PureConnect Dialer Agent Interface** toolbar, click the Hamburger menu and then click **Call History**.

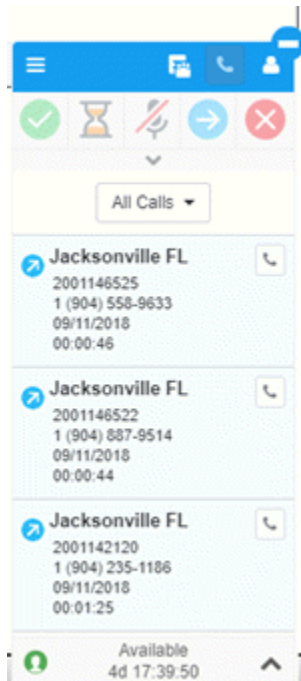

[Location]: City and state associated to the phone number.

[Account Code]: Interaction Administrator account code to associate to the phone call. If not available, your organization doesn't use this code.

[Phone Number]: Phone number that you called, answered, missed, or forwarded.

[Date]: Date the call occurred.

[Call Duration]: Duration of the call (from connection to disconnection or transfer), in hours, minutes, and seconds.

Place an Outbound Call (PureConnect)

Use the **Make a Call** dialog box to place an outbound call.

To place an outbound call

1. In the **PureConnect Dialer Agent Interface** toolbar, do one of the following:
 - Click the Phone icon.
 - Click the Hamburger menu and then click **Make a Call**.

The **Make a Call** dialog box appears.

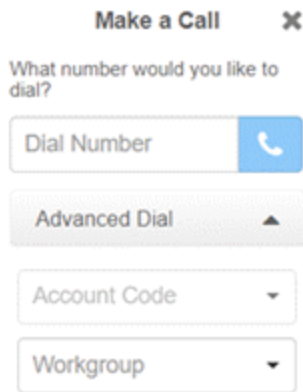

Dial Number: Phone number to dial.

Account Code: Interaction Administrator account code to associate to the phone call. If not available, your organization doesn't use this code.

Workgroup: Workgroup to associate to the phone call.

2. Complete the information and then click the Phone icon to place the call.

Change Your Station (PureConnect)

Use the **Select Station** page to change the station through which you receive calls.

To change your station

1. In the **PureConnect Dialer Agent Interface** toolbar, click the User icon.

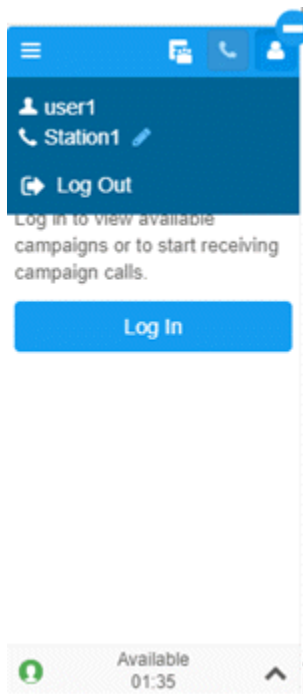

2. Click the Edit icon next to the station. The **Select Station** page appears.

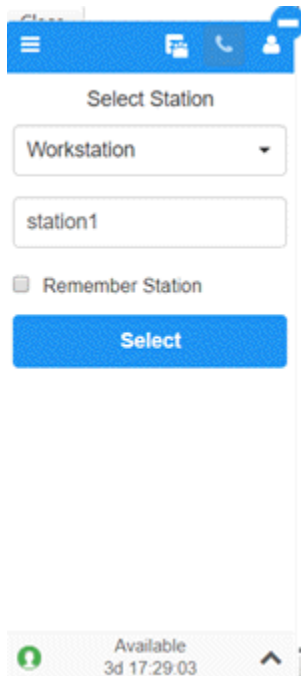

3. In the **Select Station** list box, click the type of station through which to receive calls.
4. Do one of the following:
 - If you selected **Workstation**, in the **Workstation** box, type the name of the workstation to use.
 - If you selected **Remote Workstation**, in the **Remote Workstation** box, type the name of the remote workstation to use. In the **Remote Number** box, type the remote telephone number to use.
 - If you selected **Remote Number**, in the **Remote Number** box, type the remote telephone number to use.

For more information about stations, see "Overview of stations" in the *Interaction Administrator* documentation.

5. To use the same station each time you log on to Interaction Dialer, select **Remember Station**.
6. Click **Select**.

Change Your Dialer Password (PureConnect)

Use the **Change Password** dialog box to change your Interaction Dialer password.

To change your Dialer password

1. In the **PureConnect Dialer Agent Interface** toolbar, click the Hamburger menu and then click **Change Password**.

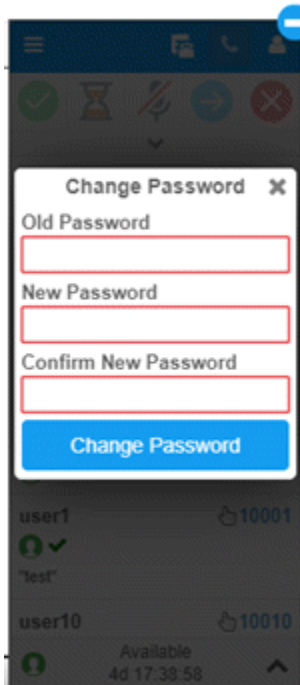

2. In the **Old Password** box, type your current Dialer password.
3. In the **New Password** box, type your new Dialer password.
4. In the **Confirm New Password** box, retype your new Dialer password.
5. Click **Change Password**.

Log off PureConnect Dialer Agent Interface

Use the **User** menu to log off the **PureConnect Dialer Agent Interface**. You must log off all campaigns before you can log off the **PureConnect Dialer Agent Interface**.

To log off the PureConnect Dialer Agent Interface

1. In the **PureConnect Dialer Agent Interface** toolbar, click the User icon.

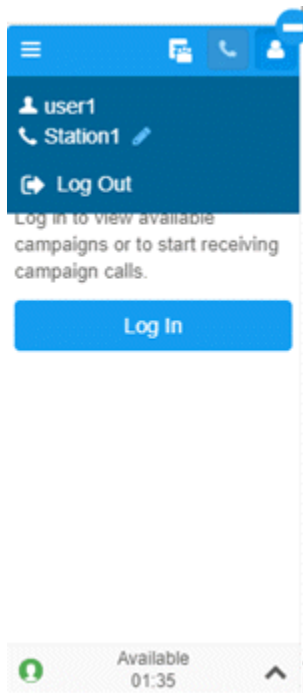

2. Click **Logout**. The system logs you out of the **PureConnect Dialer Agent Interface**.

Latitude Integration with Genesys Cloud

Latitude Integration with Genesys Cloud

The Latitude Integration with Genesys Cloud™ provides dialer capabilities inside Latitude through the Genesys Cloud client. This feature is available to Latitude clients who also have Genesys Cloud, a Genesys multi-tenant cloud solution. For more information about Genesys Cloud, see the [Genesys Cloud Resource Center](#).

Integration features

The integration provides:

- Comprehensive multi-site campaign management.
- Campaign monitoring and compliance. The best defense against regulatory violations and fines is an effective compliance plan. With U.S. and international sales and collections regulations tools, Genesys Cloud helps your business keep campaign compliance in check.
- Skills-based dialing based on user skill level.
- Inbound and outbound call blending.
- Stage-based predicting using Genesys' patented predictive algorithm to elevate user productivity and contact success rates.
- Real-time connectivity to third-party Do Not Call (DNC) services, such as DNC.COM (Contact Center Compliance), and in-house DNC lists, to help ensure regulatory compliance.
- Real-time removal of duplicate numbers from campaign call lists to assist with State and Federal call compliance guidelines.
- Unidirectional exchange of relevant statistics and data, such as call results and acquired payments.

Latitude configuration

Following are the Latitude configurations for the Latitude Integration with Genesys Cloud.

- **Access DialerConfig permission:** Allows access to the Latitude Dialer Integration Configuration program to configure the dialer integration. For more information, see Access Dialer Config Permission.
- **Access ListBuilder permission:** Allows access to the List Builder program to create call lists for dialer campaigns. For more information, see Access List Builder Permission.
- **Dialer permission:** Specify the settings for displaying the Genesys Cloud client on the Agent Desktop. This permission includes the ability to map Genesys Cloud wrap-up codes to Latitude results codes. For more information, see Dialer Permission and Map a Disposition Code to a Result Code.
- **Phone Type Mapping permission:** Map phone types to action codes. For more information, see Phone Type Mapping Permission.

- **Reference Panels permission:** Select to display the **Communication** panel to allow users to view all communications associated to an account. Users can view historical communication for an account, play audio recordings associated to an account, and view letters associated to an account. For more information, see Reference Panels Permission and [Communication](#).
- **Single-sign on (SSO):** Add a user's Genesys Cloud logon credentials to the user's Latitude account to allow Latitude to log the user on to the Genesys Cloud client without user intervention. For more information, see Add a User and Modify a User.

Other configurations

Other configurations include:

- **Browser**
 - Configure your browser to allow microphone use
- **Latitude Dialer Integration Configuration program**
 - Configure the Latitude database for dialer services
 - Configure real-time account removal
- **List Builder**
 - Configure the dialer server
 - Create and export call lists to create campaigns in Genesys Cloud
- **Genesys Cloud**
 - Create an OAuth client to allow Latitude APIs to communicate with the Genesys Cloud Platform API
 - Create an OAuth client to connect Genesys Cloud with your SSO service.
 - Configure Genesys Cloud for SSO.
 - Create and configure queues that serve as containers for interactions that are waiting for collectors assigned to the queue.
 - Create scripts that provide instructions to help collectors process interactions.

Important!

Calls won't connect unless you set the Microphone permission in your browser to **Allow**.

For more information about configuring the entire integration, see the [Latitude Integration with Genesys Cloud Installation and Configuration Guide](#) in the Latitude Documentation Library.

Genesys Cloud Client

The Genesys Cloud client adds Dialer capabilities to Latitude for Genesys Cloud™ users, including campaign and manual dialing. The options available are based on your permissions.

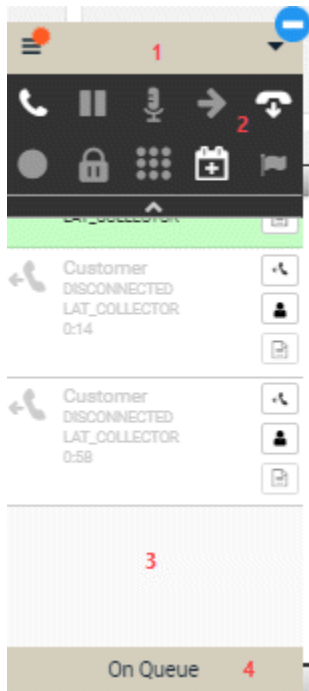

1. **Menu bar:** Provides access to two menus of options. For more information, see [Client interface in the Genesys Cloud embedded clients](#) in the Genesys Cloud Resource Center.

Hamburger menu options

Provides access to tasks, views, and settings. An orange burst indicates that your inbox contains new notifications.

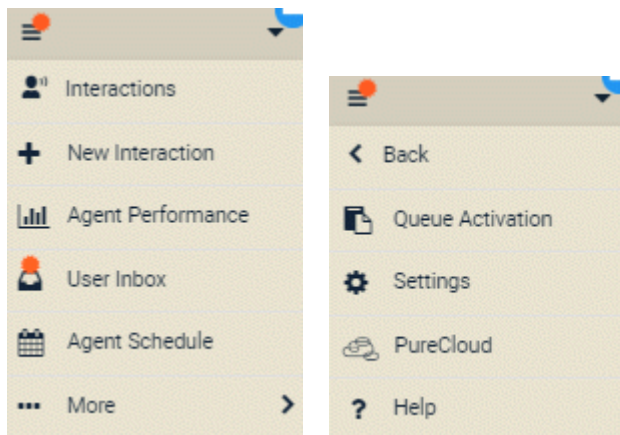

Option	Description
Interactions	View your active and recently disconnected interactions. For more information, see Interactions in the client menu in the Genesys Cloud Resource Center.

New Interaction	Place a call, send an email, or send an SMS message. For more information, see New Interaction in the client menu in the Genesys Cloud Resource Center.
Agent Performance	View your real-time statistics for voice, chat, email, and message interactions. For more information, see View agent performance statistics in the Genesys Cloud Resource Center.
User Inbox	View your call history, voicemails, evaluations, and work schedule notifications, such as shift trade and time off requests. For more information, see User Inbox in the client menu in the Genesys Cloud Resource Center.
Agent Schedule	View your work schedule (provided you have the appropriate permissions). For more information, see View your schedule in the Genesys Cloud Resource Center.
More	Display the next set of menu options.
Back	Display the previous set of menu options.
Queue Activation	<p>If you have the appropriate permissions in Genesys Cloud, you can view your active and available queues. Active queues are the queues that you receive interactions from when you go on queue. Available queues are the queues that you do not receive interactions from when you go on queue. You can move an active queue to the Available Queues list and you can move an available queue to the Active Queues list.</p> <p>For more information, see Queue activation in the Genesys Cloud Resource Center.</p>
Settings	View and configure your Genesys Cloud client settings, such as call forwarding and notifications. For more information, see Settings in the client menu in the Genesys Cloud Resource Center.

Genesys Cloud	Log on to Genesys Cloud, while remaining logged on to Latitude and the Genesys Cloud client. For more information, see Genesys Cloud in the client menu in the Genesys Cloud Resource Center.
Help	View the documentation for the Genesys Cloud client. Links to Help in the client menu in the Genesys Cloud Resource Center.

Arrow  menu options



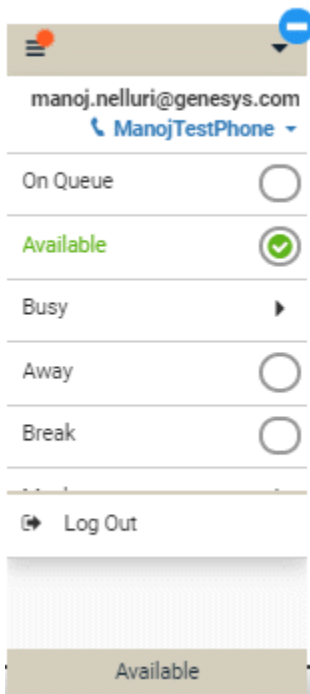



Allows you to change your status, change your phone, or log off the Genesys Cloud client.







Option	Description
Phone	Specify which phone to use when placing and receiving calls. For more information, see About phones in the Genesys Cloud embedded clients in the Genesys Cloud Resource Center.
Status	Change your primary (and in some cases, secondary) status. Your ability to receive interactions depends on your status. For more

	<p>information, see Statuses in the Genesys Cloud Resource Center.</p> <p>Important! To participate in a campaign, you must set your status to On Queue.</p>
Log Out	<p>Log off the Genesys Cloud client. For more information, see Log off Genesys Cloud Client.</p>

2. **Call Controls:** Displays the call controls that might be available, depending on your permissions and the interaction's current state. For more information, see [Call Controls](#) in the Genesys Cloud Resource Center.

Icon	Name	Description
	Pickup icon	Pick up an interaction.
	Hold icon	Place a call on hold.
	Mute icon	Mute a call.
	Transfer icon	Transfer an interaction.
	Disconnect icon	Disconnect an interaction.
	Record icon	<p>Record a call that you place manually through the interface or the Phones panel. Call recordings are available in the Communication panel in Latitude. For more information, see Play a Call Recording.</p> <p>Note: Call recording starts automatically in campaign dialing.</p>
	Secure Pause icon	<p>Pause a call recording. Secure pause prevents the recording of sensitive information, such as a credit card number.</p> <p>Note: Secure pause isn't available for calls that you place manually through</p>

		the interface or the Phones panel. However, if you used the Record icon to start recording the call, you can stop the recording and then restart it when ready.
	DTMF icon	Open the dialpad while on a call to allow you to send DTMF tones to the connected call, select IVR options, or type information such as an account number or credit card number.
	Schedule Callback icon	Display the Schedule a callback dialog box to allow you to schedule a callback for ACD voice interactions (call, callback, outbound dialing, and voicemail).
	Flag Voice Quality Issue icon	Flag voice interactions (call, callback, outbound dialing, and ACD voicemail) for quality issues such as deteriorated audio, unexpected disconnections, or failed transfers.

3. **Interactions:** Displays information about the current interaction, recent interactions, and other notifications. For more information, see [Interactions in the client menu](#) in the Genesys Cloud Resource Center.
4. **Status bar:** Displays your current status. When you click the Status bar, the same options appear as when you click the **Arrow**  menu.

Log on to Genesys Cloud Client

Use the **Logon** pages to log on to the Genesys Cloud client. To use the client, your organization must have configured the Dialer permission.

Note: The options that appear depend on how your organization set up the Dialer permission and your user account.

To log on to the Genesys Cloud client

1. Locate the Genesys Cloud client on the Latitude Agent Desktop.

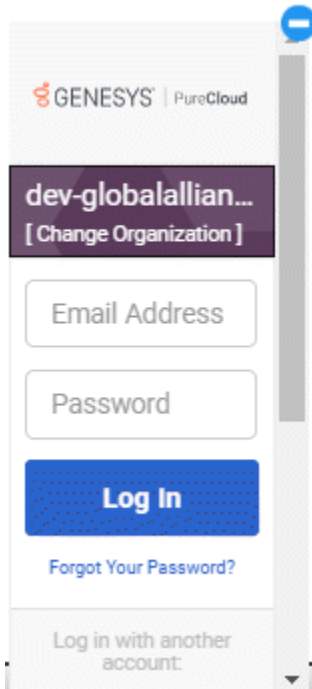

2. Do one of the following:

- If your Latitude account is not set up for single sign-on to the Genesys Cloud client, type your credentials in the **Email Address** and **Password** boxes and then click **Log In**.
- If your Latitude account is set up for single sign-on to the Genesys Cloud client, scroll down to the bottom of the interface and then click **Latitude by Genesys**.

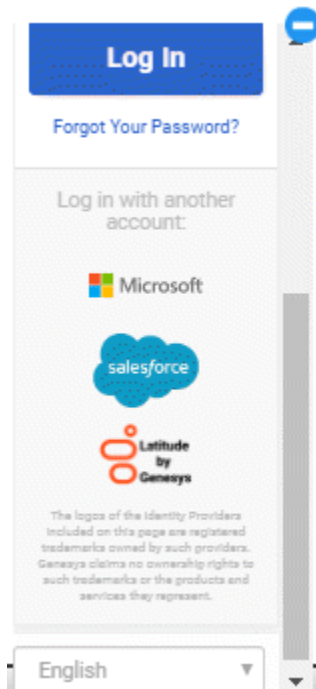

Latitude Printable Help

If your credentials are correct, Latitude logs you on to the Genesys Cloud client with a status of Available. Otherwise, an error message appears; provide the correct credentials or contact your system administrator for assistance.



Tip: To minimize the Genesys Cloud client, click the minus sign (-). The system minimizes the Genesys Cloud client and displays the Dialer icon .

Campaign Call Process

Your organization creates campaigns and assigns agents to them to manage calling efforts. Each campaign contains a list of phone numbers to dial, based on a call list that your organization created in List Builder. Depending on the calling mode set for the campaign, the dialer places the calls automatically (Power or Predictive mode) or the agent chooses to place or skip the calls (Preview mode). Either an agent or the system dispositions every outbound call to indicate what happened. For example, the dialer dispositions unsuccessful contact attempts (such as busy, no answer, and SIT) automatically.

Note: If you configured real-time account removal in the Latitude Dialer Integration Configuration program, Latitude removes from call lists phone numbers dialed once already on the current day. This feature assists agents in complying with Do Not Call lists, and rules that prohibit companies from calling the same person multiple times a day.

Power or Predictive campaign

A Power campaign waits to dial a number in the call list until an agent is available to receive the call. A Predictive campaign dials several numbers in the call list simultaneously before an agent becomes available to receive the call. When a live person answers, the dialer directs the call to an available agent.

1. The agent changes their current status to **On Queue** to indicate that the agent is available to receive interactions.

2. The dialer displays a phone number from the campaign list in the Genesys Cloud client and places the call.
3. Latitude displays the relevant account in the **Work Form**.
4. The agent picks up the call.
5. When the call ends, the agent disposes the call to classify it for reporting purposes.

Preview campaign

A Preview campaign allows an agent to view information about the party in the **Work Form** and then decide whether to place the call now or to skip it temporarily. Skipped calls remain in the queue.

1. The agent changes their current status to **On Queue** to indicate that the agent is available to receive interactions.
2. The dialer displays a phone number from the campaign list in the Genesys Cloud client but does not place the call.
3. Latitude displays the relevant account in the **Work Form**.
4. The agent does one of the following:
 - To place the call, the agent clicks the Pickup icon. The dialer places the call.
 - To skip the call, the agent clicks **Skip** in the Status bar. The dialer skips the call and displays the next number in the call list.
5. When the call ends, the agent disposes the call to classify it for reporting purposes.

Log off Genesys Cloud Client

Use the **Arrow**  menu or **Status** bar to log off the Genesys Cloud client.

To log off the Genesys Cloud client

Latitude Printable Help

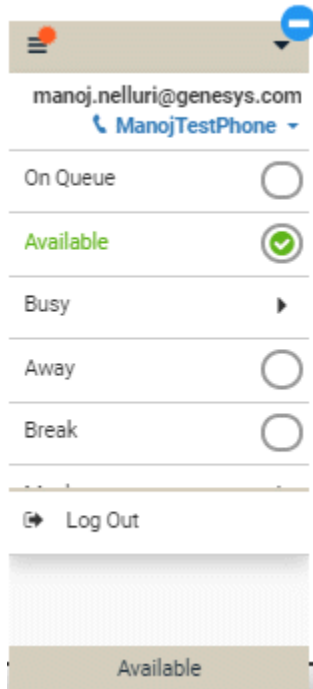

- Do one of the following:
 - Click the **Arrow** menu and then click **Log Out**.
 - Click the **Status** bar and then click **Log Out**.

The system logs you off the Genesys Cloud client.

Validate a Call

Use the **DPA Validation** dialog box to verify that you are speaking to the correct customer or authorized party before discussing the account. If your organization configured the system to require this validation, the system displays this dialog box automatically when you attempt to retrieve an account. You can also choose to display this dialog box at any time using the Account toolbar.

To validate a call

1. Do one of the following:
 - Retrieve an account using search, open interaction, work queue, history, or inventory.
 - In the **Account** toolbar, click **DPA**.

The **DPA Validation** dialog box appears.

DPA Validation

Client: 0000001 - CUSTOMER ONE Class of Business: 00000 - GENERAL CLASS OF BUSINESS
File #: 1000 Client Reference: 7738184767075
Status: NEW
Desk: 0000000 - ADMIN 1 DESK

Customer on Account: KILE, RICHARD
Name of Caller:
Address Line 1:
Post Code:
Date of Birth: Jan 15, 1945
Phone on Account:
Confirmed via Secondary Piece of Information
Client Requirements for DPA Validation

Account Warnings
DPA Outcome:
Continue Help

Client: Name of the client associated to the account.

File #: Unique code that the system assigned to identify the account.

Status: Three-character code that identifies the status of the account.

Desk: Desk assigned to the account.

Class of Business: Client's company type.

Client Reference: Unique code that the client assigned to identify the account.

Customer on Account: Name of the customer on the account.

Name of Caller: Name of the person on the phone.

Address Line 1: First line of the customer's address.

OK (Address Line 1): If selected, the address that the caller provided matches a value in the **Address Line 1** list box.

Post Code: Customer's postal code.

OK (Post Code): If selected, the postal code that the caller provided matches a value in the **Post Code** box.

Date of Birth: Customer's date of birth.

OK (Date of Birth): If selected, the postal code that the caller provided matches a value in the **Date of Birth** box.

Phone on Account: Phone number listed on the account.

OK (Phone on Account): If selected, the postal code that the caller provided matches a value in the **Phone on Account** list box.

Confirmed via Secondary Piece of Information: If selected, you confirmed the caller's information using resources other than Latitude.

Client Requirements for DPA Validation: Client requirements for data validation.

Account Warnings: Warning messages associated to the account.

DPA Outcome: Results of the validation. Valid values are:

Completed: Information the party provided is valid. The system displays the account.

RPC not made: (Right Party Contact). Party on the call is not the correct party. The system doesn't display the account.

Refused: Party on the call refused to verify the information. The system doesn't display the account.

Inconvenience: Party on the call indicated that it's not a convenient time to talk. The system doesn't display the account.

Failed: Information the party provided is not valid. The system doesn't display the account.

Bypass: You want to skip the validation process. The system displays the account.

Cancel: System cancels the validation process and doesn't display the account.

2. In the **Customer on Account** list box, click the customer on the account that the caller wants to discuss. The system populates the **Name of Caller** list box.
3. In the **Name of Caller** list box, click the name of the responsible party or authorized third party who is calling. The system populates the **Address Line 1**, **Postal Code**, **Date of Birth**, and **Phone on Account** boxes.
4. If the address that the caller provided is in the **Address Line 1** list box, click the address and then select the corresponding **OK** check box.
5. If the postal code that the caller provided matches the value in the **Post Code** box, select the corresponding **OK** check box.

6. If the date of birth that the caller provided matches the value in the **Date of Birth** box, select the corresponding **OK** check box.
7. If the phone number that the caller provided matches a value in the **Phone on Account** list box, click the phone number and then select the corresponding **OK** check box.
8. If you confirmed the caller's information using resources other than Latitude, select the **Confirmed via Secondary Piece of Information** check box.
9. If your organization configured client requirements for data validation, review the requirements in the **Client Requirements for DPA Validation** box.
10. In the **DPA Outcome** list box, click the results of the validation.
11. Click **Continue**. If you indicated that the information that the caller provided is valid, the account displays.

View Account Warnings

Use the **Warnings** dialog box to view warning messages for the account. You can click the **Warnings** link in the **Account** toolbar to open this dialog box at any time. For information about warnings displaying automatically, see the Warning Dialog Permission.

To view account warnings

1. In the **Account** toolbar, click **Warnings**.

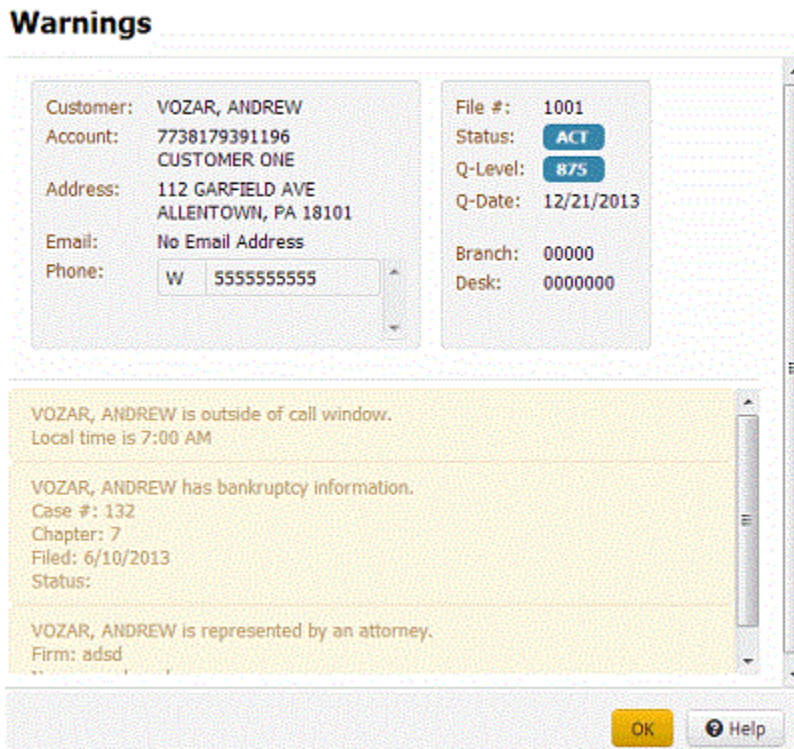

The screenshot shows a dialog box titled "Warnings". It is divided into two main sections. The top section contains account details in two columns. The left column lists: Customer: VOZAR, ANDREW; Account: 7738179391196 CUSTOMER ONE; Address: 112 GARFIELD AVE ALLENTOWN, PA 18101; Email: No Email Address; and Phone: W 5555555555. The right column lists: File #: 1001; Status: ACT (in a blue button); Q-Level: 875 (in a blue button); Q-Date: 12/21/2013; Branch: 00000; and Desk: 0000000. Below these sections is a scrollable area with three warning messages: "VOZAR, ANDREW is outside of call window. Local time is 7:00 AM", "VOZAR, ANDREW has bankruptcy information. Case #: 132, Chapter: 7, Filed: 6/10/2013, Status:", and "VOZAR, ANDREW is represented by an attorney. Firm: adsd". At the bottom right of the dialog box are "OK" and "Help" buttons.

Customer: Name of the customer on the account.

Since: Date the client opened the account.

Type: Type of account (for example, business or residential).

Account: Unique code that the client assigned to identify the account.

Address: Customer's street address, city, state, and postal code.

File #: Unique code that the system assigned to identify the account.

Status: Status of the account.

Q-Level: Three-digit code used to sort and prioritize accounts in the queue.

Q-Date: Date the system queues the account for the collector to work.

Branch: Customer branch associated to the account.

Desk: Desk assigned to the account.

Warnings: Warning messages for the account.

2. When finished viewing the information, click **OK**.

Display a Web Site on a New Browser Tab

If you have the Access Redirect Portal permission, you can display a web site that your organization specified in a new tab in your browser.

To display a web site on a new browser tab

- In the **Account** toolbar, click **Redirect to Portal**. The web site that your organization specified in the Access Redirect Portal permission displays on a new tab in your browser.

Delinquency or Recovery Anchor

Delinquency or Recovery Anchor

Latitude displays either a **Delinquency** or **Recovery** anchor, depending on which anchor your organization specified in the Anchor Permission. These anchors contain "cards" of information. The cards that display depend on which ones your organization assigned to the anchor, and the account displayed currently. For example, the system only displays the **Account Placement** card when an outside collection agency holds the account and when your organization includes it in the anchor card.

The following cards could display on an anchor, depending on your system configuration:

- [Account Labels Card](#)
- [Account Navigator Card](#)
- [Account State Card](#)
- [Account Status Card](#)
- [Account Summary Card](#)
- [AIM Card](#)
- [Charge-off Details Card](#)
- [Contact Card](#)
- [Delinquency Card](#)
- [First Party Active Collections Card](#)
- [Hot Notes Card](#)
- [Joined Accounts Card](#)
- [Link Summary Card](#)
- [Medical Account Details Card](#)
- [Party Card](#)
- [Party Navigator Card](#)
- [Pending Payments Card](#)
- [Support Queue Details Card](#)

Anchor Permission

Account Labels Card

Account Labels Card

The **Account Labels** card allows you to define labels for whatever purpose you choose and use them to flag accounts. For example, you can use the labels as tags, conditions, or properties. You can assign multiple labels to an account. Account labels appear on the **Account Labels** card in the **Delinquency** or **Recovery** anchor.

You must have the Labels - User Policy Permission to view labels, add labels to accounts, create labels, and delete labels from accounts.

Create a Label

Use the **Account Label** card in the **Delinquency** or **Recovery** anchor to create a label that you can use to flag accounts.

To create a label

1. Locate the **Account Label** card.

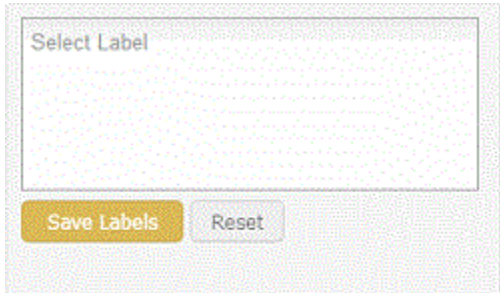

2. In the **Select Label** box, type a label name to indicate the purpose of the label. A link appears in the lower section of the card.

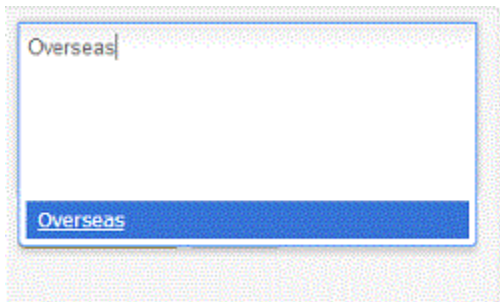

3. Press **Enter**. The system adds the label to the **Account Label** card.

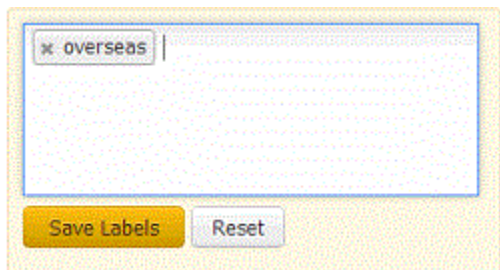

Tip: To cancel your changes, click **Reset**.

Add a Label to an Account

Use the **Account Label** card in the **Delinquency** or **Recovery** anchor to add an existing label to the account.

To add a label to an account

1. Locate the **Account Label** card.

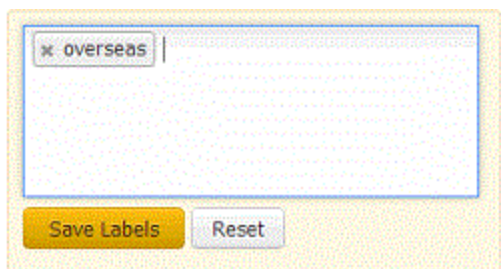

2. In the **Select Label** box, begin typing a label name.
3. Click the label name and press **Enter**. The system adds the label to the account.

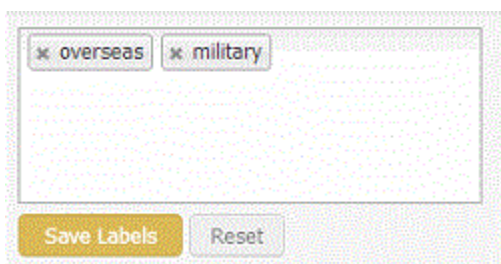

Tip: To cancel your changes, click **Reset**.

View Labels Associated to an Account

Use the **Account Label** card in the **Delinquency** or **Recovery** anchor to view the labels associated to the account.

To view labels associated to an account

- Locate the **Account Label** card.

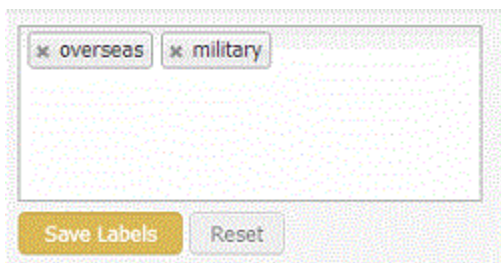

Delete a Label From an Account

Use the **Account Label** card in the **Delinquency** or **Recovery** anchor to delete a label from the account.

To delete a label from an account

1. Locate the **Account Label** card.

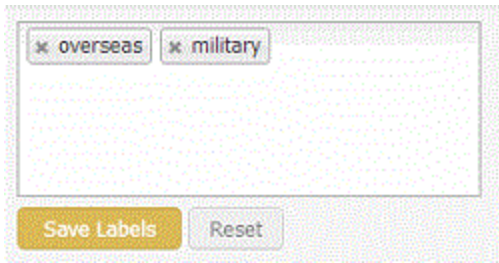

2. Click the **x** next to the label to delete.

Tip: To cancel your changes, click **Reset**.

Account Navigator Card

The **Account Navigator** card contains contact information for the parties on the account. The system displays each party on a separate tab within the card. The first tab displays the primary party on the account. Subsequent tabs display secondary parties on the account. Click a tab to display the account.



[Party]: Party's name. Click to view information for another party on the account.

[Address]: Party's street, city, state, and postal code.

[Email Address]: Party's email address.

Authorized for Customer: Customer who authorized this person to discuss the debt and pay on the account. This information appears when the **Is Responsible** check box is cleared.

If your organization placed a collection hold for a party on the account, a message displays in this card indicating that the customer is on hold.

Tip: To view the full contact name when it isn't visible, rest your mouse on the contact name.

Account State Card

The **Account State** card displays information regarding the state of the account.

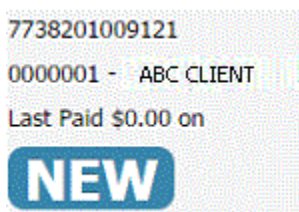

[Account Number]: Unique code that the client assigned to identify the account.

[Client]: Code that identifies the client, and the client's name. If the client's name exceeds 20 characters, you can rest your mouse on the name to see the full name.

[Status]: Status of the account. The status displays with a blue background for active accounts and a red background for closed accounts.

The card may also display the following information:

- Whether the account is residential or business.
- Last payment amount and date.
- Whether the system or a user canceled the account, and if so, the date and reason.

Account Status Card

The **Account Status** card displays the status information for the account.

File #:	1835
Status:	NEW
Q-Level:	015
Q-Date:	06/11/2014
Branch:	00000
Desk:	LIQUID

Tip: To see a description of the status; queue level; branch; or desk, rest your mouse on the data next to the label.

File Number: Unique code that the system assigned to identify the account.

Status: Status of the account. The status displays with a blue background for active accounts and a red background for closed accounts.

Q-Level: Queue level assigned to the account.

Q-Date: Date the account queued.

Branch: Agency branch assigned to the account.

Desk: Desk assigned to the account.

Note: If your organization placed a hold on the account, a message displays indicating that the account is on hold. To view the hold expiration date and reason, rest your mouse on the hold message.

Account Summary Card

The **Account Summary** card contains account information for the account.

Latitude Printable Help

Client:	000001 CUSTOMER ONE
Client Account Number:	98774586630012
Original Creditor:	PNC BANK
Date Last Paid Client:	
Charge Off Date:	
Received Date:	2/11/11
Net Original Balance:	\$250.00
Current Balance:	\$250.00
Last Payment:	\$0.00
Last Worked:	8/7/18
Last Contacted:	8/7/18

Client: Code that identifies the client, and the client's name. If the client's name exceeds 20 characters, you can rest your mouse on the name to see the full name.

Client Account Number: Unique code that the client assigned to identify the account.

Original Creditor: Original creditor assigned to the account. If the client's name exceeds 20 characters, you can rest your mouse on the name to see the full name.

Date Last Paid Client: Date the client last received a payment.

Charge Off Date: Date the client charged off the account.

Received Date: Date your organization received the account.

Net Original Balance: Original balance of each money bucket, plus or minus adjustments.

Current Balance: Current account balance.

Last Payment: Last payment amount that the client received.

Last Worked: Date a user last worked the account.

Last Contacted: Date a user last contacted a party on the account.

AIM Card

The **AIM** card displays information regarding the outside collection agency or attorney holding the account.

Placed Date:	9/25/14
Days Placed / Level:	0 / 1
Agency ID:	1
Agency Name:	Collections Plus Services
Agency Address:	123 Collections Road Suite 262 Jacksonville, Florida 32256
Agency Email:	
Agency Phone:	904-555-2900
Agency Fax:	904-555-2901

Placed Date: Date the client placed the account with the outside collection agency.

Days Placed / Level: Number of days the outside collection agency has had the account.

Agency ID: Unique code that identifies the outside collection agency.

Contact Information: Name, mailing address, email address, phone number, and fax number of the outside collection agency.

Charge-off Details Card

The **Charge-off Details** card displays charge-off information for the account.

Charge Off Amount:	\$500.00
Interest Since Charge Off:	\$0.00
Last Worked:	
Last Contacted:	
Last Payment:	10/21/14
	\$600.00
Total Paid:	(\$600.00)
Current Balance:	\$0.00
Credit Balance:	\$100.00

Charge Off Amount: Amount of the debt that the client charged off.

Interest Since Last Charge Off: Interest that accrued after the client charged off the debt.

Last Worked: Date a user last worked the account.

Last Contacted: Date a user last contacted a party on the account.

Last Payment: Date the client last received a payment.

Total Paid: Total amount paid.

Current Balance: Current account balance.

Credit Balance: Overpayment amount. If the customer didn't pay more than the account balance, the system doesn't display this information.

Contact Card

The **Contact** card contains contact information for the customer on the account.

Customer:	Henry Shreim
Since:	5/19/09 Residential
Account:	2267826447 POOL QUEUE CUSTOMER
Address:	✓ Good Address PO BOX 3572 SAN DIEGO, CA 92101
Email:	No Email Address
Phone:	No Phone

Customer: Customer's name.

Since: Date when the person became a customer and the type of account.

Account: Unique number that the client assigned to the account to identify it.

[Client Name]: Name of the client associated to the account. If the client name exceeds 20 characters, you can rest your mouse on the name to see the full name.

Address: Customer's address.

Email: Customer's email address.

Phone: Customer's telephone number.

Delinquency Card

The **Delinquency** card displays delinquency information for the account. The labels that appear in the data grid are based on how your organization configured the Delinquency Aging Bucket Labels Permission.

120	Cycles: (5)	0 Broken Promises	Total	\$250.00
	\$50.00 Monthly	0 Declined CC	Past Due	\$200.00
	Due on 1/1/1900	0 Returned Checks		

Aging	Current	30	60	90	120
Amount	\$50.00	\$50.00	\$50.00	\$50.00	\$50.00
Times Delinquent	0	0	0	0	0

[Account Age]: Age of the account. If the account is 30 days past due, the age displays with a yellow background. If the account is 60 days past due, the age displays with an orange background. If the account is 90 days or more past due, the age displays with a red background.

Cycles: Number of billing cycles.

[Billing]: Recurring billing amount and frequency.

Due on: Payment due date.

Broken Promises: Number of broken promises.

Declined CC: Number of declined credit card transactions.

Returned Checks: Number of returned checks.

Total: Total account balance.

Past Due: Total amount past due.

Amount: Amounts that are due currently or past due for each of the aging buckets.

Times Delinquent: Number of times the account was past due for each of the aging buckets.

First Party Active Collections Card

The **First Party Active Collections** card displays information regarding first-party active collections for the account.

# Accounts:	3	Current Balance:	\$3,217.47
Net Listed:	\$3,217.47	Postdates / Promises:	\$0.00
Interest Accrued:	\$0.00	Balance after Postdates:	\$3,217.47
Last Payment:	\$0.00	Next Postdate / Promise:	
Total Paid:	\$0.00	Final Postdate / Promise:	6/8/16

Portfolio	Account	Balance	Status
CUSTOMER ONE	7738184767075	\$967.47	ACT
CUSTOMER ONE	98774586630012	\$250.00	ACT
CUSTOMER ONE	74541021574653	\$2,000.00	ACT

Accounts: Number of accounts in the portfolio.

Net Listed: Net value of the accounts in the portfolio.

Interest Accrued: Interest accrued on the accounts in the portfolio.

Last Payment: Last payment amount on the accounts in the portfolio.

Total Paid: Total amount paid on the accounts in the portfolio.

Current Balance: Current balance of the accounts in the portfolio.

Postdates/Promises: Post-dated check and promise amounts for the accounts in the portfolio.

Balance After Postdates: Portfolio balance after subtracting post-dated checks.

Next Postdate/Promise: Next post-dated check or promise date.

Final Postdate/Promise: Final post-dated check or promise date.

Portfolio: Code that identifies the portfolio.

Account: Code that identifies an account in the portfolio.

Balance: Balance of the account.

Status: Status of the account.

Hot Notes Card

Hot Notes Card

The **Hot Notes** card allows you to add hot notes and standard notes to accounts.

Hot Notes

Hot notes display in the **Hot Notes** card and convey important information for working an account. The system retains the notes only until you clear the card. You can modify or delete hot notes that other users created.

Standard Notes

Standard notes display in the **Notes** panel. You use standard notes to track changes and save information about an account. The system retains the notes indefinitely. You cannot modify or delete standard notes.

Add a Hot Note to an Account

Use the **Hot Note** card in the **Delinquency** or **Recovery** anchor to add a hot note to the account.

To add a hot note to an account

1. Locate the **Hot Note** card.

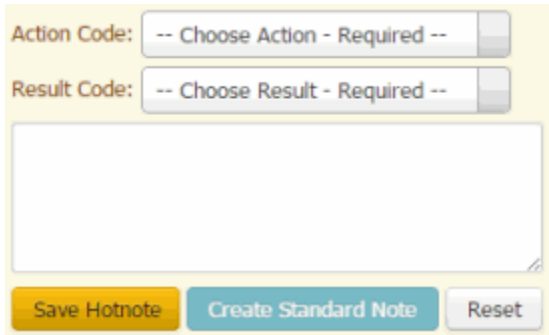

A screenshot of a web form for adding a hot note. It features two dropdown menus at the top: 'Action Code' and 'Result Code', both with the placeholder text '-- Choose Action - Required --' and '-- Choose Result - Required --' respectively. Below these is a large, empty text area for the note. At the bottom, there are three buttons: 'Save Hotnote' (yellow), 'Create Standard Note' (blue), and 'Reset' (grey).

2. In the **Action Code** list box, click the action on the account.
3. In the **Result Code** list box, click the result of the action.
4. In the **Note** box, type a note and then click **Save Hotnote**. The system adds the hot note to the account.

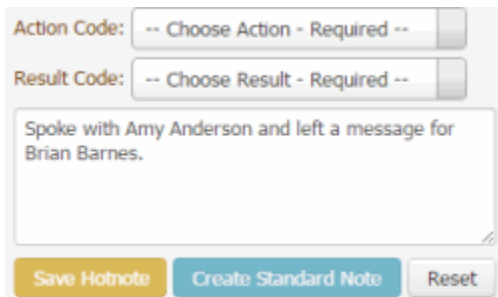

A screenshot of the same web form, but now with text entered in the note field. The text reads: 'Spoke with Amy Anderson and left a message for Brian Barnes.' The 'Action Code' and 'Result Code' dropdowns remain empty. The 'Save Hotnote' button is highlighted in yellow.

Tip: To cancel your changes, click **Reset**.

Add a Standard Note to an Account

Use the **Hot Note** card in the **Delinquency** or **Recovery** anchor to add a standard note to the account. You cannot modify or delete standard notes. For more information, see [Notes](#).

To add a standard note to an account

1. Locate the **Hot Note** card.

Action Code:

Result Code:

Save Hotnote Create Standard Note Reset

2. In the **Action Code** list box, click the action on the account.
3. In the **Result Code** list box, click the result of the action.
4. In the **Note** box, type a note and then click **Create Standard note**. The system adds the note to the **Notes** panel.

Available Panels ▾					
Notes ✕					
+ Add Note <input type="text"/> <input type="button" value="Q"/>					Help
Date	User	Action	Result	Comment	Private?
8/19/2013 9:06 am	gs	CO	CO	On vacation until 08/31/2013.	<input type="checkbox"/>
Previous 1 Next					

Tip: To cancel your changes, click **Reset**.

Joined Accounts

Joined Accounts Overview

The "joined accounts" feature provides visibility into a specific party and the party's multiple accounts; a specific account and the account's multiple parties; and the navigation across both contexts. The following example shows John Smith associated to Account A and Account B. It shows Jane Smith associated to Account B and Account C. Finally, it shows John Smith and Jane Smith associated to each other through the shared Account B. When viewing Account B, you see two responsible parties. Selecting John Smith brings visibility to Account A and the responsibility to Account B. Selecting Jane Smith brings visibility to Account B and the responsibility to Account C.

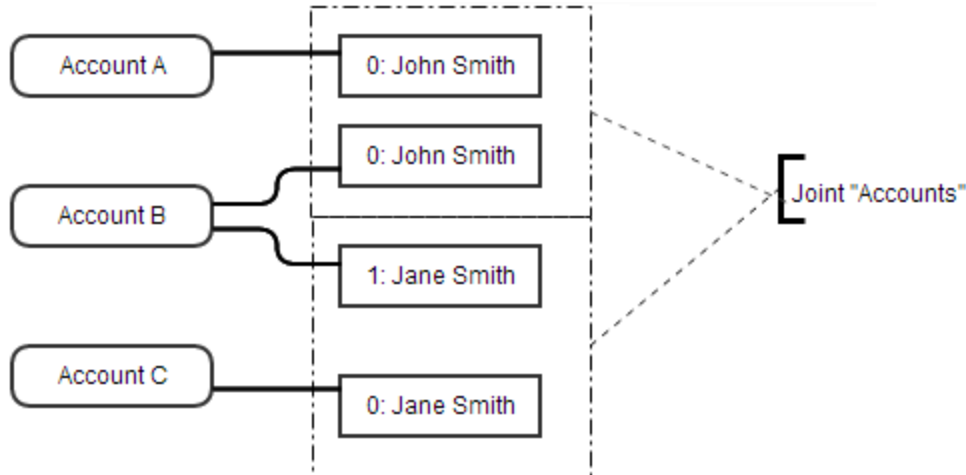

Users can view a specific account and see that account's data and its related parties. They can also view a specific party and see the related accounts and a roll-up of the responsibility of those accounts. Data points like the total amount due differ based on which party that the user selected and the party's responsibilities.

Joined Accounts Card

The **Joined Accounts** card displays the accounts associated to the responsible parties on the account. The information that appears on this card is based on whether the system is displaying the [Delinquency or Recovery Anchor](#). Open accounts appear first, sorted by received date. If there are more than four accounts to display, the system includes pagination.

Notes:

- To display one of the joined accounts, click the account.
- If closed accounts are excluded from the list, a check mark in a red box appears (as shown in the example). To include closed accounts in the list, click the check mark in the red box. An X in a blue box appears in place of the check mark.
- If closed accounts are included in the list, an X in a blue box appears. To remove closed accounts from the list, click the X in the blue box. A check mark in a red box appears in place of the X.

Delinquency anchor - Joined Accounts card

Joined (File#)	Account	Status	Client	Total Due	Past Due	Last Pd Amt	Last Paid	Worked	Contacted
 (1225)	125454212135432	NEW	CUSTOMER TWO	✓ \$250.00	\$200.00	\$0.00			
(1226)	125454669801200	NEW	CUSTOMER ONE	✓ \$250.00	\$200.00	\$0.00			
(1227)	1540302062300	NEW	CUSTOMER THREE	✓ \$250.00	\$200.00	\$0.00			
(1228)	2597312135432	NEW	CUSTOMER THREE	✓ \$250.00	\$200.00	\$0.00			

1 2

Responsible Balance:	\$0.00	\$1,000.00		
Collectable Total:	\$1,250.00	\$1,000.00	\$0.00	

Joined (File #): Unique code that the system assigned to identify the account. If a Link icon displays next to an account, it indicates that the account is the driver (main) account in the group of joined accounts.

Account: Unique code that the client assigned to identify the account.

Status: Status of the account.

Client: Name of the client associated to the account.

Total Due: Total amount due on the account.

Past Due: Amount that is past due on the account.

Last Pd Amt: Amount last paid on the account.

Last Paid: Date of last payment on the account.



Worked: Date a user last worked the account.

Contacted: Date a user last contacted a party on the account.

Responsible Balance: Total due and total past due for only the accounts in the data grid for which the focused party is responsible.

Collectable Total: Total due, total past due, and total last paid amounts for all the accounts in the data grid, regardless of whether the focused party is responsible.

Recovery anchor - Joined Accounts card

Joined (File#)	Account Status	Client	Total Due	Past Due	Last Paid	Worked	Contacted
 (1645) 541224547411	NEW	DISNEY CUSTOMER	✓ \$1,560.55	\$0.00			
(1646) 54122447031	NEW	DISNEY CUSTOMER	✓ \$650.00	\$0.00			
(1647) 654123001470	NEW	DISNEY CUSTOMER	✓ \$450.00	\$0.00			
(1648) 140012457712331	NEW	DISNEY CUSTOMER	✓ \$3,260.00	\$0.00			
 1 2			Responsible Balance:		\$0.00	\$0.00	
			Collectable Total:		\$7,280.55	\$0.00	

Joined (File #): Unique code that the system assigned to identify the account. If a Link icon displays next to an account, the account is the driver (main) account in the group of joined accounts.

Account: Unique code that the client assigned to identify the account.

Status: Status of the account.

Client: Name of the client associated to the account.

Total Due: Total amount due on the account.

Past Due: This amount is not applicable to recovery accounts so the value is always zero (0).

Last Paid: Date of last payment on the account.

Worked: Date a user last worked the account.

Contacted: Date a user last contacted a party on the account.

Responsible Balance: Total due for only the accounts in the data grid for which the focused party is responsible.

Collectable Total: Total due for all accounts in the data grid, regardless of whether the focused party is responsible.

Medical Account Details Card

The **Medical Account Details** card displays for medical accounts associated to the responsible parties on the account. The information that appears on this card is based on whether the system is displaying the [Delinquency or Recovery Anchor](#). Open accounts appear first, sorted by received date. If there are more than four accounts to display, the system includes pagination.

Notes:

- To display one of the joined accounts, click the account.
- If closed accounts are excluded from the list, a check mark in a red box appears (as shown in the example). To include closed accounts in the list, click the check mark in the red box. An **X** in a blue box appears in place of the check mark.
- If closed accounts are included in the list, an **X** in a blue box appears. To remove closed accounts from the list, click the **X** in the blue box. A check mark in a red box appears in place of the **X**.

Delinquency anchor - Medical Account Details card

Joined (File#) Account	Patient Name	Service Date	Status	Client	Total Due	Past Due	Last Pd Ar	Last Paid	Received	Last Charge Worked	Contacted
 (1206) 773820665544			NEW	CUSTOMER TWO	✓ \$250.00	\$200.00	\$0.00		2/28/11		
(1005) 7738201009121	Roy Weisen	12/25/17	NEW	ABC Co.	✓ \$150.00	\$100.00	\$0.00		2/11/11		

Responsible Balance:	\$400.00	\$300.00	
Collectable Total:	\$400.00	\$300.00	\$0.00

Joined (File #): Unique code that the system assigned to identify the account. If a Link icon displays next to an account, it indicates that the account is the driver (main) account in the group of joined accounts.

Account: Unique code that the client assigned to identify the account.

Patient Name: Patient's name.

Service Date: Date the patient received medical care.

Status: Status of the account.

Client: Name of the client associated to the account.

Total Due: Total amount due on the account.

Past Due: Amount that is past due on the account.

Last Pd Amt: Amount last paid on the account.

Last Paid: Date of last payment on the account.

Received: Date your organization received the account.

Last Charge: Date the client last charged the account.

Worked: Date a user last worked the account.

Contacted: Date a user last contacted a party on the account.

Responsible Balance: Total due and total past due for only the accounts in the data grid for which the focused party is responsible.

Collectable Total: Total due, total past due, and total last paid amounts for all the accounts in the data grid, regardless of whether the focused party is responsible.

Recovery anchor - Medical Account Details card

Joined (File#) Account	Patient Name	Service Date	Status	Client	Total Due	Past Due	Last Paid	Received	Last Charge	Worked	Contacted
(1000) 7738184767075			ACT	CUSTOMER ONE	\$967.47	\$0.00		2/11/11			
(1200) 74541021574653	Richard Kile	1/1/18	ACT	CUSTOMER ONE	\$2,000.00	\$0.00		2/11/11		8/2/17	8/2/17
(1201) 98774586630012			ACT	CUSTOMER ONE	\$250.00	\$0.00		2/11/11			

Responsible Balance:	\$3,217.47	\$0.00
Collectable Total:	\$3,217.47	\$0.00

Joined (File #): Unique code that the system assigned to identify the account. If a Link icon displays next to an account, the account is the driver (main) account in the group of joined accounts.

Account: Unique code that the client assigned to identify the account.

Patient Name: Patient's name.

Service Date: Date the patient received medical care.

Status: Status of the account.

Client: Name of the client associated to the account.

Total Due: Total amount due on the account.

Past Due: This amount is not applicable to recovery accounts so the value is always zero (0).

Last Paid: Date of last payment on the account.

Received: Date your organization received the account.

Last Charge: Date the client last charged the account.

Worked: Date a user last worked the account.

Contacted: Date a user last contacted a party on the account.

Responsible Balance: Total due for only the accounts in the data grid for which the focused party is responsible.

Collectable Total: Total due for all accounts in the data grid, regardless of whether the focused party is responsible.

Link Summary Card

The **Link Summary** card contains summary information for open accounts linked to the account. Linked accounts can belong to different clients.

Linked Accounts: 3 Linked Balance: \$3,217.47

Client	Accounts	Balance
0000001 - CUSTOMER ONE	2	\$1,217.47
0000015 - LIQUID LAT CUSTOMER	1	\$2,000.00

Linked Accounts: Total number of accounts in the linked account group for all associated clients.

Linked Balance: Total balance of the accounts in the linked account group for all associated clients.

Client: Name of the client associated to the linked accounts.

Accounts: Number of accounts in the linked account group associated to the client.

Balance: Total balance of the accounts in the linked account group associated to the client.

Party Card

The **Party** card contains contact information for a party on the account.

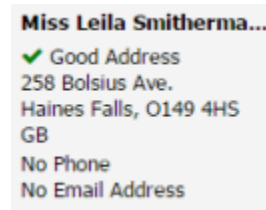

[Name] Party's name.

Address: Party's address.

Phone: Party's telephone number.

Email: Party's email address.

Party Navigator Card

The **Party Navigator** card contains information regarding a party on the account.

Richard Kile	Primary RP	Richard Kile
Is Responsible	Yes	
Authorized For Customer	None	
Customer On Hold		Account On Hold Broken Promise
Open Complaint	No	National ID 111223333
Open Dispute	No	Address ✓ 12 JAMES ROAD APT G ALLENTOWN , PA 18101
Care/Hardship	No	Email ✓ Richard.Kile@mymail.com
Legal Representation	No	Mobile Phone
Bankruptcy/Insolvency	No	Home Phone 0021
Deceased Information	No	Work Phone
Debt Management	No	

Column 1

[Name]: Name of a party on the account. If more than one party exists on the account, you can click the list box to select another party for whom to view information.

Is Responsible: Indicates whether the party is responsible for the account.

Authorized For Customer: Customer for whom the party is authorized to discuss the debt and pay on the account.

[Customer Alert]: If the customer is on hold, a "Customer On Hold" alert appears in red.

Tip: You can rest your mouse on the alert to view more information about it. For system-placed holds, the information displayed is the date the system placed the hold and the reason (for

example, complaint). For user-placed holds, the information displayed is the hold expiration date and the reason the user provided when placing the hold. If both the system and a user placed a hold, the information that displays is for whichever hold occurred first.

Note: If any of the following are true, the verbiage appears in red.

Open Complaint: Indicates whether there is an open complaint on the account.

Open Dispute: Indicates whether there is an open dispute on the account.

Care/Hardship: Indicates whether there is a customer care or financial hardship case on the account.

Legal Representation: Indicates whether the account is in litigation.

Bankruptcy/Insolvency: Indicates whether there is a bankruptcy or insolvency on the account.

Deceased Information: Indicates whether a party on the account is deceased.

Debt Management: Indicates whether a party on the account engaged a Consumer Credit Counseling Service (CCCS) to negotiate settlement or payment arrangements on the debt.

Column 2

Primary RP: Name of the primary responsible party on the account.

[Account Alert]: If there are account alerts (for example, account is on hold or has a broken promise), the alerts appear in red.

Tip: You can rest your mouse on the alert to view more information about it. For example, if the account has a broken promise, the information displayed is the date the broken promise occurred and the promise amount. If a user placed the account on hold, the information displayed is the hold expiration date and the reason the user provided when placing the hold.

National ID: Unique number that the government issued to identify the party shown in column 1 of the card (for example, social security number or state ID).

Address: Mailing address of the party shown in column 1 of the card.

Email: Email address of the party shown in column 1 of the card.

Mobile Phone: Cell number of the party shown in column 1 of the card.

Home Phone: Home number of the party shown in column 1 of the card.

Work Phone: Work number of the party shown in column 1 of the card.

Note: If the party has multiple phone numbers of the same type (for example, work), the system displays only one phone number for that type. To view all phone numbers for the account, see [View Phone Numbers for an Account](#).

Pending Payments Card

The **Pending Payments** card displays pending payments for the account.

Pay Arrangement Items:	1
Date Next Payment Due:	11/17/14
Arrangement Ends:	11/17/14
Amount of Postdates:	\$2.00
Balance After Arrangement:	\$398.00
Settlement in Progress	

Pay Arrangement Items: Number of items in the payment arrangement.

Date Next Payment Due: Due date of the next payment in the arrangement.

Arrangement Ends: Date the payment arrangement ends.

Amount of Postdates: Total amount for all post-dated payments in the arrangement.

Balance After Arrangement: Account balance after the system applies the payments in the arrangement.

[Message area]: Messages about the arrangement, such as "Settlement in Progress" and "Broken Promise."

Support Queue Details Card

The **Support Queue Details** card displays support queue details for the account. This card displays for accounts assigned to any support queue, such as clerical or supervisor. If an account belongs to more than one support queue, you can select the queue to view.

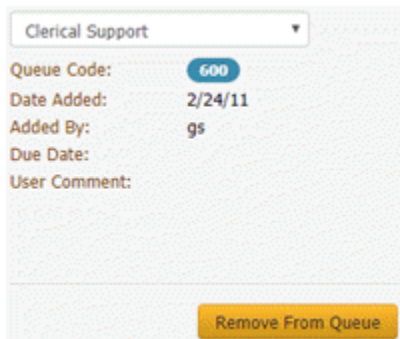

Queue: Queue for which to display details.

Queue Code: Code that identifies the support queue.

Date Added: Date the user added the account to the support queue.

Added by: ID of the user who added the account to the support queue.

Due Date: Date the user requested a response to the support issue.

User Comment: Reason the user assigned the account to the support queue.

Remove From Queue: Removes the account from the queue specified in the **Queue** list box.

Account Detail

Account Detail

You can view and modify account details using the **Account Detail** toolbar.

Balance Details Major Dates Additional Information Contact Analysis Client Guidelines Link Details

View Account Balance Details

Use the **Balance Details** panel to view account balance details for the account. The information that appears on this panel is based on whether the account is a delinquency or recovery account.

To view account balance details

- In the **Account Detail** toolbar, click **Balance Details**. One of the following occurs:
 - For an account that the client charged off, the [current balance](#) information appears.
 - For an account that the client didn't charge off, the [history balance](#) information appears.

Current Balance

The **Current Balance** panel shows the amounts for each money bucket for recovery accounts.

Current Balance

	Original	Adjusted	Net Original	Accrued	Paid	Current
Principal	\$292.87	\$0.00	\$292.87	\$0.00	\$0.00	\$292.87
Interest	\$0.00	\$0.00	\$0.00	\$0.00	\$0.00	\$0.00
Collection Costs	\$0.00	\$0.00	\$0.00	\$0.00	\$0.00	\$0.00
Bad Check Chgs	\$0.00	\$0.00	\$0.00	\$0.00	\$0.00	\$0.00
Court Cost	\$0.00	\$0.00	\$0.00	\$0.00	\$0.00	\$0.00
Attorney Fees	\$0.00	\$0.00	\$0.00	\$0.00	\$0.00	\$0.00
Misc	\$0.00	\$0.00	\$0.00	\$0.00	\$0.00	\$0.00
Not Used	\$0.00	\$0.00	\$0.00	\$0.00	\$0.00	\$0.00
Not Used	\$0.00	\$0.00	\$0.00	\$0.00	\$0.00	\$0.00
Transaction Charges	\$0.00	\$0.00	\$0.00	\$0.00	\$0.00	\$0.00
Total	\$292.87	\$0.00	\$292.87	\$0.00	\$0.00	\$292.87
						Overpaid
Amount:						\$7.13

Help

Money buckets: (Rows) Categories used to group amounts associated to the account (for example, principal and interest).

Original: Balance of each money bucket on the day your organization received the account.

Adjusted: Amount the system or user adjusted each money bucket after your organization received the account.

Net Original: Original balance of each money bucket, plus or minus adjustments.

Accrued: Accrued interest (calculated interest, transaction fees).

Paid: Payment amounts received for each money bucket after your organization received the account.

Current: Current balance of each money bucket.

Total: (Last row) Total amounts for each of the columns.

Overpaid: Amount overpaid on the account (account balance less the amount paid).

History Balance

The **History Balance** panel shows account aging information by month and year for delinquency accounts.

History Balance

Linked Accounts

	Jan	Feb	Mar	Apr	May	Jun	Jul	Aug	Sep	Oct	Nov	Dec
2013	Current			90	90		30					
2012				60								60
2011			120	120			60	180				

[Help](#)

Linked Accounts: If selected, linked accounts are included in the panel.

View or Modify Account Dates

Use the **Account Dates** panel to view important dates associated to the account. To modify custom dates, you must have the Update User Date 1 Permission, Update User Date 2 Permission, and Update User Date 3 Permission.

To view or modify account dates

1. In the **Account Detail** toolbar, click **Major Dates**.

Account Dates

Received:	<input type="text" value="2/11/11"/>	Client Date Last Paid:	<input type="text" value="4/8/08"/>	Amount:	\$ <input type="text" value="0"/>	Custom Date 1:	<input type="text"/>
Date Closed:	<input type="text"/>	Client Date Last Charge:	<input type="text"/>	Amount:	\$ <input type="text" value="0"/>	Custom Date 2:	<input type="text"/>
Last Worked:	<input type="text"/>	Delinquency:	<input type="text" value="1/25/09"/>			Custom Date 3:	<input type="text"/>
Last Contacted:	<input type="text"/>	ChargeOff:	<input type="text" value="1/25/09"/>				
Last Paid:	<input type="text" value="10/29/14"/>						
Contract:	<input type="text"/>						

[Save](#) [Help](#)

Received: Date your organization received the account.

Date Closed: Date the system or a user closed the account.

Last Worked: Date the user last worked the account.

Last Contacted: Date your organization last contacted the customer.

Last Paid: Date your organization last received a payment.

Contract: Date the customer started the account with the client.

Client Date Last Paid: Date the client last received a payment.

Amount: (Client Date Last Paid Amount) Payment amount that the client reported as last received on the account.

Client Date Last Charge: Date the client last charged the account.

Amount: (Client Date last Charge Amount) Amount the client last charged the account.

Delinquency: Date the account became delinquent.

Charge Off: Date the client charged off the account.

Custom Date 1 through **Custom Date 3:** A user-defined date. The labels differ, depending on how your organization configured your system.

- If you have the permissions to modify the user dates, complete the information and then click **Save**.

View Additional Account Information

Use the **Additional Info** panel to view miscellaneous account information for the account.

To view additional account information

- In the **Account Detail** toolbar, click **Additional Information**.

Additional Info

Account Type: Class:	<input type="text"/>	Creditors: Original:	<input type="text" value="PNC BANK"/>	Client:	<input type="text" value="0000001 - ABC CLIENT"/>
Claim Type:	<input type="text"/>	Previous:	<input type="text"/>	Division:	<input type="text"/>
Account IDs: Original:	<input type="text" value="7738201009121"/>	Interest: Rate:	<input type="text" value="0"/>	District:	<input type="text"/>
ID 1:	<input type="text"/>	Date Assessed:	<input type="text" value="2/11/11"/>	Branch:	<input type="text"/>
ID 2:	<input type="text"/>				

Secured Loan

[Help](#)

Account Type

Class: Class of business assigned to the account for reporting to credit bureaus.

Claim Type: Claim type that the system uses to determine the statute of limitations.

Account IDs

Original: Account ID the creditor assigned to the account originally.

Secured Loan: If selected, the customer pledged collateral against the loan.

ID 1: User-defined account identification.

ID 2: User-defined account identification.

Creditors

Original: Original creditor assigned to the account.

Previous: Creditor previously assigned to the account.

Interest

Rate: Interest rate of the loan.

Date Assessed: Date the client assessed interest.

Client: Client associated to the account.

Division: Client's division.

District: Client's district.

Branch: Client's branch.

View Contact Analysis Information

Use the **Contact Analysis** panel to verify the number of times each day that your organization attempted to contact the customer regarding the account. You can use this information to determine what time to set up a reminder.

The system displays the following information:

- Morning, afternoon, evening, and weekend contacts by both a user and a dialer.
- Scoring information that the system imported (custom interfaces only.)
- Number of days that your organization has held the account.
- Percentage of the balance currently recovered.
- Total amount collected, with the average amount collected each time your organization contacted the customer or worked the account.

To view contact analysis information

- In the **Account Detail** toolbar, click **Contact Analysis**.

Contact Method		Worked and Contacted by Hour			Recovery Stats			
	User (non-Dialer)		Dialer	Time	Worked	Contacted	Score:	
	Worked	Contacted	Worked	Contacted			Age:	922
Morning	0	0	0	0			Recovered:	0
Afternoon	0	0	0	0			Amount Collected:	0
Evening	0	0	0	0			Per Work:	0
Weekend	0	0	0	0			Per Contact:	0

Help

User (non-Dialer) Worked (Morning, Afternoon, Evening, Weekend): Number of times users worked the account during the specified time of day.

User (non-Dialer) Contacted (Morning, Afternoon, Evening, Weekend): Number of times users contacted someone regarding the account during the specified time of day.

Dialer Worked (Morning, Afternoon, Evening, Weekend): Number of times that the dialer worked the account during the specified time of day.

Dialer Contacted (Morning, Afternoon, Evening, Weekend): Number of times that the dialer contacted someone regarding the account during the specified time of day.

Time: Hour of day the user worked the account or contacted someone regarding the account.

Worked: Number of times the user worked the account at the specified time of day.

Contacted: Number of times the user contacted someone regarding the account at the specified time of day.

Score: Indicates how collectable the account is. This information comes from a file that your organization receives from an outside vendor.

Age: Number of days your organization has held the account.

Recovered %: Percent of the account balances that your organization received in payments.

Amount Collected: Total amount collected on the accounts.

Per Work: Total amount collected for worked accounts.

Per Contact: Total amount collected for contacted accounts.

View Client Guidelines

Use the **Client Guidelines** panel to view the work plan, settlement guidelines, and miscellaneous information for the client on the account. Your organization specifies this information when setting up a client. For more information, see Maintain Client Guidelines.

To view client guidelines

- In the **Account Detail** toolbar, click **Client Guidelines**.

DEFAULT CUSTOMER
 123 MAIN STREET
 JACKSONVILLE, FL 32246
 555-1212

Work Plan
 Work new biz 2 days, all other accounts every 3 days.

Settlement Guidelines
 80% Blanket Settlement authorized. Anything lower see your supervisor

Misc Info
 Testing Misc Info in customer properties.

 Help

Work Plan: Displays a work plan for the account.

Settlement Guidelines: Displays settlement guidelines for the account.

Miscellaneous Information: Displays miscellaneous information for working an account.

View Information for Linked Accounts

Use the **Link Details** panel to view information about accounts that are linked to the account. Linked accounts can belong to different clients.

To view information for linked accounts

1. In the **Account Detail** toolbar, click **Link Details**. One of the following occurs:
 - For a first-party active collections account, the [first-party active collections](#) information appears.

- For a first-party recovery or third-party collections account, the [first-party recovery or third-party collections](#) information appears.

Note: To display a linked account, in the Account column, click the account number.

2. To refresh the data in the data grid, click the Refresh icon in the first column and of the data grid's header row.

First-party active collections

The first-party active collections anchor shows aging information for each linked account.

Accounts: 2
 Link Driver Account Number: 773820665544
 Link Driver File ID: 1206
 Link ID: 5

	Client	(File#) Account	Aging	Status	Recieved	Last Charge	Cycle	Current	Past	Total	30	60	90	120
🚩	CUSTOMER TWO	(1206) 773820665544	150	NEW	2/28/11		02/09	\$50.00	\$200.00	\$250.00	\$50.00	\$50.00	\$50.00	\$50.00
🔗	CUSTOMER ONE	(1005) 7738201009121	90	NEW	2/11/11		02/09	\$50.00	\$100.00	\$150.00	\$50.00	\$50.00		

🔗 Help

Accounts: Number of accounts in the linked account group, including the driver account.

Link Driver Account Number: Unique code that the client assigned to identify the link driver account. In the data grid, a Flag icon signifies the driver account and a Chain Link icon signifies a linked account.

Link Driver File ID: Unique code that the system assigned to identify the link driver account.

Link ID: Unique number that identifies the linked account group.

Client: Name of the client on the account.

(File #) Account: Unique code that the client assigned to identify the account.

Aging: Age of the account, which is the greatest number of days the account is past due.

Status: Status of the linked account.

Received: Date your organization received the account.

Last Charge: Amount the client last charged the account.

Cycle: Date the account's next billing cycle begins.

Current: Amount that is not yet due.

Past: Total amount that is past due on the account.

Total: Total amount due on the account. This amount is the sum of the current and total amounts.

[Delinquency Aging Buckets]: Time periods for reporting past due amounts. In the example, the labels are 30, 60, 90, and 120. Your organization defines these labels. For more information, see the Delinquency Aging Bucket Labels permission.

First-party recovery or third-party collections

The first-party recovery or third-party collections anchor shows account balance and payment information for each linked account.

Accounts: 3
 Link Driver Account Number: 7738184767075
 Link Driver File ID: 1000
 Link ID: 1

	Portfolio	(File#) Account	Status	Received	Last Charge	Balance	Charge Off	Placed	Interest	Paid	Last Pay	Amount of Postdates	Next
	CUSTOMER ONE	(1000) 7738184767075	ACT	2/11/11		\$967.47	1/31/11	\$967.47	\$0.00	\$0.00			\$0.00
	CUSTOMER ONE	(1201) 98774586630012	ACT	2/11/11		\$250.00		\$250.00	\$0.00	\$0.00			\$0.00
	CUSTOMER ONE	(1200) 74541021574653	ACT	2/11/11		\$2,000.00		\$2,000.00	\$0.00	\$0.00			\$0.00

Help

Accounts: Number of accounts in the linked account group, including the driver account.

Link Driver Account Number: Account number for the main account in the linked accounts group. In the data grid, a Flag icon signifies the driver account and a Chain Link icon signifies a linked account.

Link Driver File ID: Unique number the system assigned to the link driver account to identify it.

Link ID: Unique number that identifies the linked account group.

Client: Name of the client on the account.

(File #) Account: Account number that the client assigned to the account.

Status: Status of the linked account.

Received: Date your organization received the account.

Last Charge: Amount the client last charged the account.

Balance: Account balance.

Charge Off: Date the client charged off the account.

Placed: Amount on the account that the client placed with an outside agency.

Interest: Interest on the account.

Paid: Amount paid on the account.

Last Pay: Last payment date.

Amount of Postdates: Post-dated check and promise amount.

Next: Next payment date.

Account Links

Account Links

Linked accounts are separate accounts that your organization holds for the same responsible party. Link Console links accounts for the same party automatically based on criteria that your organization configured in Link Console. The Manage Links feature in Latitude allows you to add and remove links manually. You can link an account to an existing party on another account, create a party to link to, and remove account links. Latitude considers all parties in the link group to be the same person.

Data merge

When you link parties, Latitude merges the following data:

- Address records
- Email address records
- Care and financial hardship records (uses the data changed most recently as the current data)
- Income and expenditure records (uses the data changed most recently as the current data)
- Complaint records (uses the data changed more recently as the current data)

Add a Link to an Account

Use the **Manage Links** dialog box to link a party to the account. You can link to an existing party or create a party to link to. You must have the Allow Manual Linking/Unlinking Permission.

To add a link to an account

1. In the **Account** toolbar, click **Linking**.

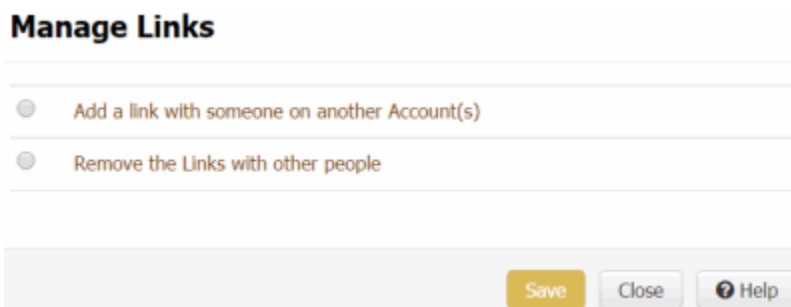

2. Click **Add a link with someone on another account**.

3. In the **Account Search** box, type the file number to search for and then click the Search icon. If an account matches the specified file number, Latitude populates the list box with the parties associated to the matching account.
4. Do one of the following:
 - To link to a party displayed in the **Add a link with** list box, click the party's name and then click **Save**. One of the following occurs:
 - If a party that you are linking has an active arrangement, a message displays indicating that you cannot create a link. Click **Close**.
 - If an account in a linked group has a court case, a message displays indicating that you cannot create a link. Click **Close**.
 - If the party that you selected to link to is linked to other parties, a message displays asking whether you want to link all the parties. To link all the parties, click **OK**. Latitude links the parties and merges certain data. To close the dialog box without linking the parties, click **Cancel**.
 - If no messages display, Latitude links the parties and merges certain data.
 - To create a party to link to, in the **Add a link with** list box click **None (create a record)** and then click **Save**. Latitude creates a party with the same name as the account displayed currently and links to that party. Latitude merges certain data with the new party. Use the **Customers** panel to update other data for the party as necessary. For more information, see [Customers](#).

Note: For more information about what data Latitude merges, see [Account Links](#).

Remove all Links to an Account

Use the **Manage Links** dialog box to remove all party links to the account. You must have the Allow Manual Linking/Unlinking Permission.

To remove all links to an account

1. In the **Account** toolbar, click **Linking**.

Manage Links

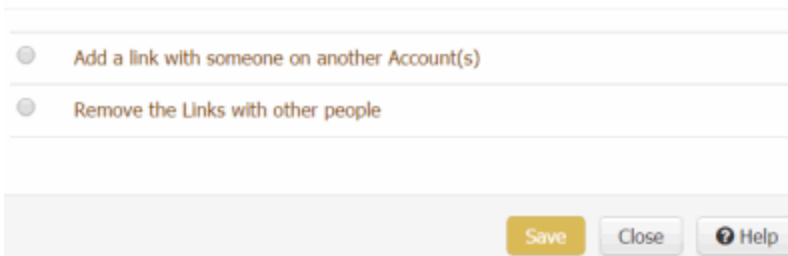

Add a link with someone on another Account(s)

Remove the Links with other people

Save Close Help

2. Click **Remove the links with other people**. The **Copy Person-centric Data** check box appears.

Manage Links

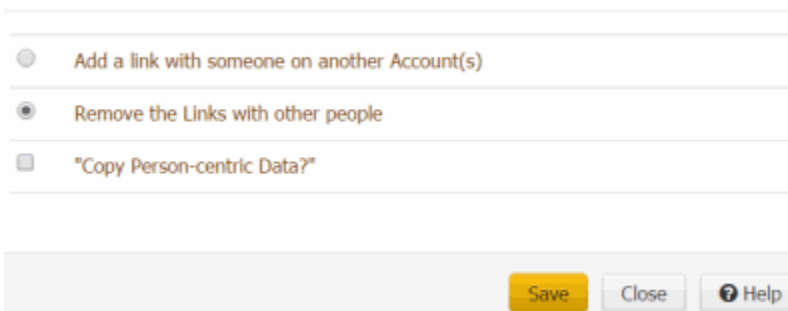

Add a link with someone on another Account(s)

Remove the Links with other people

"Copy Person-centric Data?"

Save Close Help

3. To copy the person's address; email; care and financial hardship data; income and expenditure data; and complaints data to a new joined customer ID, select the **Copy Person-centric Data** check box.
4. Click **Save**. Latitude removes the account from the link group.

Notes:

- If the party displayed currently is a member of an active arrangement, a message displays indicating that you cannot remove the link. Click **OK**.
- If an account in the linked group has a court case, a message displays in the status bar indicating that you cannot remove the link.

Account Reminders

Account Reminders

You can set a reminder for an account so that a user can carry out a specific action at a specific date and time. For example, you can set a reminder to have a user call an account at a certain time of day. Reminders appear for the desk associated to the account for which you set the reminder. If an account moves to another desk, the reminders stay with the account. Reminders continue to appear for the desk until you dismiss them.

Set a Timed Reminder

Use the **Set Timed Reminder** dialog box to set a reminder for an account associated to your desk and have the reminder appear at a specific date and time. You cannot set a reminder for a date and time in the past, a date that exceeds the maximum reminder days allowed for the desk, or for a closed account. For more information, see Add a Desk. If you have the Set Reminders for Others Permission, you can set reminders for accounts associated to other desks.

To set a timed reminder

1. In the **Account** toolbar, click **Reminder**.

Set Timed Reminder

Date	Account ID	Date
10:32 PM	1200	09/15/2020

Time	Worked	Contacted
6:00 PM	2	2

Date	PM	Count
9/15/20	10	1

Date: Date for the reminder to appear.

Time: Time for the reminder to appear.

Desk: Desk for the reminder to appear.

Contact History: Time of day and the number of times a user worked or contacted the account.

Calendar: Shows the current day (shaded yellow) and days that have reminders set (blue box with the number of reminders).

2. To set a reminder, do the following:
 - a. In the **Date** box, type or select the date for the reminder to appear.

- b. In the **Time** box, type or select the time for the reminder to appear.
- c. In the **Desk** list box, click a desk and then click **Save**. The system closes the **Set Timed Reminder** dialog box and increases the **Reminders** counter in the **Status** bar by 1.

Notes:

- The system assigns the account to queue level 000, which doesn't allow the account to queue up for work until you dismiss the reminder. We recommend that you dismiss reminders in a timely manner to minimize the effect on the work queue. For more information, see Queue Level Codes for queue level 000.
- You cannot set a reminder on a closed account. The **Save** button is either not available or the system displays an error message when you click it.

- 3. To view details for an existing reminder, in the calendar, click the date that has a reminder set. The reminders for that date appear in the data grid beneath the calendar.

The screenshot shows a calendar for December 2016. The date December 21st is highlighted in yellow. Below the calendar, there are two data grids showing reminder details for that date.

Date	AM	Count	Date	PM	Count
12/21/16	8	2	12/21/16	9	1
12/21/16	11	1			

Date: Date for the reminders to appear.

AM/PM: Time of day for the reminders to appear.

Count: Number of reminders set for the date and time of day.

All the scheduled reminders for the selected desk and date appear in the grid next to the calendar.

Time	Account ID	Date
2:51 PM	1638	09/01/2020
6:19 PM	1239	09/01/2020
6:21 PM	1724	09/01/2020

Time: Time for the reminder to appear.

Account ID: Account IDs for the reminder to appear.

Date: Date for the reminders to appear.

View Timed Reminders

Use the **Reminders** dialog box to view timed reminders for accounts associated to the desk that you are working. A notification appears in the **Status** bar that indicates the number of reminders that exist for the desk.

To view timed reminders

1. Check the **Status** bar for reminders. The following example shows that the desk has two reminders.

DB Server Name: MaltlavaSystest	Database: Collect2000	Previous Login: Jun 8, 2016 10:49:54 am	Time on Account: 00:00:03	Reminders: 2
---------------------------------	-----------------------	---	---------------------------	--------------

2. In the **Status** bar, click **Reminders**.

Reminders					
File Number	Name	Client	Balance	Due	Actions
1005	Wiesen, Roy	CUSTOMER ONE	1307.21	1/8/16 7:24 am	Dismiss Reschedule
1003	Severino, Eva M	CUSTOMER ONE	7960.47	1/8/16 7:25 am	Dismiss Reschedule

Dismiss All Close Help

File Number: Unique code that the system assigned to identify the account.

Name: Name of the customer associated to the account.

Client: Name of the client who holds the account.

Balance: Balance due on the account.

Due: Date and time the reminder is due. Reminders display in date and time order.

3. To display an account, in the **File Number** column, click the file number. The **Reminders** dialog box closes and the account displays.

Note: The reminder continues to appear for the desk until you dismiss it. For more information, see [Reschedule or Dismiss a Timed Reminder](#).

Reschedule or Dismiss a Timed Reminder

Use the **Reminders** dialog box to reschedule a reminder so that it reappears later or dismiss a reminder so that it doesn't reappear again. Reminders continue to appear periodically until you reschedule or dismiss them. We recommend that you dismiss reminders in a timely manner to minimize the effect on the work queue. For more information, see Queue Level Codes for queue level 000.

To reschedule or dismiss a timed reminder

1. If a reminder exists for an account associated to the desk that you are working and the scheduled date and time have passed, the **Reminders** dialog box appears.

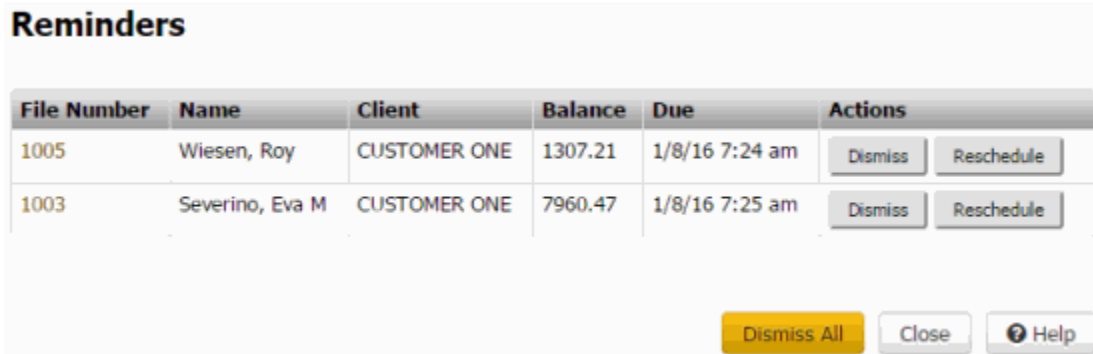

2. To display an account, click the account number. The **Reminders** dialog box closes.
3. To reschedule a reminder, do the following:
 - a. Click **Reschedule**. The **Set Timed Reminder** dialog box appears.
 - b. Modify the information and then click **Save**. For more information, see [Set a Timed Reminder](#).
4. To dismiss a reminder, do one of the following:
 - To dismiss a single reminder, click **Dismiss**.
 - To dismiss all of the reminders, click **Dismiss All**.

The system reassigns the account to the queue level that applies based on account activity or condition.

5. To close the dialog box without rescheduling or dismissing the reminder, click **Close**. The **Reminders** dialog box reappears periodically until you reschedule or dismiss the reminder.

Set an Account Follow-up Date

Use the **Set Account Follow-up Date** dialog box to set a follow-up date on an account. The account appears on the Agent Desktop on the specified day when you attempt to move to the next account while working a queue. You cannot set a follow-up for a date in the past, or a date that exceeds the maximum follow-up days allowed for the desk. For more information, see [Add a Desk](#). To set a follow-up date, you must have the Set Follow-up Date Permission.

To set an account follow-up date

1. In the **Account** toolbar, click **Follow-up**.

Set Account Follow-up Date

Follow-up date: 

Days from today:

Follow-up time: Anytime Afternoon
 Morning Evening

Follow-up Date: Date to follow up on the account.

Tomorrow: Sets the account to display tomorrow.

Days from Today: Sets the account to display a specific number of days from the current date.

Follow-up Time: If selected, sets the account to display at a specific time of day.

2. Complete the information and then click **Save**.

Statuses

Statuses

An account status changes based on system activities or when you choose to change it. Only the status codes for which you have permissions are available to you. You can:

- Select a status from the **Status** menu.
- Open the **Change Account Status** dialog box and select a status.
- Specify the statuses to include in the **Status** menu.

Note: Codes in blue signify an open status and codes in red signify a closed status.

Select a Quick-pick Account Status

Use the **Status** menu to select an account status from the "quick-pick" list of statuses. You must have the Change Status Permission. For information about maintaining the "quick-pick" list, see [Maintain the Quick-pick Account Status List](#).

To select a quick-pick account status

- In the **Account** toolbar, click **Status** and then click a status option (for example, **HOT**.) The system changes the account status to the selected status.

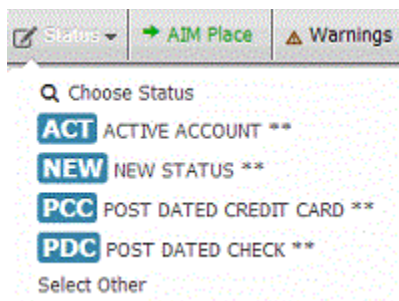

Change an Account Status

Use the **Change Account Status** dialog box to change the status of an account. The system only displays the status codes for which you have permissions. For more information, see Change Status Permission.

To change an account status

1. In the **Account** toolbar, click **Status** and then click **Choose Status**.

Change Account Status

Status	Description
ACT	ACTIVE ACCOUNT **
AEX	ALL EFFORTS EXHAUSTED
ATY	ATTORNEY REPRESENTED ON ACCT
B07	CHAPTER 7 BANKRUPTCY **
B11	CHAPTER 11 BANKRUPTCY
B13	CHAPTER 13 BANKRUPTCY **
BKY	BANKRUPTCY PENDING **
CCC	CONSUMER CREDIT COUNSELING
CCR	CLOSED CLIENT REQUEST
CND	CEASE AND DESIST

- Click the status to assign to the account and then click **Save**.

Note: If the account is linked to another account (and this feature is available to you), the **Select Accounts** dialog box appears. Do the steps to [Select Accounts](#).

Select Accounts

Use the **Select Accounts** dialog box to select multiple linked accounts for which to change the account status or request a letter, depending on which task you are performing. This dialog box displays for linked accounts.

To select accounts

- Do one of the following:
 - [Change an Account Status](#)
 - [Request a Letter](#)

The **Select Accounts** dialog box appears.

Select Accounts

<input checked="" type="checkbox"/>	File #	Account	Status	Balance	Has Active Arrangement?	Client	Patient Name	Date of Service	Contract Date	Chargeoff Date
<input checked="" type="checkbox"/>	1005	7738201009121	NEW	\$150.00	<input type="checkbox"/>	0000001			5/19/09	1/31/11
<input checked="" type="checkbox"/>	1206	773820665544	NEW	\$250.00	<input type="checkbox"/>	0000002			5/19/09	

Advanced

Note: If closed accounts are excluded from the list, a check mark in a red box appears (as shown in the example). If closed accounts are included in the list, an **X** in a blue box appears.

2. Do one of the following:
 - To include closed accounts in the list, click the check mark in the red box. An **X** in a blue box appears in place of the check mark.
 - To remove closed accounts from the list, click the **X** in the blue box. A check mark in a red box appears in place of the **X**.
3. To select the accounts for which to change the status or request a letter, do one of the following:
 - To include all the linked accounts, select the check box next to **Select/Deselect All** in the column heading.
 - To exclude all the linked accounts (except the account you are working), clear the check box next to **Select/Deselect All** in the column heading.
 - To include an individual linked account, select the corresponding check box.
 - To exclude an individual linked account, clear the corresponding check box.
4. To specify advanced options, do the following:
 - a. Click **Advanced**. The advanced options appear.

▼ Advanced

Client:	<input type="text"/>	Patient:	<input type="text"/>	Service Date:	<input type="text"/>	<input type="button" value="📅"/>
<input type="button" value="Apply"/>		<input type="button" value="Clear"/>				

- b. To include accounts for a specific client, in the **Client** list box, click the client name.
 - c. To include accounts for a specific medical patient, in the **Patient** list box, click the patient name.
 - d. To include accounts for a specific date that the patient received medical care, in the **Service Date** list box, click the service date.
 - e. Click **Apply**.
5. Click **Save**. If you are changing the status and the selected accounts have an active payment arrangement, a confirmation dialog box appears. Click **OK**.

The system either changes the status of the specified accounts or requests a letter for the specified accounts, depending on what action lead you to this dialog box.

Maintain the Quick-pick Account Status List

Use the **Change Quick Status Choices** dialog box to maintain the "quick-pick" list of statuses that display in the **Status** menu.

To maintain the quick-pick account status list

1. In the **Account** toolbar, click **Status** and then click **Select Other**.

Change Quick Status Choices

- In the **Quick Status Item** list boxes, click a status to include in the **Status** menu and then click **Save**. You can specify up to eight statuses to display in the **Status** menu.

Standard Status Codes

The following table lists standard status codes and their description. Your organization may have defined more status codes. You can only use the status codes for which you have the Change Status Permission.

*Indicates system-utilized status codes.

Code	Description	Type	Return Days
ACT*	Active Accounts	Active	0
AEX	All Efforts Exhausted	Closed	30
ATY	Attorney Represented on Account	Closed	0
B07*	Chapter 7 Bankruptcy	Closed	0
B13*	Chapter 13 Bankruptcy	Closed	0
BKY*	Bankruptcy	Closed	0
CCC	Consumer Credit Counsel	Active	0

CCR	Closed Client Request	Closed	0
CND	Cease and Desist	Active	0
DEC	Customer is Deceased	Closed	0
DIP	Customer in Prison	Closed	0
DSP	Customer Disputes Balance	Active	0
DUP	Duplicate	Active	0
HLD	Client put on Hold	Active	0
HOT	Special Interest	Active	0
LET	Special Letter Series	Active	0
LOP	Letter of Protection	Active	0
NEW*	New Business	Active	0
NPC*	No More Postdated Checks	Active	0
NSF*	Bounced Check Outstanding	Active	0
PCC*	Pending Credit Card payments	Active	0
PDC*	Postdated Check	Active	0
PIE	Placed in Error	Closed	0
PIF*	Account Paid in Full	Closed	30
PND	Pending	Active	0
PPA*	Partial Payment Arrangement	Active	0
PPI	Partial Payment Inactive	Active	0
RCL	Recalled by Client	Closed	0
SIF*	Account is Settled in Full	Closed	30

Latitude Printable Help

SKP	Skip Account	Closed	30
-----	--------------	--------	----

Processes and Stages

Processes and Stages

You can start an account in the first stage in a process and move the account to the next or previous stage in a process. You can also view the processes and stages available to you based on your permissions.

Manual Process Stages

Start an Account in a Process

Use the **Start** option in the **Processes** menu to start an account in the first stage of a process. You can only start an account in the first stage that your organization set up for the process. However, you can move the account to subsequent stages within the process after you start the process.

To start an account in a process

- In the **Account** toolbar, click **Processes > Start > [process name]**. The anchor card for the selected process appears in the **Account Information** panel. The following example shows that the account is in the Confirmation stage of the Dispute process. It also shows that the process has two stages and that the account is in the first stage.



Move an Account to the Next Process Stage

Use the **Current** option in the **Processes** menu to move an account to the next stage of a process. You cannot select a specific stage to which to move the account. However, you can continue moving the account to subsequent stages within the process until you get to the stage you want.

To move an account to the next process stage

- In the **Account** toolbar, click **Processes > Current > [process name - stage name] > Next**. The system updates the anchor card in the **Account Information** panel to reflect the current stage. The following example shows that the account is in the Rejected stage of the Dispute process. It also shows that the process has two stages and that the account is in the second stage.

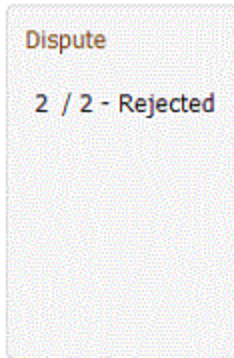

Move an Account to the Previous Process Stage

Use the **Current** option in the **Processes** menu to move an account to the previous stage of a process. You cannot select a specific stage to which to move the account. However, you can continue moving the account to previous stages within the process until you get to the stage you want.

To move an account to the previous process stage

- In the **Account** toolbar, click **Processes** > **Current** > [process name - stage name] > **Previous**. The system updates the anchor card in the **Account Information** panel to reflect the current stage. The following example shows that the account is in the Confirmation stage of the Dispute process. It also shows that the process has two stages and that the account is in the first stage.



View the Available Processes and Stages for an Account

Use the **Available** option in the **Processes** menu to view the processes and stages that are available to you based on your permissions.

To view the available processes and stages for an account

- In the **Account** toolbar, click **Processes** > **Available** > [process name]. A list of available stages for the selected process appears. The following example shows that the Bankruptcy and Dispute processes are available for the account, and the Dispute process has two stages: Confirmation and Rejected.

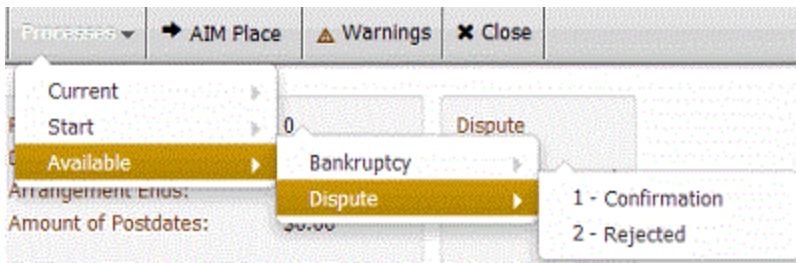

Placements and Recalls

Placements and Recalls

You can flag accounts for placement with or recall from outside collection agencies or attorneys. When a user generates placement and recall files using the AIM program, the system includes the accounts that the system flagged for placement or recall in the corresponding files. The system sends the files to the appropriate agencies or attorneys for processing. For more information about AIM, see the AIM documentation. You must have the AIM Place/Recall Functionality Permission to place and recall accounts from within Collector.

The following menu states are available based on the status of the placement or recall.

- If the **AIM Place** menu option is visible and available, an outside agency or attorney doesn't hold the account currently.
- If the **AIM Place** menu option is visible but not available, the account is pending placement with an outside agency or attorney.
- If the **AIM Recall** menu option is visible and available, the account is available for recall from an outside agency or attorney.
- If the **AIM Recall** menu option is visible but not available, the account is pending recall from an outside agency or attorney. A pending recall occurs when a user recalls an account manually or when the automatic recall date has passed.

Place an Account With an Agency or Attorney

Use the **AIM Placement** dialog box to flag an account for placement with an outside collection agency or attorney.

Notes:

- If the AIM Place menu option is visible and available, an outside agency or attorney doesn't hold the account currently.
- If the AIM Place menu option is visible but not available, the account is pending placement with an outside agency or attorney.

To place an account with an agency or attorney

1. In the **Account** toolbar, click **AIM Place**.

AIM Placement

Which Agency/Attorney...: Agency or attorney to place the account with.

Fee Schedule: If selected, specify the fee schedule to use when applying commissions.

Commission Percentage: If selected, specify the commission percentage to use when applying commissions.

Change Desk After Placement: Desk to assign to the account after it's placed with the agency or attorney. If you don't want to change the desk assignment, leave this list box blank.

Auto Recall: If selected, the system generates pending and final recall files automatically. If cleared and you want to recall the account, do the steps to [Recall an Account From an Agency or Attorney](#) to recall the account manually.

Pending Recall in Days: Date to generate the pending recall file automatically. When you specify a date, the system calculates the number of days between the current date and the pending recall date.

Final Recall After Pending in Days: Date to generate the final recall file automatically. When you specify a date, the system calculates the number of days between the pending and final recall dates.

Change Desk After Auto Recall: Desk to assign to the account after it's recalled automatically from the agency or attorney.

- Complete the information and then click **OK**. The **AIM Place** menu option becomes unavailable to indicate that the account placement is pending. When a user generates placement files for the agency or attorney using the AIM program, AIM includes the account in the file. Latitude then displays the [AIM Card](#).

Recall an Account From an Agency or Attorney

Use the **AIM Recall** dialog box to flag for recall an account that your organization placed with an outside collection agency or attorney. If the system already flagged the account for automatic recall, doing this step isn't necessary.

Notes:

- If the AIM Recall menu option is visible and available, the account is available for recall from an outside agency or attorney.
- If the AIM Recall menu option is visible but not available, the account is pending recall from an outside agency or attorney. A pending recall occurs when a user recalls an account manually or when the automatic recall date has passed.

To recall an account from an agency or attorney

1. In the **Account** toolbar, click **AIM Recall**.

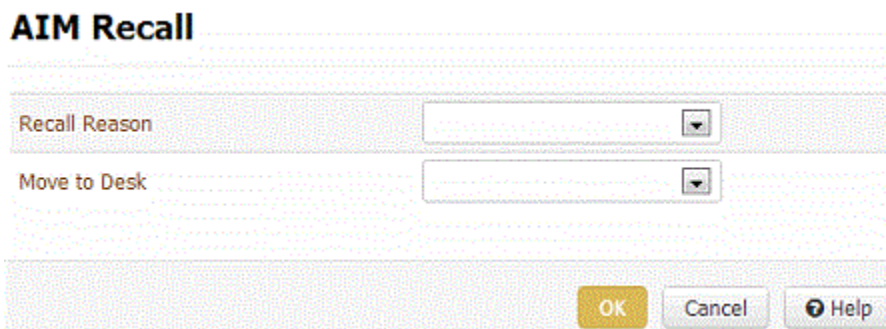

The screenshot shows the 'AIM Recall' dialog box. It has a title bar with the text 'AIM Recall'. Below the title bar, there are two dropdown menus. The first is labeled 'Recall Reason' and the second is labeled 'Move to Desk'. At the bottom right of the dialog, there are three buttons: 'OK' (yellow), 'Cancel', and 'Help' (with an information icon).

Recall Reason: Reason that you are recalling the account from the outside collection agency or attorney.

Move to Desk: Desk to assign to the account when the system generates the recall file. If you don't want to change the desk assignment, leave this list box blank.

2. Complete the information and then click **OK**. The **AIM Recall** menu option becomes unavailable to indicate that the account recall is pending. When a user generates recall files for the agency or attorney using the AIM program, AIM includes the account in the file. Latitude removes the [AIM Card](#).

Manage Interest

Use the **Manage Interest** dialog box to start or stop client-level interest for the account. You must have the Allow Start/Stop Interest Permission and your organization must have configured interest at the client level. For more information, see Client Interest.

To manage interest

1. In the **Account** toolbar, click **Interest**.

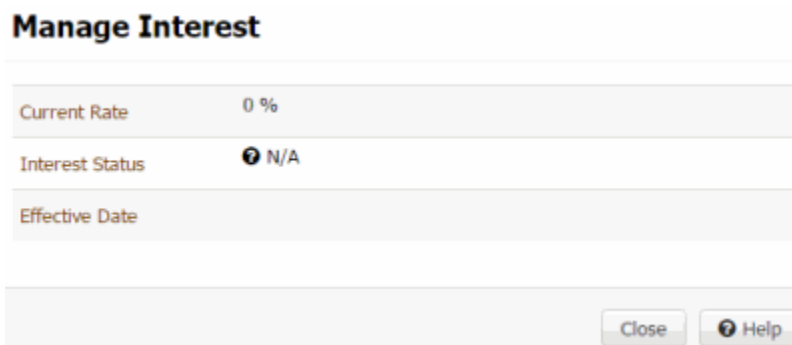

Manage Interest	
Current Rate	0 %
Interest Status	 N/A
Effective Date	

Close  Help

Current Rate: Current interest rate. If you set a rate at the account level, the system displays that rate. If you didn't set a rate at the account level, the system displays the customer rate unless one doesn't exist. If no rate exists, this box displays "0%".

Interest Status: Indicates whether the account-level interest has started or stopped. If you didn't set a rate at the account level, this box displays "N/A".

Effective Date: Date the interest rate took effect. If no rate exists, this box is blank.

2. Do one of the following:
 - To start client-level interest on the account, click **Start**.
 - To stop client-level interest on the account, click **Stop**.

Collection Holds

Collection Holds

You can place collection holds at the account level or customer level to suspend outbound collection activity for a specific number of days. Holds do not prevent inbound activity. Holds don't suspend communication templates that your organization flagged to ignore holds.

Account-level hold

An account-level hold suspends activity for all parties on a specific account. Collection activity continues on other accounts for which the parties are responsible. An account-level hold:

- Suspends outbound collection activity on the account.
- Suspends outbound letters, email messages, and SMS communications to parties on the account.
- Excludes the account from dialer campaigns. Users can still click to dial calls and dial calls manually.
- Excludes the account from work queues.
- Suspends interest accrual for the account.

Customer-level hold

A customer-level hold suspends activity for a specific party on the specific account only. Collection activity continues for other parties on the account. Collection activity also continues on other accounts for which the party is responsible. A customer-level hold:

- Suspends outbound collection activity on the account for the specific party.
- Suspends outbound letters, email messages, and SMS communications to the specific party on the account.

Place an Account-Level Hold

Use the **Manage Holds** dialog box to place a collection hold at the account-level. You must have the Allow Creation of Holds Permission.

To place an account-level hold

1. In the **Account** toolbar, click **Holds**.
2. In the **Options** list box, click **Account**.

Manage Holds

Options:

Hold Days:

Reason:

Place Account Hold Close Help

Hold Days: Number of days to place the account on hold.

Reason: Reason for placing an account-level hold on the account.

- Complete the information and then click **Place Account Hold**. The system displays a message on the [Account Status Card](#) to indicate an account hold.

Place a Customer-Level Hold

Use the **Manage Holds** dialog box to place a collection hold at the customer-level. You must have the Allow Creation of Holds Permission.

To place a customer-level hold

- In the **Account** toolbar, click **Holds**.
- In the **Options** list box, click **Customer**.

Manage Holds

Options:

Hold Days:

Reason:

Place Customer Hold Close Help

Hold Days: Number of days to place the account on hold.

Reason: Reason for placing a customer-level hold on the account.

- Complete the information and then click **Place Customer Hold**. The system displays a message on the [Account Navigator card](#) to indicate a collection hold.

Remove an Account-Level Hold

Use the **Manage Holds** dialog box to remove an account-level collection hold. Latitude removes holds automatically on the expiration date. You must have the Allow Creation of Holds Permission.

To remove an account-level hold

- In the **Account** toolbar, click **Holds**.
- In the **Options** list box, click **Account**.

Manage Holds

The screenshot shows a dialog box titled "Manage Holds". It contains three input fields: "Options:" with the value "Account", "Expiration Date:" with the value "8/14/14", and "Reason:" with the value "test". At the bottom right, there are three buttons: "Remove Account Hold" (highlighted in yellow), "Close", and "Help".

3. Click **Remove Account Hold**.

Remove a Customer-Level Hold

Use the **Manage Holds** dialog box to remove a customer-level collection hold. Latitude removes holds automatically on the expiration date. You must have the Allow Creation of Holds Permission.

To remove a customer-level hold

1. In the **Account** toolbar, click **Holds**.
2. In the **Options** list box, click **Customer**.

Manage Holds

The screenshot shows a dialog box titled "Manage Holds". It contains three input fields: "Options:" with the value "Contact", "Expiration Date:" with the value "9/4/14", and "Reason:" with the value "Test". At the bottom right, there are three buttons: "Remove Contact Hold" (highlighted in yellow), "Close", and "Help".

3. Click **Remove Customer Hold**.

Task Panels

Task Panels

The **Task** panels allow you to maintain information for the account. This section contains a **Task Panel** navigation tree, which allows you to open the panels. The panels available to you are based on how your organization configured the Task Panels Permission.

Customers

Customers

The **Customer** panel displays information for the parties associated to the account. There is a link for each party associated to the account. When you click a party, the contact information for that party appears. Several tabs are available to allow you to view more information for the selected party, such as employer and spouse information.

Contact Information

Contact Information

The **Contact Information** tab displays information for a party on the account. Latitude uses information for the current responsible party when generating items such as letters and credit reports.

Maintain Contact Information

Use the **Contact Information** tab to maintain contact information for a party on the account.

To maintain contact information

1. In the **Task Panel** navigation tree, click **Customer** and then click a name.

The screenshot shows a web application interface for maintaining contact information. On the left is a navigation tree with categories like Arrangements, Care and Financial Hardship, Complaints, Customer (selected), Disputes, Legal - New Court Case, Letters, and Payments. The main area has tabs for Contact Information, Employer, Spouse Information, Attorney, Bankruptcy, Deceased, Assets, and CCCS. The Contact Information tab is active, displaying a form for Leslie E. Zellers Jr. The form includes fields for Prefix (None), First Name (Leslie), Last Name (Zellers), Middle Name (E), Suffix (Jr), Gender (None), AKA Name, Is Business (checkbox), Business Name, Preferred Contact Method (Unknown), and a table for phone numbers with columns for Type, Number, Attempts, Consent, and Status. The address is 44786 256TH ST, ALLENTOWN, PA 18101. Other fields include Relation to Account (DEBTOR), Is Responsible (checked), Authorized (None), National Id (165449945), Date Of Birth (9/10/1952), Drivers License, Language (None), Time Zone (Eastern), and Observes DST (checked). At the bottom are Add, Save, and Help buttons.

Column 1

Prefix: Person's name prefix.

First Name: Person's first name.

Last Name: Person's last name.

Middle Name: Person's middle name.

Suffix: Person's name suffix.

Note: To modify a party's name, you must have the Update Name Permission.

Gender: Person's gender.

AKA Name: Other name the person uses. To modify a party's AKA name, you must have the Update Name Alias Permission.

Is Business: If selected, the account is a business account. If the **Prefix, First Name, Last Name, Middle Name,** or **Suffix** boxes contain data, the system clears them.

Business Name: Name of the business. Required if **Is Business** is selected.

Preferred Contact Method: Person's preferred method of contact (for example, email, letter, text, or phone).

Column 2

Type: Type of phone number (for example, home, work, cell).

Number: Person's phone number. This box can include the phone extension. If a call is on hold, a Hold icon and a message appear next to the phone number. If the person has multiple phone numbers of the same type (for example, home), the system displays only one phone number for each type. To view all the phone numbers, see [View Phone Numbers for an Account](#).

Attempts: Number of attempts to contact the person at the corresponding phone number, either by direct dial or the Dialer.

Consent: Icons that represent the permissions the person granted for calling the corresponding phone number. For more information, see [Phone Usage Consent Icons](#).

Status: Icons that represent the status of the phone number. For more information, see [Phone Number Status Icons](#).

Email: Person's email address. To view or modify email addresses, see [Email Addresses](#).

Address: Person's street address, city, state, postal code, county, and country. To add or modify an address, see [Addresses](#).

Good/Bad/No Address: Indicates whether the address is good, bad, or blank. The label changes based on the condition of the address. If the label reads "Good," the address is good. If the label reads "Bad," the address is bad. If the label reads "No Address," all address components are blank.

Column 3

Relation to Account: Person's relation to the account. For example, the person is the primary responsible party on the account.

Is Responsible: If selected, the person is responsible for the account. For the primary party on the account, the system selects the check box and you cannot clear it. To add responsibility, you must have the Update Responsibility - Add Permission. To remove responsibility, you must have the Update Responsibility - Remove Permission.

Authorized: Person for whom the party is authorized to discuss the debt and pay on the account. For the primary party on the account, the system selects **None** and you cannot clear it.

Note: If you change the party's authorization to **None**, the system does the following:

- Removes the party's address, phone, and email address from the respective reference panels.
- Prevents the dialer from initiating calls to the party.
- Prevents users from requesting letters for the party. The system still processes pending letter requests unless you delete them before the due date.
- If there is an active arrangement on the account, the system prevents you from changing the authorization to **None** until you delete the arrangement.
- Retains previous payments, interactions, events, and notes for historical purposes.

National ID: Unique number the government issues to identify a person (for example, social security number).

Date of Birth: Contact person's date of birth.

Drivers License: Contact person's driver's license number.

Language: Contact person's preferred language.

Time Zone: Time zone associated to the contact person's address.

Observes DST: If selected, the system observes daylight savings time for the contact person's location.

2. Modify the information and then click **Save**.

Add a Party to an Account

Use the **New Customer** dialog box to add a party to the account.

To add a party to an account

1. In the **Task Panel** navigation tree, click **Customer**.

2. Click the **Contact Information** tab and then click **Add**.

New Customer

Prefix: None

First Name: Required *

Last Name: Required *

Middle Name:

Suffix: None

Gender: None

AKA Name:

Is Business:

Business Name: Required

Relation to Account: DEBTOR

Is Responsible: No

Authorized: Davis, Willie

Authorized For All Accounts

Save Close Help

Prefix: Person's name prefix.

First Name: Person's first name.

Last Name: Person's last name.

Middle Name: Person's middle name.

Suffix: Person's name suffix.

Gender: Person's gender.

AKA Name: Another name the person uses.

Is Business: If selected, the party is a business rather than an individual.

Business Name: Name of the business. Required if you selected **Is Business**.

Relation to Account: Person's relation to the account. For example, the person is the primary responsible party on the account.

Is Responsible: If selected, the person is responsible for the account. For the primary party on the account, the system selects the check box and you cannot clear it.

Authorized: Person for whom the party is authorized to discuss the debt and pay on the account. This box is available when you select **No** in the **Is Responsible** box.

Authorized For All Accounts: If selected, the party is authorized to discuss the debts and pay on all the person's accounts. This check box is available when you select a name in the **Authorized** box.

3. Complete the information and then click **Save**.

Flag an Account Address

Use the **Contact Information** tab to indicate that an address is good or bad for a party on the account.

To flag an account address

1. In the **Task Panel** navigation tree, click **Customer** and then click a name.

Type	Number	Attempts	Consent	Status
Work	5555555555	0	<input type="checkbox"/>	<input checked="" type="checkbox"/>
Home	(610) 559-9633	0	<input checked="" type="checkbox"/>	<input checked="" type="checkbox"/>

Good/Bad: Indicates whether the address is good or bad. The label changes based on the condition of the address.

2. Do the following:
 - To change a "good" address to "bad," click **Good**.
 - To change a "bad" address to "good," click **Bad**.
3. Click **Save**.

Add a Phone Number to an Account

Use the **Add Phone Number** dialog box to add a party's phone number to the account. To add a phone number, you must have the Create Phone Numbers Permission.

To add a phone number to an account

1. Do one of the following:
 - In the **Task Panel** navigation tree, click **Customer** and then click a name. In the **Contact Information** tab, click **Add Phone**.
 - In the **Reference Panel** navigation bar, click **Available Panels** and then click **Phones**. In the **Phones** toolbar, click **Add Phone**.

The **Add Phone Number** dialog box appears.

Add Phone Number

The screenshot shows a web form titled "Add Phone Number". The form contains the following fields and controls:

- Phone Number:** A text input field with a dropdown menu showing a flag icon and the text "Required".
- Phone Extension:** A text input field.
- Type:** A dropdown menu with the text "-- Choose Type - Required --".
- Status:** A dropdown menu with the text "-- Choose Status --".
- Customer on Account:** A dropdown menu with the text "-- Choose Customer - Required --".
- Name:** A text input field.
- On Hold:** A checkbox.
- Hold Expiration Date:** A date picker field with a calendar icon.
- Consent To Call:** A checkbox with the text "Granted".
- Consent To Auto Dial:** A checkbox with the text "Granted".
- Consent To SMS:** A checkbox with the text "Granted".
- Consent To FAX:** A checkbox with the text "Granted".
- Obtained From:** A dropdown menu with the text "-- Choose Obtained From - Required --".

At the bottom of the form are three buttons: "Save" (yellow), "Cancel", and "Help" (with a question mark icon).

Phone Number: Person's phone number, including the country code. You can select the country from the list box or type a plus sign (+) and then the country code (for example, "+44" for United Kingdom).

Phone Extension: Phone extension.

Type: Type of phone number.

Status: Status of the phone number.

Customer on Account: Customer on the account.

Name: Name of the person associated to the phone number.

On Hold: If selected, the phone number is on hold.

Hold Expiration Date: Date the hold expires. If you don't specify a date, the hold remains until you clear the **On Hold** check box or remove the hold using another process.

Consent To Call: If selected, the person granted permission to call this phone number.

Consent To Auto Dial: If selected, the person granted permission to call this phone number using a dialer campaign.

Consent To SMS: If selected, the person granted permission to send a text message to this phone number.

Consent to fax: If selected, the person granted permission to send a fax to this phone number.

Obtained From: Person who granted or denied permission to contact this phone number.

Method: Indicates whether the person granted permission verbally or in writing.

Comment: More information regarding the phone number.

2. Complete the information and then click **Save**.

Modify a Phone Number on an Account

Use the **Edit Phone Number** dialog box to modify phone information for a party on the account. To modify phone numbers, you must have the Update Phone Numbers Permission. To modify phone consent options, you must have the Change Phone Consent Permission. The system records phone number changes in the **Notes** panel.

Note: If the system administrator configured the Mask Phone Numbers Permission, the system replaces all or parts of the phone number with asterisks (*), depending on the configuration.

To modify a phone number on an account

1. Do one of the following:
 - In the **Task Panel** navigation tree, click **Customer** and then click a name. The **Contact Information** tab appears.

- In the **Reference Panel** navigation bar, click **Available Panels** and then click **Phones**. The **Phones** panel appears.

Number	Type	Consent	Status	Customer	Attempts	Last Attempt	Name	On Hold	Hold Expiration Date
(610) 557-8455 (On Hold)				Dugan, Susan	0				4/22/15

2. Click the arrow next to the phone number and then click **Edit**.

Edit Phone Number

Phone Number	+16105587744
Phone Extension	0
Type	Home
Status	Good
Customer on Account	Eva M Severino
Name	
On Hold	<input type="checkbox"/>
Hold Expiration Date:	<input type="text"/>
Consent To Call	<input checked="" type="checkbox"/> Granted
Consent To Auto Dial	<input checked="" type="checkbox"/> Granted
Consent To SMS	<input checked="" type="checkbox"/> Granted
Consent To FAX	<input checked="" type="checkbox"/> Granted
Obtained From	-- Choose Obtained From - Required --
Method	<input type="radio"/> Written <input checked="" type="radio"/> Verbal

Save Cancel Help

Phone Number: Person's phone number, including the country code. You can select the country from the list box or type a plus sign (+) and then the country code (for example, "+44" for United Kingdom). You cannot modify the phone number.

Phone Extension: Phone extension. You cannot modify the phone extension.

Type: Type of phone number. To modify the phone type, you must have the Update Phone Type Permission.

Status: Status of the phone number. To modify the phone status, you must have the Update Phone Status Permission.

Customer on Account: Customer on the account.

Name: Name of the person associated to the phone number.

On Hold: If selected, the phone number is on hold.

Hold Expiration Date: Date the hold expires. If you don't specify a date, the hold remains until you clear the **On Hold** check box or remove the hold using another process.

Consent To Call: If selected, the person granted permission to call this phone number.

Consent To Auto Dial: If selected, the person granted permission to call this phone number using a dialer campaign.

Consent To SMS: If selected, the person granted permission to send a text message to this phone number.

Consent to fax: If selected, the person granted permission to send a fax to this phone number.

Obtained From: Person who granted or denied permission to contact this phone number.

Method: Indicates whether the person granted permission verbally or in writing.

Comment: More information regarding the phone number.

3. Modify the information and then click **Save**.

Change the Status of an Account Phone Number

Use the **Contact Information** tab or the **Phones** panel to change the status of a phone number on the account. You must have the Update Phone Status Permission.

To change the status of an account phone number

1. Do one of the following:
 - In the **Task Panel** navigation tree, click **Customer** and then click a name. The **Contact Information** tab appears.

The screenshot shows a 'Contact Information' form with the following details:

- Prefix:** None
- First Name:** Leslie
- Last Name:** Zellers
- Middle Name:** E
- Suffix:** Jr
- Gender:** None
- AKA Name:** (empty)
- Is Business:** (unchecked)
- Business Name:** (empty)
- Preferred Contact Method:** Unknown
- Address:** 44786 256TH ST, ALLENTOWN, PA, 18101
- Phone Numbers:**
 - Work: 5555555555 (Attempts: 0, Consent: Good, Status: Good)
 - Home: (610) 558-9633 (Attempts: 0, Consent: Bad, Status: Good)
- Other Fields:** Relation to Account: DEBTOR, Is Responsible: (checked), Authorized: None, National Id: 165449945, Date Of Birth: 9/10/1952, Drivers License: (empty), Language: None, Time Zone: Eastern, Observes DST: (checked)

- In the **Reference Panel** navigation bar, click **Available Panels** and then click **Phones**. The **Phones** panel appears.

Number	Type	Consent	Status	Customer	Attempts	Last Attempt	Name	On Hold	Hold Expiration Date
(610) 557-8455 (On Hold)			⊙	Dugan, Susan	0			⚠	4/22/15

2. Click the arrow next to the phone number and then click the status (**Good** or **Bad**).

Dial a Phone Number

Use the **Contact Information** tab or the **Phones** panel to dial a phone number on the account. You can dial a phone number directly under the following conditions:

- Dialer is present.
- User is not on a call currently through manual or campaign dialing.
- **Consent To Call** option is selected, indicating that the person granted permission to call the phone number.
- Phone status is "Good."

To dial a phone number

1. Do one of the following:

- In the **Task Panel** navigation tree, click **Customer** and then click a name. The **Contact Information** tab appears.

- In the **Reference Panel** navigation bar, click **Available Panels** and then click **Phones**. The **Phones** panel appears.

Number	Type	Consent	Status	Customer	Attempts	Last Attempt	Name	On Hold	Hold Expiration Date
(610) 557-8455 (On Hold)				Dugan, Susan	0				4/22/15

2. Click the arrow next to the phone number and then click **Dial Number**. If the conditions for dialing a phone number are met, Latitude places the call.

Add a Phone Contact Result

Use the **Contact Information** tab or the **Phones** panel to add the result of contacting a party on the account. The system records these changes in the **Notes** panel.

To add a phone contact result

1. Do one of the following:
 - In the **Task Panel** navigation tree, click **Customer** and then click a name. The **Contact Information** tab appears.





- In the **Reference Panel** navigation bar, click **Available Panels** and then click **Phones**. The **Phones** panel appears.

Number	Type	Consent	Status	Customer	Attempts	Last Attempt	Name	On Hold	Hold Expiration Date
 (610) 557-8455 (On Hold)				Dugan, Susan	0				4/22/15

- Click the arrow next to the phone number and then click the contact result. For example, No Answer, Line Busy, Bad Number, Left Message Person, and Left Message Machine.





Phone Number Status Icons

The status indicates the state of an account phone number. The following table lists the phone number status icons and their description.

Icon	Description
	The status of the phone number is unknown.
	The phone number is bad.
	The phone number is good.
	The phone number is on hold.

Phone Usage Consent Icons

Phone Usage Consent icons represent the permissions the customer granted or denied for a phone number. The following table lists the phone usage consent icons and their description. A green icon indicates that the customer granted permission and a red icon indicates that the customer denied permission.

Icon	Description
	Indicates whether the customer granted permission to call this phone number.
	Indicates whether the customer granted permission to call this phone number using a dialer.
	Indicates whether the customer granted permission to fax this phone number.
	Indicates whether the customer granted permission to text this phone number.

Maintain Employer Information

Use the **Employer** tab to maintain employment information for a party on the account.

To maintain employer information

- In the **Task Panel** navigation tree, click **Customer** and then click a name.
- Click the **Employer** tab.

Name: Name of customer's employer.

Address: Employer's street address, city, state, postal code, county, and country.

Verified: If selected, you verified the employer's information. If you change any of the employer's information, the system clears the check box and you have to reverify the information.

Comment: Comments regarding the person's employer.

3. Complete the information and then click **Save**.

Maintain Spouse Information

Use the **Spouse Information** tab to maintain spousal information for a party on the account.

To maintain spouse information

1. In the **Task Panel** navigation tree, click **Customer** and then click a name.
2. Click the **Spouse Information** tab.

Name: Name of the customer's spouse.

Employer: Name of the spouse's employer.

Address: Spouse's employer's street address, city, state, postal code, county, and country.

Comment: Comments regarding the spouse or the spouse's employer.

3. Complete the information and then click **Save**.

Maintain Attorney Information

Use the **Attorney** tab to maintain attorney information for a party on the account.

To maintain attorney information

1. In the **Task Panel** navigation tree, click **Customer** and then click a name.
2. Click the **Attorney** tab.

The screenshot shows a web-based form for maintaining attorney information. The form is titled 'Attorney' and is part of a navigation menu that includes 'Contact Information', 'Employer', 'Spouse Information', 'Attorney', 'Bankruptcy', 'Deceased', 'Assets', and 'CCCS'. The form fields are: Name, Firm, Address (Street Line 1, Street Line 2, City, State, Postal Code, County, Country), Phone, Email, Fax, and Comment. At the bottom of the form are buttons for 'Save', 'Delete', and 'Help'.

Name: Name of the attorney.

Firm: Name of the attorney's legal firm.

Address: Attorney's street address, city, state, postal code, county, and country.

Phone: Attorney's phone number.

Email: Attorney's email address.

Fax: Attorney's fax number.

Comment: Comments regarding the attorney.

3. Do one of the following:
 - To add or modify attorney information, complete the information and then click **Save**.
 - To remove the attorney from the account, click **Delete** and then, in the confirmation dialog box, click **OK**.

Bankruptcy

Bankruptcy

Use the **Bankruptcy** tab to maintain bankruptcy information for a party on the account. The system recognizes an account as being in bankruptcy when you provide the chapter, case number, and date filed.

Maintain General Bankruptcy Information

Use the **Bankruptcy General** tab to maintain general bankruptcy information. Some information on this tab is available for use in merge letters.

To maintain general bankruptcy information

1. In the **Task Panel** navigation tree, click **Customers** and then click a name.
2. Click the **Bankruptcy** tab and then click the **Bankruptcy General** tab.

Chapter: Bankruptcy chapter number. The information available on the **Bankruptcy General** tab is based on the bankruptcy chapter selected.

Converted Chapter: If the customer filed bankruptcy under a different chapter originally, the original bankruptcy chapter number.

Case Number: Case number the court assigned to the bankruptcy.

Date Filed: Date the customer filed the case with the bankruptcy court.

Status: Status of the bankruptcy.

Notice Received: Date the client received a notice that the customer filed for bankruptcy.

Proof of Claim: Date the client sent a proof of claim to the court.

Creditor Meeting: Date and time of the creditor meeting.

Confirm Hearing: Date the court set the confirmation hearing.

Discharge Date: Date the court discharged the bankruptcy.

Dismissal Date: Date the court dismissed the bankruptcy.

Has Asset: If selected, indicates that the customer has assets to secure the debt. This check box displays for chapter 7 only.

Method: Method through which the court discharges account. This list box displays for chapter 7 only. Valid values are:

None: Customer didn't specify a method.

No Intention to Reaffirm: Customer or the customer's attorney didn't file.

Reaffirmation: Customer reaffirmed the debt under new terms. The following boxes appear when you select this option:

- **Reaffirmation Amount:** Amount that the customer reaffirmed to pay.

- **Reaffirmation Filed Date:** Date the customer filed the reaffirmation with the court.
- **Reaffirmation Terms:** Agreed upon terms of the reaffirmation.

Surrender: Customer chose to surrender collateral. The following boxes appear when you select this option:

- **Surrender Date:** Date the customer surrendered the item.
- **Surrender Method:** Indicates how the customer surrendered the item (for example, shipped or picked up).
- **Auction House:** Name of the auction house that auctioned the surrendered item.
- **Auction Date:** Date the auction house auctioned the surrendered item.
- **Auction Amount:** Amount the auction house received for the surrendered item.
- **Auction Fee:** Fee the auction house charged for auctioning the surrendered item.
- **Auction Amount Applied:** Amount of the auction funds applied to the account.

Voluntary: Customer chose to pay off the debt voluntarily, possibly under new terms, without officially filing through the court. The following boxes appear when you select this option:

- **Voluntary Date:** Date the customer volunteered to pay off the debt.
- **Voluntary Amount:** Amount the customer volunteered to pay.
- **Terms:** Terms of the voluntary payment agreement.

Claim Type: Indicates whether the debt is secured, unsecured, or split. This list box displays for chapters 11, 12, and 13 only.

Secured Amount: Amount of the debt that is secured. This box displays for chapters 11, 12, and 13 only.

Unsecured Amount: Amount of the debt that is unsecured. This box displays for chapters 11, 12, and 13 only.

Secured Plan Percent: Percentage of the secured amount for which the customer remains responsible. This box displays for chapters 11, 12, and 13 only.

Unsecured Plan Percent: Percentage of the unsecured amount for which the customer remains responsible. This box displays for chapters 11, 12, and 13 only.

3. Complete the information and then click **Save**.
4. To delete the information, click **Delete**.

Maintain Court Information

Use the **Bankruptcy Court** tab to maintain court information. Some information on this tab is available for use in merge letters.

To maintain court information

1. In the **Task Panel** navigation tree, click **Customers** and then click a name.

2. Click the **Bankruptcy** tab and then click the **Bankruptcy Court** tab.

District: Court district.

Division: Court division.

Address: Court's street address, city, state, postal code, county, and country.

Court Phone: Court phone number.

3. Complete the information and then click **Save**.
4. To delete the information, click **Delete**.

Maintain Trustee Information

Use the **Bankruptcy Trustee** tab to maintain trustee information. Some information on this tab is available for use in merge letters.

To maintain trustee information

1. In the **Task Panel** navigation tree, click **Customers** and then click a name.
2. Click the **Bankruptcy** tab and then click the **Bankruptcy Trustee** tab.

Name: Trustee's name.

Address: Trustee's street address, city, state, postal code, county, and country.

Trustee Phone: Trustee's phone number.

Is Scheduled: If selected, the court scheduled a creditor meeting.

Creditor Meeting: Date and time of the creditor meeting.

Location: Location of the creditor meeting.

3. Complete the information and then click **Save**.
4. To delete the information, click **Delete**.

Maintain Bankruptcy Comments

Use the **Bankruptcy Comments** tab to maintain bankruptcy comments. Information on this tab is not available for use in merge letters.

To maintain bankruptcy comments

1. In the **Task Panel** navigation tree, click **Customers** and then click a name.
2. Click the **Bankruptcy** tab and then click the **Bankruptcy Comments** tab.

The screenshot shows a software interface with a navigation tree on the left and a main content area. The navigation tree includes: Arrangements, Care and Financial Hardship, Complaints, Customer (expanded to show Tammy Bernard), Disputes, Legal - New Court Case, and Letters. The main content area has a top navigation bar with tabs: Contact Information, Employer, Spouse Information, Attorney, Bankruptcy, Deceased, Assets, CCCS, and Restrictions. Below this, there are sub-tabs for Bankruptcy: Bankruptcy General, Bankruptcy Court, Bankruptcy Trustee, and Bankruptcy Comments. The Bankruptcy Comments tab is active, showing a 'Comment:' label and a large empty text box. At the bottom of the main content area, there are three buttons: Save, Delete, and Help.

3. In the **Comment** box, type a comment and then click **Save**.
4. To delete the comments, click **Delete**.

Maintain Deceased Information

Use the **Deceased** tab to maintain information regarding a deceased party on the account. If your organization installed an import interface, the system imports information into this panel. Otherwise, you can add the information manually. For deceased permissions, see the Deceased Permission.

To maintain deceased information

1. In the **Task Panel** navigation tree, click **Customer** and then click a name.
2. Click the **Deceased** tab.

Latitude Printable Help

The screenshot shows the 'Deceased' tab in the Latitude software. The interface is organized into several sections for data entry:

- State:** A dropdown menu.
- Postal Code:** A text input field.
- Birth:** A date input field with a calendar icon, showing '09/26/1975'.
- Death:** A date input field with a calendar icon and the label 'Required'.
- Claim Deadline:** A date input field with a calendar icon.
- Date Filed:** A date input field with a calendar icon.
- Case Number:** A text input field.
- Executor of Estate:** Fields for Name, Address (Street Line 1, Street Line 2, City), State, Postal Code, County, and Country, along with Phone and Fax.
- Court:** Fields for District, Division, Address (Street Line 1, Street Line 2, City), State, Postal Code, County, and Country, along with Phone.

At the bottom of the form, there are three buttons: 'Save' (orange), 'Delete' (grey), and 'Help' (grey with a question mark icon).

State: State where the customer's death occurred.

Postal Code: Postal code (for example, postal code) where the customer's death occurred.

Birth: Customer's date of birth.

Death: Customer's date of death.

Claim Deadline: Deadline for filing a claim against the customer's estate.

Date Filed: Date the client filed a claim against the customer's estate.

Case Number: Claim case number.

Executor of Estate

Name: Name of the executor of the customer's estate.

Address: Executor's street address, city, state, postal code, county, and country.

Phone: Executor's phone number.

Fax: Executor's fax number.

Court

District: Court district handling the customer's estate.

Division: Court division handling the customer's estate.

Address: Court's street address, city, state, postal code, county, and country.

Phone: Court's phone number.

3. Complete the information and then click **Save**.

Maintain Assets

Use the **Assets** tab to maintain assets for a party on the account.

To maintain assets

1. In the **Task Panel** navigation tree, click **Customer** and then click a name.

- Click the **Assets** tab.

Asset Name / Title	Asset Type	Current Value	Lien Amount	Description	
2011 Chevy Equinox	AUTO	20000 ✓	10000 ✓	Great condition	Edit Delete
2006 Harley_Davidson	AUTO	8000 ✓	0	Excellent condition	Edit Delete

Asset Name/Title: Name or description of the asset.

Asset Type: Type of asset.

Current Value: Current value of the asset.

Is Verified: A green check mark indicates that you verified the asset value. A red "x" indicates that you didn't verify the asset value.

Lien Amount: Amount held against the asset.

Is Verified: A green check mark indicates that you verified the lien amount. A red "x" indicates that you didn't verify the lien amount.

Description: More information regarding the asset.

- To add an asset, click **Add**, complete the information, and then click **Save**.
- To modify an asset, click **Edit**, modify the information, and then click **Save**.
- To delete an asset, click **Delete** and then, in the confirmation dialog box, click **OK**.

Maintain CCCS Information

Use the **CCCS** tab to maintain Consumer Credit Counseling Service (CCCS) information for a party on the account. CCCS is an entity that a person engages to negotiate settlement or payment arrangements on a debt.

To maintain CCCS information

- In the **Task Panel** navigation tree, click **Customer** and then click a name.
- Click the **CCCS** tab.

Contact Information	Employer	Spouse Information	Attorney	Bankruptcy	Deceased	Assets	CCCS
Customer Dugan, Susan Sampson, Sam Legal - 1234 Letters Payments	Company: <input type="text" value="Required"/> * Contact: <input type="text"/> Address: <input type="text" value="Street Line 1"/> <input type="text" value="Street Line 2"/> City State Postal Code Country Country	Phone: <input type="text"/> Fax: <input type="text"/> Client ID: <input type="text"/> Creditor ID: <input type="text"/> Date Accepted: <input type="text"/> <input type="button" value="📅"/> Amount Accepted: \$ <input type="text"/>	Comment: <input type="text"/>				
<input type="button" value="Save"/> <input type="button" value="Delete"/> <input type="button" value="Help"/>							

Company: Name of the customer's CCCS company.

Contact: Name of the customer's CCCS counselor.

Address: CCCS counselor's street address, city, state, postal code, county, and country.

Phone: CCCS counselor's phone number.

Fax: CCCS counselor's fax number.

Client ID: Code that CCCS assigned to identify the customer.

Creditor ID: Code that CCCS assigned to identify the collection agency.

Date Accepted: Date the CCCS counselor accepted the filing.



Amount Accepted: Amount of the debt the customer is to pay.

Comment: Comments regarding the CCCS arrangement.

3. Complete the information and then click **Save**.
4. To delete the information, click **Delete** and then, in the confirmation dialog box, click **Yes**.

Customer Icons

The following table lists the customer icons and their description. When applicable, these icons appear next to the customer's name under the Customers heading in the navigation bar.

Icon	Description
	This customer is the primary person on the account.
	This customer is responsible for the account.
	This customer has warning messages associated to the account.

Arrangements

Arrangements

Use the **Arrangements** panel to create proposed payment arrangements and convert them to scheduled arrangements for the account and any selected joined accounts. Parties only need one arrangement to cover their total liability (their joint accounts plus any individual accounts with the same client) regardless of the number of accounts. Any party on a joint account can arrange to pay the joint balance in full. The system reflects payments applied to a joined account on the balance of the linked parties' total liability.

Joined accounts

You can pursue each party on a joined account individually as all parties are responsible for the debt. The parties appear in dialing campaigns, letter campaigns, and work queues as if they had separate debts. For example, party A has joint responsibility for a debt and has an individual account. When you contact party B about the joint account, the system doesn't include the individual account for party A as part of the balance that party B owes.

A party on a joint account can offer payment to cover the liability for all parties on the account. You remove the other parties' liability to pay (but not their responsibility). If one party claims liability, you cannot contact the other parties for payment unless the primary party defaults on the arrangement. For example, if party A takes sole liability for the joint account with party B, you cannot contact party B

about the joint account. You can, however, contact party B about other individual accounts that belong to party B. If party A's arrangement fails, you reinstate liability and pursue party B. Don't apply payments to the joint account that you receive from a party relieved of their joint liability unless:

- The party relieved of liability doesn't have a sole liability account to apply the payment.
- The party solely responsible for the joint account specifically requests that you apply the payment to the joint account.
- The party relieved of liability requests that you reinstate the liability.

You can create a single arrangement to cover the joint account and any individual accounts a party owns. The system splits the payments across the joint and individual debts as follows:

- If no parties on the joint account assume sole liability, each party's contribution to the joint account (from their individual arrangement) reduces the joint liability. For example, party A arranges to pay \$100 per month and the system allocates \$20 of that amount to the joint account. Party B arranges to pay \$50 per month and the system allocates \$10 of that amount to the joint account. The balance on the joint account decreases by \$30.
- If a party on the joint account assumes sole liability, the other parties' arrangement covers their individual accounts only unless one of the other parties indicates otherwise. For example, party A assumes liability and arranges to pay \$100 per month. The system allocates \$20 of that amount to the joint account. Party B arranges to pay \$50 per month and the system allocates nothing to the joint account except at the request of party B.

SIF arrangements

Custodian determines whether a customer fulfilled a Settled in Full (SIF) arrangement when the SIF arrangement doesn't use a credit card or ACH payment method. If the customer fulfilled the SIF arrangement, Custodian changes the account status to SIF and closes the account.

Propose a Payment Arrangement

Use the **Payment Negotiator** card in the **Arrangements** panel to propose a credit card, ACH, paper draft, or promise payment arrangement for an account. You can schedule payments for the current date or future dates only.

If your organization configured the Allow Overpayments permission to allow overpayment arrangements, you can create a single payment arrangement for an amount that exceeds the account balance but doesn't exceed the maximum overpayment amount allowed.

To propose a payment arrangement

1. In the **Task Panel** navigation tree, click **Arrangements**.

The screenshot displays two main sections: 'Joined Accounts' and 'Payment Negotiator'.

Joined Accounts: Includes a 'Total' button, a 'Select/Deselect All Active' checkbox, and a list of accounts. The first account is checked and labeled 'NEW', with details '(1205) 30099888777'. A second account is unchecked and also labeled 'NEW', with details '(1003) 30032419801'.

Payment Negotiator: Contains various input fields and buttons:

- Method:** A dropdown menu with 'Select a payment ...' and a plus sign.
- Start Date:** A date field set to '10/9/2019'.
- Amount:** A field with '\$ 250' and an 'ON' indicator.
- First Amount:** A field with '\$'.
- Frequency:** Two buttons: 'Monthly' and 'Day 9'.
- Surcharge Amount:** A field with '\$0.00'.
- # Payments:** A field with 'Will be calculated' and an 'OFF' indicator.
- Total:** A field with '\$250.00'.
- Surcharge Total:** A field with 'Will be calculated'.
- Gross Total:** A field with 'Will be calculated'.
- Negotiated:** A field with '\$250.00'.
- Overpay Mode:** A field with 'OFF'.

 At the bottom, there is a 'PIF Mode' label, a yellow 'Propose' button, and a 'Help' button with an information icon.

Joined Accounts card

If the account displayed currently is a joined account, the system displays the **Joined Accounts** card. If the account is not a joined account, the system hides this card. By default, the system selects the check box next to the account displayed currently and includes it first in the list. Then, the system lists all other accounts associated to the *customer* displayed currently. If there are closed accounts in the list, they appear in red.

Total: Refreshes the data in the **Joined Accounts** card.

Select/Deselect All Active: Selects or clears the check boxes next to each account.

[Include Account]: If selected, the system includes the account in the arrangement and in the total account balance.

Payment Negotiator card

Method: Method to use to process the payments. You can select an existing payment method or click the plus sign (+) to [add one](#). If you select "Promise," specify the payment type the party promises to use to pay. The system doesn't display expired credit cards in this list box.

Start Date: Due date for the first payment in the arrangement.

Amount: Amount of each payment. This amount defaults to a single payment for the total amount due on the account, excluding surcharges. If you set the indicator to "ON," specify the amount of each payment. If you set the indicator to "OFF," the system calculates the payment amount based on the account balance and number of payments specified, if any.

First Amount: Down payment amount. Specify an amount here when the customer wants to pay an amount on the first payment that differs from the remaining payments. For example, the customer wants to pay \$300 down and \$200 per month for the remaining balance.

Frequency: How often a payment is due on the account. If you select "Monthly," specify the day of the month the payment is due (for example, the fifth day of the month). If you select "Monthly Pick," specify the time of the month payment is due. For example, the first Friday of the month. If you select "Four Weekly," the frequency is one payment every four weeks. If you select "Daily," the system still skips weekends and holidays.

Surcharge Amount: Amount to include as a surcharge for each payment in the arrangement. If you have the appropriate permissions, an "ON" indicator appears. To remove the surcharge, set the indicator to "OFF." The system removes the surcharge amount. For more information about surcharges, see [Surcharge Rules](#).

Payments: Number of payments in the arrangement. If you set the indicator to "ON," specify the number of payments. If you set the indicator to "OFF," the system calculates the number of payments based on the account balance and payment amount.

Total: Total scheduled amount for all the payments in the arrangement, excluding surcharges. If you set the indicator to "ON," specify the total payment amount. If you set the indicator to "OFF," the system calculates the total payment amount based on the account balance, number of payments, and interest accrual amount.

Surcharge Total: Total surcharge amount for all the payments in the arrangement. If you specify the number of payments, the system calculates and displays the surcharge amount immediately. Otherwise, the system calculates it after you propose the arrangement.

Gross Total: Total payment amount, including surcharges.

Negotiated: Total payment amount negotiated, excluding any surcharges. The system calculates this amount. This box displays when the **Is Settlement** check box is cleared.

Overpay Mode: If you set the indicator to "ON," the system allows you to create a single payment arrangement for an amount that exceeds the account balance but doesn't exceed the maximum overpayment amount allowed. If you set the indicator to "OFF," the system doesn't limit the payment arrangement to a single payment only. For more information about creating an overpayment arrangement, see [Create a Payment Arrangement for an Overpayment](#).

Is Settlement: If selected, this payment arrangement settles the account in full, regardless of the account balance. If there is an existing scheduled payment ready to process in the **Scheduled Payments** card or your organization doesn't allow SIF arrangements, the system hides this check box. You cannot schedule a SIF arrangement until you process the scheduled payment.

Minimum: Percent of the account balance to pay. This box displays when the **Is Settlement** check box is selected. If you specify a percent, the system calculates the settlement amount. If the amount is below the minimum settlement amount allowed, the system places the arrangement on hold and displays a message indicating the settlement amount requires approval.

[Amount]: Amount of the account balance to pay. This box displays when the **Is Settlement** check box is selected. If you specify an amount, the system calculates the settlement percent.

Bank Account #: Eight-digit number that identifies the bank account from which to draw a Direct Debit payment. The system displays this box when the payment method is "Direct Debit."

Bank Sort: Six-digit sort code used to validate the bank account number. The system displays this box when the payment method is "Direct Debit."

2. Do one of the following:

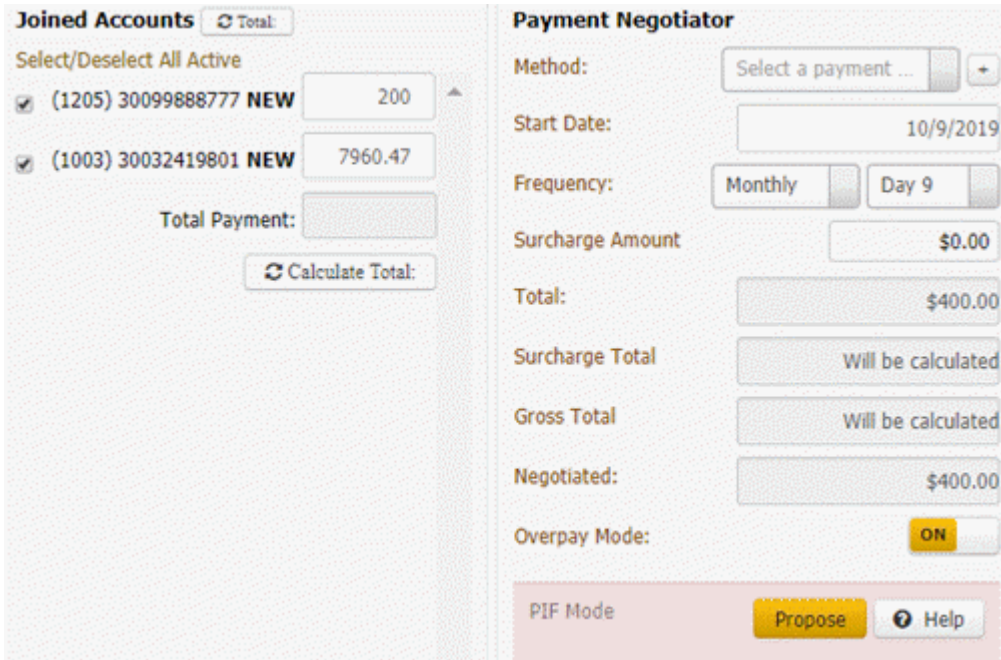
To create an arrangement for...	Do the following...
One or more accounts where the payment doesn't exceed the account balance...	<p>In the Payment Negotiator card, complete the arrangement information and then click Propose.</p>
One or more joined accounts where the payment exceeds the account balance...	<p>a. In the Payment Negotiator card, set the Overpay Mode to "On."</p>  <p>The screenshot shows the 'Payment Negotiator' card with the following details:</p> <ul style="list-style-type: none"> Method: Select a payment ... Start Date: 10/9/2019 Frequency: Monthly (selected), Day 9 Surcharge Amount: \$0.00 Total: \$400.00 Surcharge Total: Will be calculated Gross Total: Will be calculated Negotiated: \$400.00 Overpay Mode: ON (highlighted in yellow) PIF Mode: Propose (button), Help (button) <p>b. In the Joined Accounts card, do the following:</p> <ul style="list-style-type: none"> To include a joined account in the arrangement, select the check box next to the account number.

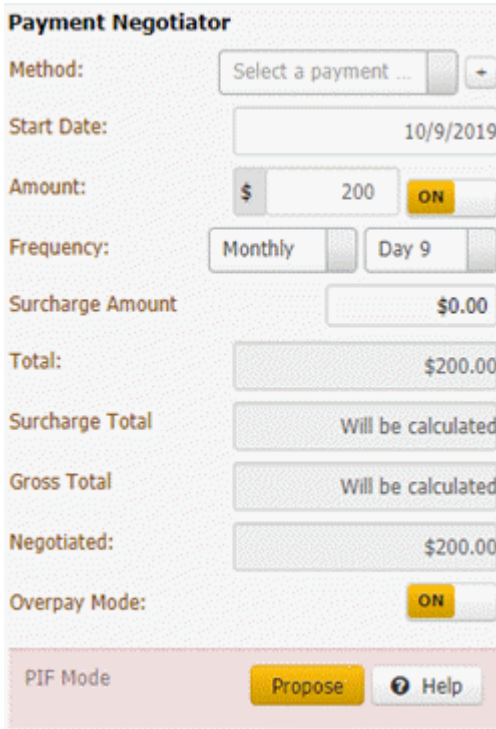
	<ul style="list-style-type: none"> • In the [Amount] box for each selected account, type the payment amount to arrange for that account. • Click Calculate Total. The system displays the total payment amount for all selected accounts in the Total Payment box. <p>c. In the Payment Negotiator card, specify the arrangement method; start date; and frequency, and then click Propose.</p> <p>Note: If the amount in the Total Payment box exceeds the overpayment amount allowed, an error message displays. In the Joined Accounts card, change the payment amount for one or more accounts so that the total payment amount doesn't exceed the overpayment limit and then click Propose.</p>
<p>A single, non-joined account where the payment exceeds the account balance...</p>	<p>a. In the Payment Negotiator card, set the Overpay Mode to "On."</p>  <p>b. Specify the method; start date; amount; and frequency, and then click Propose.</p> <p>Note: If the payment amount exceeds the overpayment amount allowed, an error message displays. Change the payment amount to an amount that doesn't exceed the overpayment limit and then click Propose.</p>

The payment arrangement appears in the **Scheduled Payments** card.

Scheduled Payments: \$400.00 Total Surcharges: \$0.00

Hold?	Date	Surcharge	Amount	Total	Method	Payer	Status
▶	Nov 2, 2016	\$0.00	\$100.00	\$100.00	Promise - CASH	Roy Wiesen	Proposed
▶	Dec 2, 2016	\$0.00	\$100.00	\$100.00	Promise - CASH	Roy Wiesen	Proposed
▶	Jan 3, 2017	\$0.00	\$100.00	\$100.00	Promise - CASH	Roy Wiesen	Proposed
▶	Feb 2, 2017	\$0.00	\$100.00	\$100.00	Promise - CASH	Roy Wiesen	Proposed

Delete All
Edit
Save

Note: If an account in the arrangement has a "closed" status, a message displays indicating that you cannot propose an arrangement on a closed account. Remove the closed account from the arrangement.

Scheduled Payments: Total scheduled payment amount, excluding surcharges.

Total Surcharges: Total surcharge amount for all the payments in the arrangement.

Hold?: Indicates whether the scheduled payment is on hold. The system doesn't process payments that are on hold.

Date: Date to process the payment.

Surcharge: Amount to include as a surcharge for the payment.

Amount: Amount of the payment, excluding surcharges.

Total: Total amount to process for the payment, including surcharges.

Method: Payment method to use (for example, credit card, ACH, paper draft, or promise).

Payer: Party on the account who arranged the payment.

Status: Status of the payment.

- In the **Scheduled Payments** card, do the following:
 - To view details for a scheduled payment in a joined account arrangement, in the data grid, click the arrow for the row to view.
 - To add payments to the arrangement, complete the information in the **Payment Negotiator** card and then click **Propose**.
 - To save the proposed arrangement, click **Save**. If the payment arrangement has a status of "proposed," the system changes it to "scheduled." If the account has at least one SIF arrangement, "Settlement in Progress" appears next to the "Scheduled Payments" heading.

- To delete all the payments in the arrangement, click **Delete All**, and in the confirmation dialog box, click **Yes**.

Modify a Payment Arrangement

Use the **Scheduled Payments** card in the **Arrangements** panel to modify a proposed or scheduled payment arrangement for an account.

To modify a payment arrangement

- In the **Task Panel** navigation tree, click **Arrangements**.

The screenshot displays the 'Payment Negotiator' interface. On the left, the 'Joined Accounts' card shows a list of accounts with checkboxes. The 'Payment Negotiator' card contains fields for Start Date (8/30/2017), Amount (Will be calculated), First Amount (\$), Frequency (Monthly, Day 28), Surcharge Amount (\$0.00), # Payments (3, ON), Total (Will be calculated), Surcharge Total (\$0.00), Gross Total (\$967.47), and Negotiated (\$967.47). On the right, the 'Scheduled Payments' card shows a table with columns: Hold?, Date, Surcharge, Amount, Total, Method, Payer, and Status. The table contains three rows of scheduled payments, all with a status of 'Proposed'.

Hold?	Date	Surcharge	Amount	Total	Method	Payer	Status
	Aug 30, 2017	\$0.00	\$322.49	\$322.49	Promise - CHECK	Richard Kile	Proposed
	Sep 28, 2017	\$0.00	\$322.49	\$322.49	Promise - CHECK	Richard Kile	Proposed
	Oct 30, 2017	\$0.00	\$322.49	\$322.49	Promise - CHECK	Richard Kile	Proposed

Joined Accounts card

If the account displayed currently is a joined account, the system displays the **Joined Accounts** card. If the account is not a joined account, the system hides this card. By default, the system selects the check box next to the account displayed currently and includes it first in the list. Then, the system lists all other accounts associated to the *customer* displayed currently. If there are closed accounts in the list, they appear in red.

Total: Refreshes the data in the **Joined Accounts** card.

Select/Deselect All Active: Selects or clears the check boxes next to each account.

[Include Account]: If selected, the system includes the account in the arrangement and in the total account balance.

Payment Negotiator card

Start Date: Due date for the first payment in the arrangement.

Amount: Amount of each payment. This amount defaults to a single payment for the total amount due on the account, excluding surcharges. If you set the indicator to "ON," specify the amount of each payment. If you set the indicator to "OFF," the system calculates the payment amount based on the account balance and number of payments.

First Amount: Down payment amount. Specify an amount here when the customer wants to pay an amount on the first payment that differs from the remaining payments. For example, the customer wants to pay \$300 down and \$200 per month for the remaining balance.

Frequency: How often a payment is due on the account. If you select "Monthly," specify the day of the month the payment is due (for example, the fifth day of the month). If you

select "Monthly Pick," specify the time of the month payment is due. For example, the first Friday of the month. If you select "Four Weekly," the frequency is one payment every four weeks. If you select "Daily," the system still skips weekends and holidays.

Surcharge Amount: Amount to include as a surcharge for each payment in the arrangement. If you have the appropriate permissions, an "ON" indicator appears. To remove the surcharge, set the indicator to "OFF." The system removes the surcharge amount. For more information about surcharges, see [Surcharge Rules](#).

Note: If you change the surcharge amount at the payment method or client fee level after creating an arrangement, the system doesn't reflect the change here unless you change the payment method.

Payments: Number of payments in the arrangement. If you set the indicator to "ON," specify the number of payments. If you set the indicator to "OFF," the system calculates the number of payments based on the account balance and payment amount.

Total: Total scheduled amount for all the payments in the arrangement, excluding surcharges. If you set the indicator to "ON," specify the total payment amount. If you set the indicator to "OFF," the system calculates the total payment amount based on the account balance, number of payments, and interest accrual amount.

Note: You cannot change the payment method in the **Payment Negotiator** until you save the proposed arrangement.

- To add payments to the arrangement, complete the information in the **Payment Negotiator** card and then click **Propose**. The payments appear in the **Scheduled Payments** card.

Note: If an account in the arrangement has a "closed" status, a message displays indicating that you cannot propose an arrangement on a closed account. Remove the closed account from the arrangement.

- To modify a payment, in the **Scheduled Payments** card, click **Edit** and then modify the following information as necessary.

Scheduled Payments: \$400.00 Total Surcharges: \$0.00

Hold?	Date	Surcharge	Amount	Total	Method	Payer	Status
<input type="checkbox"/>	11/2/2016	\$0.00 ON	100	\$100.00	Promise CASH	Roy Wiesen	Proposed
<input type="checkbox"/>	12/2/2016	\$0.00 ON	100	\$100.00	Promise CASH	Roy Wiesen	Proposed
<input type="checkbox"/>	1/3/2017	\$0.00 ON	100	\$100.00	Promise CASH	Roy Wiesen	Proposed
<input type="checkbox"/>	2/2/2017	\$0.00	100	\$100.00	Promise	Roy Wiesen	Proposed

Delete icon: Click to delete the payment.

Hold?: If selected, the system places the payment on hold and doesn't process it when the due date arrives.

Date: Date to process the payment.

Surcharge: Amount to include as a surcharge for the payment. To modify the surcharge amount, delete the arrangement and recreate it.

Amount: Payment amount, excluding surcharges.

Total: Total amount to process, including surcharges.

Method: Payment method to use to process the payment (for example, credit card, ACH, paper draft, or promise). You can select an existing payment method or click the plus sign (+) to [add one](#).

Payer: Party on the account who arranged the payment.

Status: Status of the payment. The system populates the status.

Pre Post: The system processed the payment with the vendor but hasn't posted it to the account. You cannot modify pre-post payments.

Proposed: Payment is part of a proposed payment arrangement.

Scheduled: Payment is scheduled for processing.

- When finished modifying the arrangement, click **Save**. If the payment arrangement has a status of "proposed," the system changes it to "scheduled." If the account has at least one SIF arrangement, "Settlement in Progress" appears next to the "Scheduled Payments" heading.

Tip: To delete all the payments in the arrangement, click **Delete All**, and in the confirmation dialog box, click **Yes**.

Override a Payment Spread

Use the **Override Payment Spread** dialog box to override the configured payment spread and specify the order in which to spread payments across the linked accounts in the arrangement. This option is not available for non-linked accounts. All clients in the arrangement must have the Override Payment Spread permission.

To override a payment spread

- In the **Task Panel** navigation tree, click **Arrangements**.

The screenshot displays the 'Payment Negotiator' interface. On the left, under 'Joined Accounts', three accounts are listed with checkboxes: (1000) 7738184767075 ACT (checked), (1200) 74541021574653 ACT, and (1201) 98774586630012 ACT. The main area is divided into 'Payment Negotiator' and 'Scheduled Payments' sections.

Payment Negotiator fields include: Start Date (8/30/2017), Amount (Will be calculated), First Amount (\$), Frequency (Monthly, Day 28), Surcharge Amount (\$0.00), # Payments (3), Total (Will be calculated), Surcharge Total (\$0.00), Gross Total (\$967.47), and Negotiated (\$967.47). There are 'Propose' and 'Help' buttons at the bottom.

Scheduled Payments: \$967.47 Total Surcharges: \$0.00

Hold?	Date	Surcharge	Amount	Total	Method	Payer	Status
	Aug 30, 2017	\$0.00	\$322.49	\$322.49	Promise - CHECK	Richard Kile	Proposed
	Sep 28, 2017	\$0.00	\$322.49	\$322.49	Promise - CHECK	Richard Kile	Proposed
	Oct 30, 2017	\$0.00	\$322.49	\$322.49	Promise - CHECK	Richard Kile	Proposed

At the bottom of the table area, there are 'Delete All', 'Edit', and 'Save' buttons.

- In the **Scheduled Payments** card, click **Edit**.

Scheduled Payments: \$400.00 Total Surcharges: \$0.00

Hold?	Date	Surcharge	Amount	Total	Method	Payer	Status
<input type="checkbox"/>	11/2/2016	\$0.00 ON	100	\$100.00	Promise CASH	Roy Wiesen	Proposed
<input type="checkbox"/>	12/2/2016	\$0.00 ON	100	\$100.00	Promise CASH	Roy Wiesen	Proposed
<input type="checkbox"/>	1/3/2017	\$0.00 ON	100	\$100.00	Promise CASH	Roy Wiesen	Proposed
<input type="checkbox"/>	2/2/2017	\$0.00	100	\$100.00	Promise	Roy Wiesen	Proposed

- Click **Override Payment Spread**. The **Override Payment Spread** dialog box appears.

Override Payment Spread

Accounts in Arrangement Group

Enable Override Payment Spread

	File Number	Client Code	Account Number	Balance	Status
1	1005	CUSTOMER ONE	7738201009121	\$100.00	NEW
2	1206	CUSTOMER TWO	773820665544	\$200.00	NEW

Enable Override Payment Spread: If selected, the system allows you to specify the payment spread order.

[Payment Spread Order]: Order in which to spread payments across the accounts. The system applies the payment to the account with a payment spread order of one (1) first and continues in sequential order until no payment amount remains to apply.

File Number: Unique code that the system assigned to identify the account.

Client Code: Unique code that your organization assigned to identify the client.

Account Number: Code that the client assigned to identify the account.

Balance: Current amount due on the account.

Status: Unique code that identifies the account status.

- Click **Override**. The **Override Payment Spread** dialog box closes.
- In the **Scheduled Payments** card, click **Save**. The system saves the override settings you specified and displays "Custom Spread Override Enabled" in the Payer column of the **Scheduled Payments** card. (Click the arrow next to the Hold? column to see the message.) If the payment

arrangement has a status of "proposed," the system changes it to "scheduled." If the account has at least one SIF arrangement, "Settlement in Progress" appears next to the "Scheduled Payments" heading.

Payment Instruments

Payment Instruments

You can add and select credit card and ACH payment instruments when scheduling payment arrangements. To reuse a payment instrument, save it to the customer's wallet.

Add a Credit Card

Use the **Card** tab in the **Payment Instrument** dialog box to add a credit card to the **Method** list box. You must have the Credit Cards Permission.

Important!

If you are taking the credit card information over the phone and Latitude is recording the call, Latitude automatically pauses the recording while the **Payment Instrument** dialog box is open. When you close the dialog box, Latitude resumes recording.

To add a credit card

- In the **Task Panel** navigation tree, do one of the following:
 - Click **Payments**.
 - Click **Arrangements**.
- Click the plus sign (+) next to the **Method** list box. The **Payment Instrument** dialog box appears.
- Click the **Add** tab and then click **Card**.

The screenshot shows the 'Payment Instrument' dialog box with the 'Card' tab selected. The form includes the following fields and controls:

- Card #:** Required (text input)
- Name:** Required (text input)
- Expiration:** 08 Aug (dropdown) 2020 (text input)
- Security Code:** Required (text input)
- Save to Wallet
- Red error message: Invalid account number, Invalid expiration date, Missing security code, Missing payor name
- Buttons: Add, Help, OK

Card #: Credit card number.

Name: Name as it appears on the credit card.

Expiration: Credit card expiration month and year.

Security Code: Three-digit security code that appears on the back of the credit card.

Save to Wallet: If selected, the system saves the credit card information to the customer's wallet using the following naming convention: "[Name on credit card]-CC-[last four digits of the credit card account number]." For example, "John Smith-CC-1111." The system tokenizes the credit card information. When taking a payment in the future, you can select this credit card and the system uses Payment Vendor Gateway to retrieve the token.

Replace Existing?: If selected and a payment instrument already exists, the system replaces the payment instruments in the current arrangement with the payment instrument that you select. If a payment instrument doesn't exist already, the system doesn't display this check box.

Remove Existing?: If selected and the existing payment instrument is not used in a future arrangement, the system removes the payment instrument. If a payment instrument doesn't exist already, the system doesn't display this check box.

4. Complete the information and then click **OK**. The credit card is available for selection in the **Method** list box.

Note: If the credit card does not match an existing credit card type (for example, Visa), an error message appears. For more information about maintaining credit card types, see *Credit Card Types*.

Add an ACH or Paper Draft Account

Use the **ACH** or **Paper Draft** tab in the **Payment Instrument** dialog box to add an Automated Clearing House (ACH) or paper draft account to the **Method** list box.

Important!

If you are taking the ACH or paper draft information over the phone and Latitude is recording the call, Latitude automatically pauses the recording while the **Payment Instrument** dialog box is open. When you close the dialog box, Latitude resumes recording.

To add an ACH or paper draft account

1. In the **Task Panel** navigation tree, do one of the following:
 - Click **Payments**.
 - Click **Arrangements**.
2. Click the plus sign (+) next to the **Method** list box. The **Payment Instrument** dialog box appears.
3. Click the **Add** tab and then click **ACH** or **Paper Draft**.

The screenshot shows a form for adding a payment instrument. At the top, there are buttons for 'Add' and 'Lookup'. Below that, there are tabs for 'Card', 'ACH' (selected), 'Paper Draft', and 'Direct Debit'. The form includes several input fields: 'Routing Information' (with a search icon), 'Account Number', 'Name', 'Street 1', 'Street 2', 'City', 'Sta', and 'Postal'. There are also radio buttons for 'Checking' (selected) and 'Savings', and a checkbox for 'Use Current Address as Billing Address'. At the bottom, there is a checkbox for 'Save to Wallet' and an 'Add' button. A red error message is displayed below the 'Save to Wallet' checkbox, stating: 'Invalid account number, Invalid routing information, Missing payor name, Missing payor address 1, Missing payor state, Missing payor city, Missing payor postal code'. There is also an 'OK' button in the bottom right corner.

Routing Information: Bank routing number.

Account Number: Checking or savings account number.

Checking: If selected, the account is a checking account.

Savings: If selected, the account is a savings account.

Name: Name on the checking or savings account.

Use Current Address as Billing Address: If selected, use the customer's address that is on file as the billing address.

Address: If the **Use Current Address as Billing Address** check box is cleared, the address boxes are available. Type the street address, city, state, and postal code associated to the account.

Save to Wallet: If selected, the system saves the information to the customer's wallet using the following naming convention: "Type-[last four digits of the account number]." For example, "ACH-4545" or "PD-4545." The system tokenizes the account information. When taking a payment in the future, you can select this account and the system uses Payment Vendor Gateway to retrieve the token.

Replace Existing?: If selected and a payment instrument already exists, the system replaces the payment instruments in the current arrangement with the payment instrument that you select. If a payment instrument doesn't exist already, the system doesn't display this check box.

Remove Existing?: If selected and the existing payment instrument is not used in a future arrangement, the system removes the payment instrument. If a payment instrument doesn't exist already, the system doesn't display this check box.

If selected, the system deletes the account that you specify. This check box appears when one or more accounts of this type exist.

- To search for a routing number, do the steps to [Search for an ABA Routing Number](#).

5. Complete the information and then click **OK**. The ACH or paper draft account is available for selection in the **Method** list box.

Add a Direct Debit Account

Use the **Direct Debit** tab in the **Payment Instrument** dialog box to add a Direct Debit account to the **Method** list box for one-time use only. You cannot save the account to the wallet. You must have the Direct Debit Permission.

Important!

If you are taking the Direct Debit account information over the phone and Latitude is recording the call, Latitude automatically pauses the recording while the **Payment Instrument** dialog box is open. When you close the dialog box, Latitude resumes recording.

To add a Direct Debit account

1. In the **Task Panel** navigation tree, do one of the following:
 - Click **Payments**.
 - Click **Arrangements**.
2. Click the plus sign (+) next to the **Method** list box. The **Payment Instrument** dialog box appears.
3. Click the **Add** tab and then click **Direct Debit**.

The screenshot shows the 'Payment Instrument' dialog box. At the top, there are two tabs: 'Add' and 'Lookup'. Below the tabs, there are four buttons for payment methods: 'Card', 'ACH', 'Paper Draft', and 'Direct Debit'. The 'Direct Debit' button is highlighted in yellow. Below the buttons, there are two input fields: 'Bank Account #' and 'Bank Sort'. At the bottom of the dialog box, there are three buttons: 'Add', 'Help', and 'DD Guarantee'. An 'OK' button is located at the bottom right of the dialog box.

Bank Account #: Eight-digit number that identifies the bank account from which to draw Direct Debit payments.

Bank Sort: Six-digit sort code used to validate the bank account number.

4. To view the Direct Debit guarantee for the account, click **DD Guarantee**.

Direct Debit Guarantee.

• This Guarantee is offered by all banks and building societies that accept instructions to pay Direct Debits. • If there are any changes to the amount, date or frequency of your Direct Debit ERUDIO/HONOURS will notify you 10 working days in advance of your account being debited or as otherwise agreed. If you request ERUDIO/HONOURS to collect a payment, confirmation of the amount and date will be given to you at the time of the request • If an error is made in the payment of your Direct Debit by ERUDIO/HONOURS or your bank or building society you are entitled to a full and immediate refund of the amount paid from your bank or building society • If you receive a refund you are not entitled to, you must pay it back when ERUDIO/HONOURS asks you to • You can cancel a Direct Debit at any time by simply contacting your bank or building society. Written confirmation may be required. Please also notify us.



5. When finished, click **OK**.
6. Complete the information to add the Direct Debit and then click **OK**. The Direct Debit account is available for selection in the **Method** list box.

Search for an ABA Routing Number

Use the **Add** tab in the **Payment Instrument** dialog box to search for a financial institution's American Bankers Association (ABA) routing number for a checking or savings account.

To search for an ABA routing number

1. In the **Task Panel** navigation tree, do one of the following:
 - Click **Payments**.
 - Click **Arrangements**.
2. Click the Search icon next to the **Method** list box. The **Payment Instrument** dialog box appears.
3. Click the **Add** tab and then click **ACH** or **Paper Draft**.

Latitude Printable Help

Card **ACH** Paper Draft Direct Debit

Routing Information: Required

Account Number:

Checking
 Savings

Name:

Use Current Address as Billing Address

Address:

Save to Wallet

Invalid account number, Invalid routing information, Missing payor name, Missing payor address 1, Missing payor state, Missing payor city, Missing payor postal code

- Click the Search icon next to **Routing Information**. The search options appear.

Card **ACH** Paper Draft

Routing Information:

Account Number:

Search for ABA #

Search Type:
 Address Phone # Bank Name

- Do one of the following:
 - To search by address. click **Address** and then type the address criteria.
 - To search by phone number, click **Phone #** and then type the full or partial phone number.
 - To search by bank name, click **Bank name** and then specify the full or partial name of the financial institution.
- Click **Search**. The search results appear.

Add
Lookup

Card ACH Paper Draft

Routing Information: Q

Account Number:

Search for ABA #

Search Type:

Address Phone # Bank Name

Phone

Search

ABA	Bank Name	Address	
041205369	HUNTINGTON NATIONAL BANK	7 EASTON OVAL COLUMBUS , OH	Select
041215634	HUNTINGTON NATIONAL BANK	EA2W40 COLUMBUS , OH	Select
041284461	HUNTINGTON NATIONAL BANK	EA2W40 COLUMBUS , OH	Select
042101459	HUNTINGTON NATIONAL BANK	7 EASTON OVAL COLUMBUS ,	Select

7. Scroll to locate the financial institution and then click **Select**. The system populates the **Routing Information** box.
8. Continue the steps to [Add an ACH or Paper Draft Account](#).

Search for a Credit Card

Use the **Lookup** tab in the **Payment Instrument** dialog box to search for a credit card and add it to the **Method** list box.

To search for a credit card

1. In the **Task Panel** navigation tree, do one of the following:
 - Click **Payments**.
 - Click **Arrangements**.
2. Click the Search icon next to the **Method** list box. The **Payment Instrument** dialog box appears.
3. Click the **Lookup** tab and then click **Card**.

The screenshot shows the 'Payment Instrument' dialog box with the 'Lookup' tab selected. At the top, there are three tabs: 'Add', 'Lookup', and 'Wallet'. Below the tabs, there are three buttons: 'Card', 'ACH', and 'Paper Draft'. A text input field labeled 'Last Four Digits:' is present. Below the input field, there are two buttons: 'Lookup' and 'Help'. At the bottom right of the dialog box, there is an 'OK' button.

4. In the **Last Four Digits** box, type the last four digits of the credit card number and then click **Lookup**. The system displays the credit card in the **Method** list box.

Search for an ACH or Paper Draft Account

Use the **Lookup** tab in the **Payment Instrument** dialog box to search for an Automated Clearing House (ACH) or paper draft account and add it to the **Method** list box.

To search for an ACH or paper draft account

1. In the **Task Panel** navigation tree, do one of the following:
 - Click **Payments**.
 - Click **Arrangements**.
2. Click the Search icon next to the **Method** list box. The **Payment Instrument** dialog box appears.
3. Click the **Lookup** tab and then click **ACH** or **Paper Draft**.

The screenshot shows the 'Payment Instrument' dialog box with the 'Lookup' tab selected. At the top, there are three tabs: 'Add', 'Lookup', and 'Wallet'. Below the tabs, there are three buttons: 'Card', 'ACH', and 'Paper Draft'. A text input field labeled 'Last Four Digits:' is present. Below the input field, there are two buttons: 'Add' and 'Help'. At the bottom right of the dialog box, there is an 'OK' button.

4. In the **Last Four Digits** box, type the last four digits of the account number and then click **Lookup**. The system displays the account in the **Method** list box.

Delete a Wallet Item

Use the **Wallet** tab in the **Payment Instrument** dialog box to delete a credit card, ACH, or paper draft account from the customer's wallet.

To delete a wallet item

- In the **Task Panel** navigation tree, do one of the following:
 - Click **Payments**.
 - Click **Arrangements**.
- Click the Wallet icon next to the **Method** list box. The **Payment Instrument** dialog box appears.
- Click the **Wallet** tab.

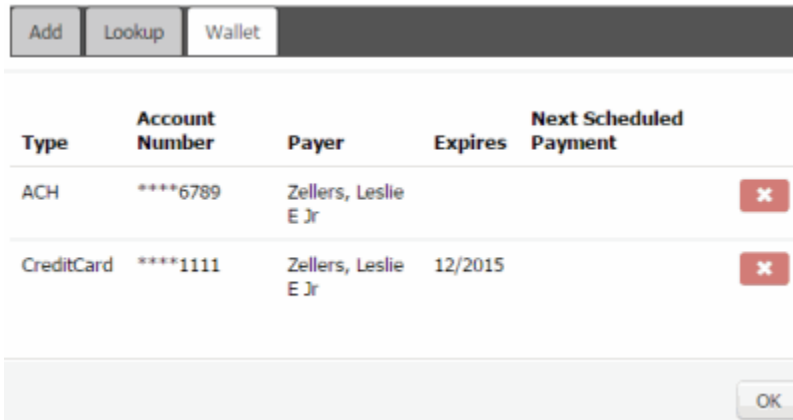

- Click the **X** next to the wallet item and then click **OK**.
- In the confirmation dialog box, click **Yes**.

Reschedule a Payment Arrangement

Use the **Scheduled Payments** card in the **Arrangements** panel to reschedule a payment arrangement.

To reschedule a payment arrangement

- In the **Task Panel** navigation tree, click **Arrangements**.

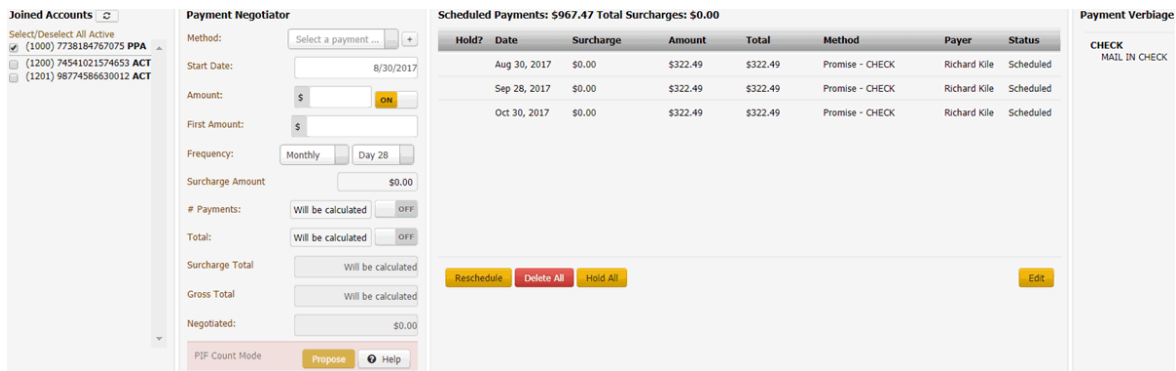

- Click **Reschedule**. The system displays the Payment Negotiator in rescheduling mode.

Joined Accounts card

If the account displayed currently is a joined account, the system displays the **Joined Accounts** card. If the account is not a joined account, the system hides this card. By default, the system selects the check box next to the account displayed currently and includes it first in the list. Then, the system lists all other accounts associated to the *customer* displayed currently. If there are closed accounts in the list, they appear in red.

Total: Refreshes the data in the **Joined Accounts** card.

Select/Deselect All Active: Selects or clears the check boxes next to each account.

[Include Account]: If selected, the system includes the account in the arrangement and in the total account balance.

Payment Negotiator card

Method: Method to use to process the payments. You can select an existing payment method or click the plus sign (+) to [add one](#). If you select "Promise," specify the payment type the party promises to use to pay. The system doesn't display expired credit cards in this list box.

Start Date: Due date for the first payment in the arrangement.

Amount: Amount of each payment. This amount defaults to a single payment for the total amount due on the account, excluding surcharges. If you set the indicator to "ON," specify the amount of each payment. If you set the indicator to "OFF," the system calculates the payment amount based on the account balance and number of payments.

First Amount: Down payment amount. Specify an amount here when the customer wants to pay an amount on the first payment that differs from the remaining payments. For example, the customer wants to pay \$300 down and \$200 per month for the remaining balance.

Frequency: How often a payment is due on the account. If you select "Monthly," specify the day of the month the payment is due (for example, the fifth day of the month). If you select "Monthly Pick," specify the time of the month payment is due. For example, the first Friday of the month. If you select "Four Weekly," the frequency is one payment every four weeks. If you select "Daily," the system still skips weekends and holidays.

Surcharge Amount: Amount to include as a surcharge for each payment in the arrangement. If you have the appropriate permissions, an "ON" indicator appears. To remove the surcharge, set the indicator to "OFF." The system removes the surcharge amount. For more information about surcharges, see [Surcharge Rules](#).

Payments: Number of payments in the arrangement. If you set the indicator to "ON," specify the number of payments. If you set the indicator to "OFF," the system calculates the number of payments based on the account balance and payment amount.

Total: Total scheduled amount for all the payments in the arrangement, excluding surcharges. If you set the indicator to "ON," specify the total payment amount. If you set the indicator to "OFF," the system calculates the total payment amount based on the account balance, number of payments, and interest accrual amount.

Is Settlement: If selected, this payment arrangement settles the account in full, regardless of the account balance. If there is an existing scheduled payment ready to process in the **Scheduled Payments** card or your organization doesn't allow SIF arrangements, the system hides this check box. You cannot schedule a SIF arrangement until you process the scheduled payment.

Minimum: Percent of the account balance to pay. This box displays when the **Is Settlement** check box is selected. If you specify a percent, the system calculates the settlement amount. If the amount is below the minimum settlement amount allowed, the system places the arrangement on hold and displays a message indicating the settlement amount requires approval.

[Amount]: Amount of the account balance to pay. This box displays when the **Is Settlement** check box is selected. If you specify an amount, the system calculates the settlement percent.

3. Modify the information and then click **Propose**. The rescheduled payment arrangement appears in the **Scheduled Payments** card with a "proposed" status.

Note: If an account in the arrangement has a "closed" status, a message displays indicating that you cannot propose an arrangement on a closed account. Remove the closed account from the arrangement.

4. To save the arrangement, click **Save**. If the payment arrangement has a status of "proposed," the system changes it to "scheduled." If the account has at least one SIF arrangement, "Settlement in Progress" appears next to the "Scheduled Payments" heading.

Place All Scheduled Arrangements on Hold

Use the **Scheduled Payments** card in the **Arrangements** panel to place all scheduled payments in an arrangement on hold.

To place all scheduled arrangements on hold

1. In the **Task Panel** navigation tree, click **Arrangements**.

Latitude Printable Help

The screenshot shows the 'Payment Negotiator' interface. On the left, there are 'Joined Accounts' and a 'Payment Negotiator' form with fields for Method, Start Date, Amount, First Amount, Frequency, Surcharge Amount, # Payments, Total, Surcharge Total, Gross Total, and Negotiated. The 'Hold All' button is highlighted in yellow. On the right, the 'Scheduled Payments' table is displayed with columns: Hold?, Date, Surcharge, Amount, Total, Method, Payer, and Status. The table contains three rows of scheduled payments for August, September, and October 2017. Below the table are buttons for 'Reschedule', 'Delete All', 'Hold All', and 'Edit'.

Hold?	Date	Surcharge	Amount	Total	Method	Payer	Status
	Aug 30, 2017	\$0.00	\$322.49	\$322.49	Promise - CHECK	Richard Kile	Scheduled
	Sep 28, 2017	\$0.00	\$322.49	\$322.49	Promise - CHECK	Richard Kile	Scheduled
	Oct 30, 2017	\$0.00	\$322.49	\$322.49	Promise - CHECK	Richard Kile	Scheduled

2. Click **Hold All** and in the confirmation dialog box, click **OK**. The system places a red padlock icon in the Hold column of the data grid. This feature isn't available for Direct Debit payment arrangements.
3. To remove the hold, click **Unhold All** and in the confirmation dialog box, click **OK**. The system removes the red padlock icon from the Hold column of the data grid.

Approve or Deny a SIF Arrangement

Use the **Scheduled Payments** card in the **Arrangements** panel to approve or deny a SIF arrangement with a settlement amount that falls below the minimum settlement amount allowed. The system places the arrangement on hold until you approve it.

Note: If you don't have permission to approve or deny the SIF arrangement, assign the account to the Supervisor queue for processing. For more information about permissions, see the "% Allowed Below Minimum" policy in the User Policy Permission.

To approve or deny a SIF arrangement

1. In the **Task Panel** navigation tree, click **Arrangements**.

The screenshot shows the 'Payment Negotiator' interface with a 'Settlement in Progress - Awaiting Approval' status. The 'Scheduled Payments' table has columns: Hold?, Date, Surcharge, Amount, Total, Method, Payer, and Status. The table contains four rows of scheduled payments for August, September, October, and November 2017, all with a status of 'Unapproved'. Below the table are buttons for 'Reschedule', 'Delete All', 'Approve', 'Deny', and 'Edit'.

Hold?	Date	Surcharge	Amount	Total	Method	Payer	Status
	Aug 30, 2017	\$0.00	\$150.00	\$150.00	Promise - CHECK	Richard Kile	Unapproved
	Sep 28, 2017	\$0.00	\$150.00	\$150.00	Promise - CHECK	Richard Kile	Unapproved
	Oct 30, 2017	\$0.00	\$150.00	\$150.00	Promise - CHECK	Richard Kile	Unapproved
	Nov 28, 2017	\$0.00	\$150.00	\$150.00	Promise - CHECK	Richard Kile	Unapproved

2. In the **Scheduled Payments** card, do one of the following:
 - To approve the SIF arrangement, click **Approve**. Latitude removes the hold and changes the status to "scheduled."
 - To deny the SIF arrangement, click **Deny**. Latitude deletes the arrangement.

Account Selection

The **Arrangements** panel defaults to the account displayed currently and the party selected in the [Account Navigator card](#). If the account is linked or the party is the primary party on the account, the system displays the **Account Selection** data grid. The data grid includes accounts based on the trust accounting configuration for the parties on the accounts. If you assigned all accounts to the general trust account or the configuration permits posting to the general trust account instead of the party's trust account, you can select multiple accounts. If the party on an account has its own trust account and doesn't permit deposits to the general trust account, only select accounts configured to use the same trust account.

Payment Spread Selection

If you selected multiple accounts for the arrangement and your organization configured the Payment Spread Permission, you can specify a payment spread method. Otherwise, the system sets a default payment spread method.

Payment Spread Method	Rule
In order	<ul style="list-style-type: none"> The system applies payments to the accounts in the selected order (for example, current balance, original balance, customer priority). When a party pays an account to satisfaction, the system applies any remaining payment amount to the next account in the order until there are no more payments or all accounts are paid. If you have permissions to select a payment spread, you can also specify the order of the accounts manually.
Even	<ul style="list-style-type: none"> The system splits payments evenly across all selected accounts. When a party pays an account to satisfaction, the system applies any remaining payment amount evenly to the remaining accounts.
Proportional	The system splits payments proportionally across all selected accounts based on the projected current balance on the date of the payment. In theory, if you set the arrangement to satisfy all accounts, all selected accounts are paid to satisfaction on the same payment.
Priority	<ul style="list-style-type: none"> The system applies payments toward the selected accounts based on the priority of the customer. If multiple accounts belong to customers with the same priority, the system applies payments proportionally to the projected current balance on the date of the payment.

<p>Fee</p>	<ul style="list-style-type: none"> • The system applies payments toward the selected accounts in the order of the payment yielding the highest amount of fee for the agency. • For each payment, the system calculates the projected fee using the fee schedules for the accounts for the full amount of the payment. The system sorts accounts by that projected fee in descending order and spreads the payment over those accounts in that order.
------------	--

Settlement Selection

If you have the appropriate permissions and select multiple accounts, you can specify a settlement amount for each account or all accounts proportionally based on the minimum settlement percentage of each account. You can also specify a lock-in settlement percent for a single account and then adjust the percentages on the other accounts.

Policies can alter the blanket settlement percentage set at the client level that drives the minimum settlement percentages for each account.

- The system can adjust the settlement percentage by a set number of percentage points based on the state in which the party resides.
- The system can adjust the settlement percentage by a set number of percentage points, a percentage of the settlement, or override it by a set percentage for the current user.
- If the payment instrument policy doesn't allow settlements below the blanket settlement and the adjusted settlement percentage is below the blanket settlement, the system sets it to the blanket settlement.

The system can also apply the settlement percentage to one of the following calculated money amounts:

- **Net original balance with interest:** Original balance plus all adjustment transactions and accrued interest.
- **Net original:** Original balance and all adjustment transactions without accrued interest.
- **Original balance with interest:** Original balance plus accrued interest but without adjustment transactions.
- **Original balance:** Original balance without adjustment transactions or accrued interest.
- **Current balance:** Current balance of the account at the time you take the arrangement.

The system can apply a second settlement percentage toward the current balance for accounts that already have partial payments and both amounts need satisfied to create a settlement arrangement. For example, the original balance of the account was \$100.00. The blanket settlement percentage is 60% and there was a payment of \$60.00 on the account. The account technically already meets the settlement requirements. By specifying a 20% current balance requirement to create a settlement arrangement, you must create an arrangement of at least \$8.00. Otherwise, with no additional requirements for a settlement, you can create an arrangement for a penny and have that considered a settlement arrangement.

Payment Arrangement Types

There are three types of payment arrangements that you can negotiate. All three types allow you to negotiate them as a settlement.

- **Single Payment:** For the current date or a future date, and for a specific amount or a percentage of the balance. The payment results summary shows the amount paid or promised, the balance remaining on the account, and the balance percent paid or remaining.
- **Recurring Payments:** Start on a specific date, occur with the same frequency (for example, weekly or monthly), and are for an equal amount. You can adjust individual payment dates and amounts; however, if you modify the other parameters, the system doesn't save your date and amount changes. The payment results summary shows the amount and date of each payment, and the balance remaining on the account after the entire stream.
- **Recurring PIF or SIF payments:** Start on a specific date and occur with the same frequency (for example, weekly or monthly). The system splits the payment amounts based on the negotiated total amount paid or the negotiated balance percent paid at the end of the stream. You can adjust individual payment dates and amounts; however, if you modify the other parameters, the system doesn't save your date and amount changes. The payment results summary shows the amount and date of each payment, the total amount paid after the stream, and the balance remaining on the account after the entire stream.

Payment Arrangement Scenarios

The following table provides payment arrangement scenarios for a single account. Each scenario shows the number of payments, the total account balance, the default amount for each payment, the modification to the payment, the result of the modification, and any warnings.

Scenario	Payments	Total Balance	Each Payment Default	Modify	Result	Warning
1	1	\$1000				
2	2	\$1000	\$500	Each amount = \$400	Number of payments = 3	Payment 3 estimated at \$200.
3	2	\$1000	\$500	Total amount = \$500	Each amount = \$250	
4	2	\$1000	\$500	Each amount = \$250	Number of payments = 4 or total amount = \$500 with "Is	

					Settlement" check box selected.	
5	2	\$1000	\$500	Payments = 4	No changes in values.	Overpayment estimated at \$1000.

Arrangement Negotiator States

The initial state when you start an arrangement negotiation is PIF mode. The following settings do not affect the arrangement negotiator state:

- **Method:** Defaults to "Promise."
- **Start Date:** Defaults to the current date.
- **Frequency:** Defaults to "Monthly."
- **Total:** Defaults to the total account balance for the selected accounts.
- **Negotiated:** Defaults to the total account balance for the selected accounts.

The following diagram illustrates the various arrangement negotiator states and how your changes to the payment amount, number of payments, and settlement indicator affect the state.

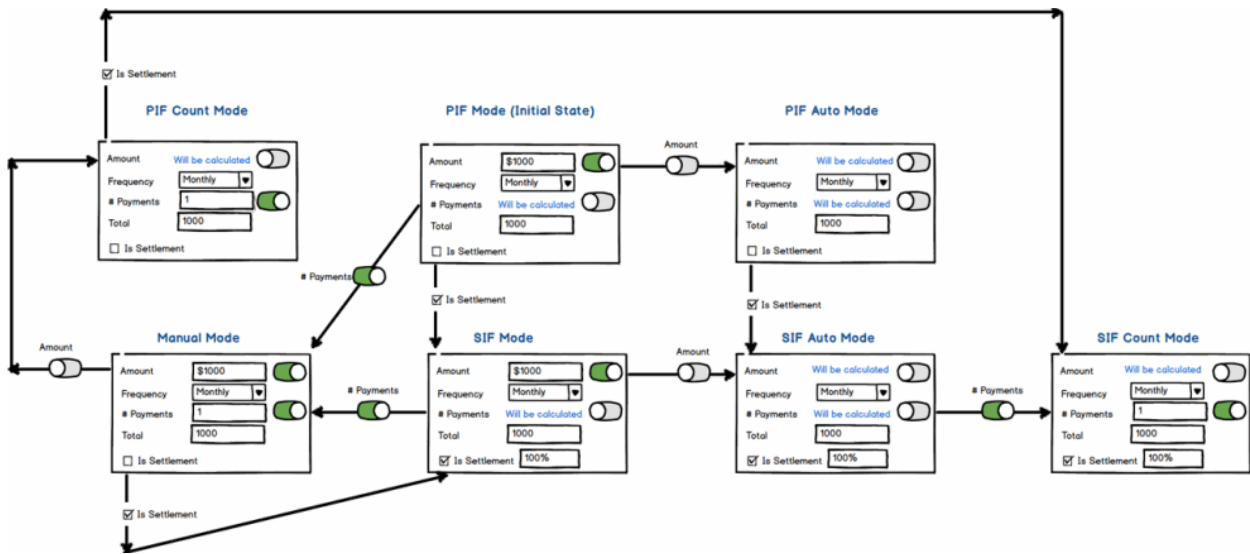

PIF mode

Amount: Defaults to "on" with an amount equal to the total account balance for the selected accounts. With the number of payments off and the **Is Selected** check box cleared, if you turn off the payment amount, the system changes the arrangement state to PIF auto mode.

Payments: Defaults to "off" to indicate that the system calculates the number of payments. With the amount on and the **Is Selected** check box cleared, if you turn on the number of payments, the system changes the arrangement state to manual mode.

Is Settlement: Defaults to cleared. With the amount on and the number of payments off, if you select this check box, the system changes the arrangement state to SIF mode.

PIF auto mode

Amount: Defaults to "off" to indicate that the system calculates the payment amount.

Payments: Defaults to "off" to indicate that the system calculates the number of payments.

Is Settlement: Defaults to cleared. With the amount off and the number of payments off, if you select this check box, the system changes the arrangement state to SIF auto mode.

PIF count mode

Amount: Defaults to "off" to indicate that the system calculates the payment amount.

Payments: Defaults to "on" with a single payment.

Is Settlement: Defaults to cleared. With the amount off and the number of payments on, if you select this check box, the system changes the arrangement state to SIF count mode.

Manual mode

Amount: Defaults to "on" with an amount equal to the total account balance for the selected accounts. With the number of payments on and the **Is Selected** check box cleared, if you turn off the payment amount, the system changes the arrangement state to PIF count mode.

Payments: Defaults to "on" with a single payment.

Is Settlement: Defaults to cleared. With the amount on and the number of payments on, if you select this check box, the system changes the arrangement state to SIF mode.

SIF mode

Amount: Defaults to "on" with an amount equal to the total account balance for the selected accounts. With the number of payments off and the **Is Selected** check box selected, if you turn off the payment amount, the system changes the arrangement state to SIF auto mode.

Payments: Defaults to "off" to indicate that the system calculates the number of payments. With the amount on and the **Is Selected** check box selected, if you turn on the number of payments, the system changes the arrangement state to manual mode.

Is Settlement: Defaults to "true" with a percentage of the account balance to pay set to 100%. With the amount on and the number of payments off, if you clear this check box, the system changes the arrangement state to PIF mode.

SIF auto mode

Amount: Defaults to "off" to indicate that the system calculates the payment amount.

Payments: Defaults to "off" to indicate that the system calculates the number of payments. With the amount off and the **Is Selected** check box selected, if you turn on the number of payments, the system changes the arrangement state to SIF count mode.

Is Settlement: Defaults to "true" with a percentage of the account balance to pay set to 100%. With the amount off and the number of payments off, if you clear this check box, the system changes the arrangement state to PIF auto mode.

SIF count mode

Amount: Defaults to "off" to indicate that the system calculates the payment amount.

Payments: Defaults to "on" with a single payment.

Is Settlement: Defaults to "true" with a percentage of the account balance to pay set to 100%. With the amount off and the number of payments on, if you clear this check box, the system changes the arrangement state to PIF count mode.

Surcharge Rules

The following rules apply to surcharges on payment arrangements:

- If your organization specified a surcharge amount for a payment method or a client fee, a surcharge amount displays when creating a payment arrangement based on the following:
- If the maximum surcharge amount for client fees is blank, the system applies the surcharge amount set up for the payment method (if there is one).
- If the maximum surcharge amount for client fees is zero (0), the system doesn't apply a surcharge amount (regardless if one is set up for the payment method).
- If the maximum surcharge amount for client fees is greater than zero (0), the system applies this surcharge amount.
- For linked accounts with different clients, the system applies the client surcharge amount or payment method surcharge amount, whichever is lowest.
- If your organization allows you to suppress the surcharge on new arrangements, you can remove the surcharge amount when creating a payment arrangement. For more information, see User Policy Permission.
- If a customer resides in a state that doesn't allow surcharges, the surcharge amount on the payment arrangement is zero and you cannot change it. For more information, see State Restriction.

Payments

Payments

Use the **Arrangements** panel to process a single payment within an arrangement, and use the **Batch Processor** page to process a batch of payment transactions for charge-off accounts.

Process a Payment

Use the **Arrangements** panel to process a payment that is due on the current date or earlier.

To process a payment

1. In the **Task Panel** navigation tree, click **Arrangements**.

The screenshot displays the 'Payment Negotiator' interface. On the left, there is a 'Joined Accounts' list with three entries: (1000) 7738184767075 PPA, (1200) 74541021574653 ACT, and (1201) 98774586630012 ACT. The main area is divided into two sections: 'Payment Negotiator' and 'Scheduled Payments: \$967.47 Total Surcharges: \$0.00'.

The 'Payment Negotiator' section includes fields for Method (a dropdown), Start Date (8/30/2017), Amount, First Amount, Frequency (Monthly/Day 28), Surcharge Amount (\$0.00), # Payments (Will be calculated), Total (Will be calculated), Surcharge Total (Will be calculated), Gross Total (Will be calculated), and Negotiated (\$0.00). There are also 'Propose' and 'Help' buttons at the bottom.

The 'Scheduled Payments' section contains a table with the following data:

Hold?	Date	Surcharge	Amount	Total	Method	Payer	Status
	Aug 30, 2017	\$0.00	\$322.49	\$322.49	Promise - CHECK	Richard Kile	Scheduled
	Sep 28, 2017	\$0.00	\$322.49	\$322.49	Promise - CHECK	Richard Kile	Scheduled
	Oct 30, 2017	\$0.00	\$322.49	\$322.49	Promise - CHECK	Richard Kile	Scheduled

Below the table are buttons for 'Reschedule', 'Delete All', 'Hold All', and 'Edit'. To the right, there is a 'Payment Verbiage' section with 'CHECK' and 'MAIL IN CHECK' options.

- In the **Scheduled Payments** card, click **Process**. The system processes the payment, updates the account balance to reflect the payment, and changes the payment status to "completed."

Notes:

- If the system declines a credit card or ACH payment, Latitude places the remaining payments in the arrangement on hold.
- If the arrangement is for a closed account, a message displays indicating that you cannot process a payment for a closed account.
- If the arrangement is for linked accounts, the system doesn't include any closed accounts in the payment spread.

Process a Payment Batch

Use the **Batch Processor** page to process a batch of credit card, paper draft, ACH debit, or Direct Debit transactions for charge-off accounts processed on the **Arrangements** or **Payments** panel. The transactions must be active and not on hold, cannot exceed the balance, and are due on the current date or earlier for accounts with an open status. You must have the Access Batch Wizard Permission to process a payment batch.

When you process transactions, the system creates a payment batch for each payment type. The batches include charge-off accounts that the system processed with the vendor but didn't batch already. The system uses the batches to post transactions to the affected accounts. For information about processing a batch to post transactions to accounts, see *Process a Batch* in the Latitude Console documentation.

The batches do not include delinquent accounts. The system updates account balances for delinquent accounts during a nightly process and reflects the balances on the accounts the following day.

To process a payment batch

- Open the **Latitude by Genesys** page.

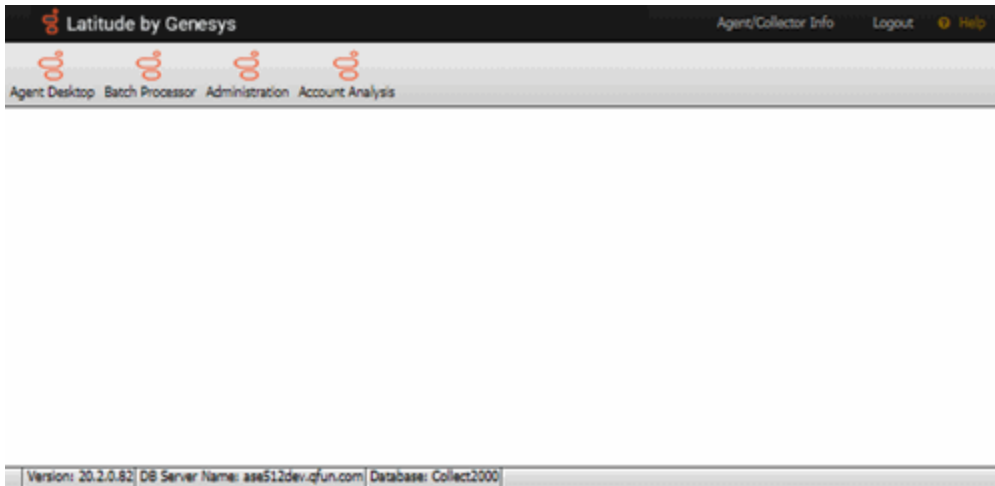

2. In the menu bar, click **Batch Processor**.

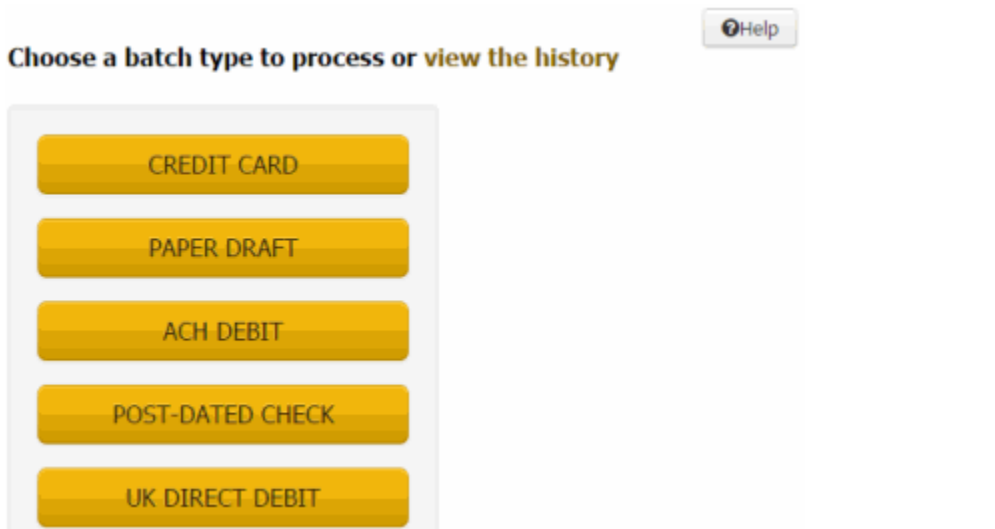

3. Click the type of payment batch to process. A confirmation message appears.

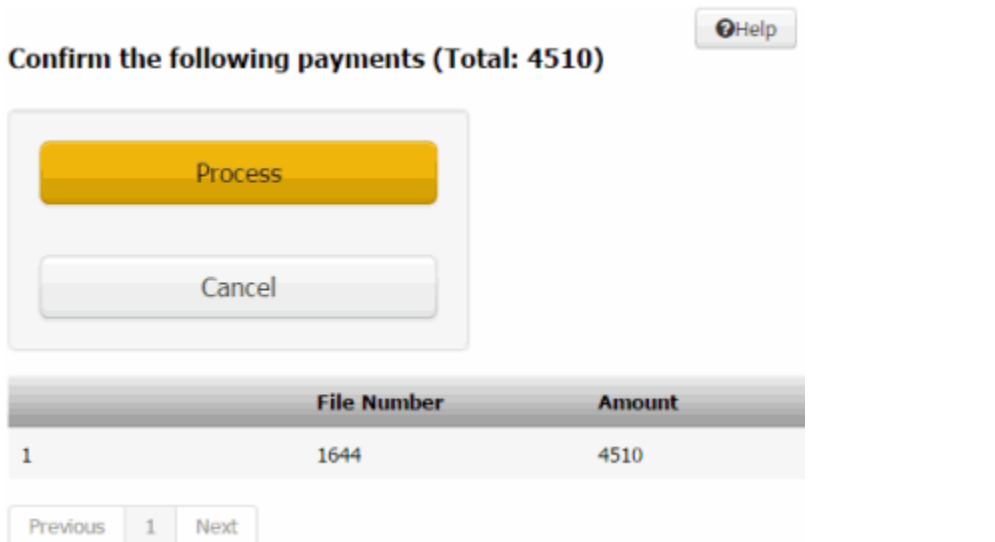

- Click **Process**. When payment processing is complete, the system displays the results and updates payment history for each account processed.

Notes:

- If payments from a previous session are still processing and you or the system interrupts the process (for example, you close the **Batch Processor** tab), a confirmation dialog box appears. Click **OK** to continue processing the previous session.
- If the payment vendor declines a payment during batch processing (for example, for insufficient funds), the system changes the future scheduled payments to "on hold."
- If an arrangement is for a closed account, a message displays indicating that you cannot process a payment for a closed account.
- If an arrangement is for linked accounts, the system doesn't include any closed accounts in the payment spread.

Batch Complete

Started:	Mon Jun 20 2016 11:23:55 GMT-0400 (Eastern Daylight Time)
Completed:	Mon Jun 20 2016 11:24:18 GMT-0400 (Eastern Daylight Time)
Processed:	1 (4500)
Succeeded:	1 (4500)
Failed:	0 (0)

Batch Details

All Clients														
Result	UID	Deposit Date	Amount	Surcharge	Total	Client	Desk	File Number	Account	Customer Id	ACH/CC#	Vendor Reference Number	Authorization Code	Message
Success	15	6/20/16	\$4,500.00	\$10.00	\$4,500.00	0000010	0000000	1644	332001245178	947	****1111	O6V3V3HWMSF1	478R11	

Previous 1 Next

Result: Outcome of processing the payment batch.

UID: Code that Latitude assigned to identify a payment.

Deposit Date: Date the payment deposited to the account.

Amount: Payment amount, excluding the surcharge.

Surcharge: Surcharge amount.

Total: Sum of the payment amount and surcharge.

Client: Unique code that identifies the client on the account.

Desk: Desk that processed the payment.

File Number: Unique code that the system assigned to identify the account.

Account: Code that the client assigned to identify the account.

Customer ID: Code that identifies a party on the account.

ACH/CC#: Last four digits of the credit card, checking, or savings account number.

Vendor Reference Number: Code that the payment vendor assigned to identify the transaction.

Authorization Code: Code that indicates whether the transaction is authorized or declined.

Message: Note regarding the transaction.

5. On the **Batch Processor** page, click the **X** to close the tab.

View Payment Batch History

Use the **Batch Processor** page to view processing information for payment batches. You must have the Access Batch Wizard Permission to view payment batch history.

To view payment batch history

1. Open the **Latitude by Genesys** page.

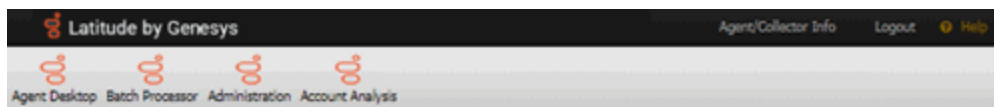

Version: 20.2.0.82 | DB Server Name: ase512dev.qfun.com | Database: Collect2000

2. In the menu bar, click **Batch Processor**.

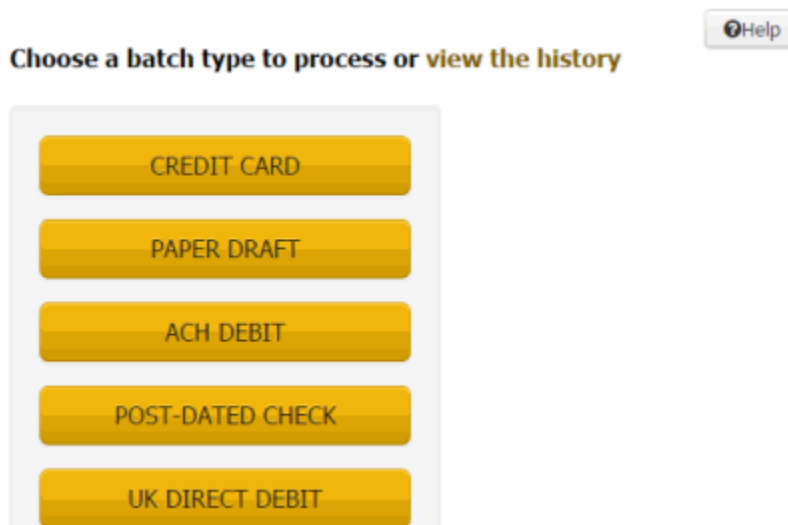

3. Click the "**view the history**" link.

Choose a batch run to view or process a batch Help

Payment Batch Run Id	Started	Completed	User	Total Count	Success Count	Failed Count
1	6/20/16 1:27 pm	6/20/16 1:27 pm	GSadmin	1	1	0
2	6/20/16 2:18 pm	6/20/16 2:19 pm	GSadmin	2	2	0
3	6/20/16 2:23 pm	6/20/16 2:23 pm	GSadmin	1	0	1
4	6/20/16 3:23 pm	6/20/16 3:24 pm	GSadmin	1	1	0

Payment Batch Run ID: Code that Latitude assigns to identify a batch of payments.

Started: Date and time Latitude started processing the batch of payments.

Completed: Date and time Latitude completed processing the batch of payments.

User: Code that identifies the user who processed the batch of payments.

Total Count: Total number of payments in the batch.

Success Count: Number of payments that processed successfully.

Failed Count: Number of payments that failed to process.

- To view details for a payment batch, click the batch.

Back Help

Batch Details

All Clients

Result	UID	Deposit Date	Amount	Surcharge	Total	Client	Desk	File Number	Account	Customer Id	ACH/CC#	Vendor Reference Number	Authorization Code	Message
Success	12	6/20/16	\$20.00	\$10.00	\$20.00	0000000	NEW	2137	75110535520	1440	****1111	OQFHWPFRPNP3	478R09	
Success	13	6/20/16	\$50.00	\$10.00	\$50.00	0000001	0000000	1000	7738184767075	294	****1111	993IN457MIX83	478R10	

Previous 1 Next

Result: Outcome of processing the payment batch.

UID: Code that Latitude assigned to identify a payment.

Deposit Date: Date the payment deposited to the account.

Amount: Payment amount, excluding the surcharge.

Surcharge: Surcharge amount.

Total: Sum of the payment amount and surcharge.

Client: Unique code that identifies the client on the account.

Desk: Desk that processed the payment.

File Number: Unique code that the system assigned to identify the account.

Account: Code that the client assigned to identify the account.

Customer ID: Code that identifies a party on the account.

ACH/CC#: Last four digits of the credit card, checking, or savings account number.

Vendor Reference Number: Code that the payment vendor assigned to identify the transaction.

Authorization Code: Code that indicates whether the transaction is authorized or declined.

Message: Note regarding the transaction.

Latitude Printable Help

5. To display batch details for a specific client, click in the **All Clients** list box and then click the client ID. To remove the filter, backspace over the ID.
6. To return to the payment history list, click **Back**.
7. On the **Batch Processor** page, click the **X** to close the tab.

View Applied and Planned Payments

Use the **Agent/Collector Information** page to view processed payments and planned payments (post-dated checks, credit cards, and promises) for a specific date range. You must have the View Other User Payments Permission to view payments for other users.

To view applied and planned payments

1. In the Application toolbar, click **Agent/Collector Info**.

The screenshot shows the 'Agent/Collector Information' page. At the top, there is a search bar with 'gs' entered, an 'Include Desk' checkbox, and date filters for 'From: 01/01/2017' and 'To: 01/31/2017'. There are 'Apply' and 'Clear' buttons. Below the filters, there are two tabs: 'Payments Applied' and 'Payments Planned'. A table with columns 'File Number', 'Name', 'Type', 'Collections', 'Fee', 'Date', 'Customer', and 'Comment' is visible. Below the table, there are 'Previous', '1', and 'Next' buttons. A summary bar at the bottom of the table area shows '0 items totaling \$0.00'. A 'Close' button is located at the bottom right of the page.

Users: Users for which to display payments. The following rules apply:

- If you have permission to view payments for other users, the list box includes all users.
- If you don't have permission to view payments for other users and you are:
 - A team lead, the list box includes users on your team only.
 - Not a team lead, the list box includes your user ID only.

Include Desk: If selected, includes payments that the selected user's desk received outside Latitude, such as by mail or Western Union.

From: Beginning date for which to display payments.

To: Ending date for which to display payments.

2. Specify the criteria for which payments to display and then click **Apply**.
3. To view payments applied to accounts, click the **Payments Applied** tab.

Agent/Collector Information

Users: Include Desk From: To:

Payments Applied **Payments Planned**

File Number	Name	Type	Collections	Fee	Date	Customer	Comment
1215	Smith, Landon	PU	\$55.00	\$13.75	1/11/17		

Previous 1 Next

1 item totaling \$55.00 and \$13.75 in fees.

File Number: Unique code that the system assigned to identify the account.

Name: Name of the customer on the account.

Type: Code that identifies the type of payment applied. For more information, see [Payment Type Codes](#).

Collections: Payment amount.

Fee: Collection fee.

Date: Payment date.

Customer: Code that identifies the client associated to the account.

Comment: Note regarding the payment.

- To view scheduled payments, click the **Payments Planned** tab.

Agent/Collector Information

Users: Include Desk From: To:

Type	File Number	Name	On Hold	Customer	Due Date	Amount
ACH	1215	Smith, Landon		10 - THIRD CUSTOMER	1/11/17	\$45.00
CreditCard	1214	Legere, Lauren	<input checked="" type="checkbox"/>	10 - THIRD CUSTOMER	1/11/17	\$10.00
CreditCard	1217	Berard, Angela		10 - THIRD CUSTOMER	1/11/17	\$12.00
CreditCard	1217	Berard, Angela		10 - THIRD CUSTOMER	1/11/17	\$88.00
Promise	1510	Cantara, James		10 - THIRD CUSTOMER	1/11/17	\$50.00
Promise	1000	Kile, Richard		1 - DEFAULT CUSTOMER	1/11/17	\$250.00

6 items totaling \$455.00.

Type: Payment method to use to process the payment (for example, credit card, ACH, paper draft, or promise).

File Number: Unique code that the system assigned to identify the account.

Name: Name of the customer on the account.

On Hold: If selected, the payment is on hold and the system doesn't process it when the due date arrives.

Customer: Code that identifies the client associated to the account.

Due Date: Date the payment is due.

Amount: Payment amount due, excluding the surcharge.

- When finished, click **Close**.

Payment Type Codes

Payment type codes identify payment types. The following table lists the payment type codes and their description.

Code	Description
DA	Decreasing Adjustment. An adjustment to an account that decreases the balance. The system doesn't calculate fees toward this amount and doesn't reflect the adjustment on invoices.
DAR	Decreasing Adjustment Reversal. An adjustment to an account that increases the balance. The system doesn't calculate fees toward this amount and doesn't reflect the adjustment on invoices.

PA	Paid Agency. A payment to an outside (subcontracted) agency that is collecting payments for your organization.
PAR	Paid Agency Reversal / Bounce. A payment by check to an outside (subcontracted) agency collecting on your organization's behalf where the check didn't clear.
PC	Paid to Client. A payment to your customer, where your organization holds the account.
PCR	Paid Client Reversal / Bounce. A payment by check to your customer, where your organization holds the account and the check didn't clear.
PU	Paid to Us. A payment sent directly to your organization.
PUR	Paid Us Reversal / Bounce. A payment by check that the customer sent directly to your organization where the check didn't clear.

Payment Status

The following table lists payment statuses and their description.

Status	Description
Authorized	Collector processed the payment. The payment vendor authorized the payment but hasn't charged it.
Batched	Collector processed the payment. The payment vendor authorized the payment and charged it. Collector posted the payment to payment history.
Bounced	Collector processed the payment. The payment vendor authorized the payment, charged it, and then reversed it for a reason such as insufficient funds. Collector posted the payment reversal to payment history.
Canceled	A user canceled the payment before processing occurred.
Completed	Collector processed the payment. The payment vendor authorized the payment and charged it.
Declined	Collector processed the payment and the payment vendor denied or declined it.
Locked	Collector is processing the payment, or a user is editing it. If locked for an extended period of time, it could indicate that the payment system crashed while processing the payment.
On Hold	Collector or a user placed the scheduled payment on hold or the scheduled payment is pending approval. Collector hasn't processed the payment.

Represent	Collector flagged the declined, voided, or bounced payment for reprocessing.
Scheduled	A user approved the scheduled payment and it's ready for processing on the scheduled payment date.
Superseded	A user canceled or deleted the payment, and possibly replaced it, without canceling the arrangement.
Voided	Collector processed the payment. The payment vendor authorized the payment, charged it, and then reversed it.

Letters

Letters



Use the **Letters** panel to request letters, view pending letter requests, delete pending letter requests, and view letter request history. You can also suspend and release a pending letter request. The letters available to you are based on settings in Letter Console. To print a requested letter, use Letter Console. For more information, see the *Letter Console* documentation.

Request a Letter

Use the **Request Letter** panel to request a letter for one or more parties on the account. The system restricts the available letters to those letters allowed for the account and client. You must have the Request Permission to request a letter. You must have the Linked Letters Permission to specify the linked accounts to include when requesting a linked letter.

To request a letter

1. In the **Task Panel** navigation tree, click **Letters** and then click **Request Letter**. The data grid displays the letters that are available for the account.

Code	Type	Description	Sender:	GSAdmin
00000	DUN	NewLetterTemplate	Recipient:	WIESEN, ROY
 1	DUN	First Notice	Send Date:	4/29/2016 
2	SIF	SIF	Subject Party:	WIESEN, ROY
 3	PPA	Payment Reminder		
4	PPS	MultiPart SIF		

Link Icon (): Indicates that the letter can include information for linked accounts.

Code: Code that identifies a letter.

Type: Type of letter. For more information, see [Letter Types](#).

Description: Description of the letter.

Sender: Person sending the letter.

Recipient: Person receiving the letter.

Send Date: Date to send the letter.

Subject Party: Person the letter is regarding.

Count: Number of payments (up to 25) to show in the letter. This box appears for a multipart SIF letter only.

Amount: Payment amount due. This box appears for payoff, settlement, payment reminder, and NITD letters.

Due Date: Date the payment is due. This box appears for payoff, settlement, payment reminder, and NITD letters.

2. In the data grid, select the letter to request. The information available is based on the letter selected. For example, some letters require payment amounts and dates.
3. If you selected a multipart SIF letter, do the following:
 - a. In the **Count** box, type or select the number of payments to show in the letter. **Amount** and **Due Date** boxes appear in the data grid for the number of payments specified.
 - b. Specify a payment amount and due date for each payment. The due dates must be at least one day apart. If an amount is zero when you click to send the request, the system deletes it from the data grid and doesn't include it in the letter.
 - c. To delete a payment, in the data grid, click the Delete icon. In the confirmation dialog box, click **Yes**.
4. Complete the information and then click **Send Request**. The letter request appears in the **Pending Letters** panel.

Note: The **Select Accounts** dialog box appears when the account is a linked account, the letter is a linked letter, and your organization configured the Linked Letters permission.

5. If the **Select Accounts** dialog box appears, do the steps to [Select Accounts](#). The letter request appears in the **Pending Letters** panel of each linked account that you select.

Note: The linked letter request feature is available beginning in SU 04 and doesn't affect letter requests created before upgrading to SU 04.

Select Accounts

Use the **Select Accounts** dialog box to select multiple linked accounts for which to change the account status or request a letter, depending on which task you are performing. This dialog box displays for linked accounts.

To select accounts

1. Do one of the following:
 - [Change an Account Status](#)
 - [Request a Letter](#)

The **Select Accounts** dialog box appears.

Select Accounts

<input checked="" type="checkbox"/>	File #	Account	Status	Balance	Has Active Arrangement?	Client	Patient Name	Date of Service	Contract Date	Chargeoff Date
<input checked="" type="checkbox"/>	1005	7738201009121	NEW	\$150.00	<input type="checkbox"/>	0000001			5/19/09	1/31/11
<input checked="" type="checkbox"/>	1206	773820665544	NEW	\$250.00	<input type="checkbox"/>	0000002			5/19/09	

Advanced

Save Close Help

Note: If closed accounts are excluded from the list, a check mark in a red box appears (as shown in the example). If closed accounts are included in the list, an **X** in a blue box appears.

2. Do one of the following:
 - To include closed accounts in the list, click the check mark in the red box. An **X** in a blue box appears in place of the check mark.
 - To remove closed accounts from the list, click the **X** in the blue box. A check mark in a red box appears in place of the **X**.
3. To select the accounts for which to change the status or request a letter, do one of the following:
 - To include all the linked accounts, select the check box next to **Select/Deselect All** in the column heading.
 - To exclude all the linked accounts (except the account you are working), clear the check box next to **Select/Deselect All** in the column heading.
 - To include an individual linked account, select the corresponding check box.
 - To exclude an individual linked account, clear the corresponding check box.
4. To specify advanced options, do the following:
 - a. Click **Advanced**. The advanced options appear.

Advanced

Client: Patient: Service Date:

Apply Clear

- b. To include accounts for a specific client, in the **Client** list box, click the client name.
 - c. To include accounts for a specific medical patient, in the **Patient** list box, click the patient name.
 - d. To include accounts for a specific date that the patient received medical care, in the **Service Date** list box, click the service date.
 - e. Click **Apply**.
5. Click **Save**. If you are changing the status and the selected accounts have an active payment arrangement, a confirmation dialog box appears. Click **OK**.

The system either changes the status of the specified accounts or requests a letter for the specified accounts, depending on what action lead you to this dialog box.

View Pending Letter Requests

Use the **Pending Letters** panel to view pending letter requests for the account. When the letter due date arrives, the letter is available to send using Letter Console.

To view pending letter requests

1. In the **Task Panel** navigation tree, click **Letters** and then click **Pending Letters**.

	Method	Code	Type	Description	Due Date	Sender	Recipient	State
	Print	1	DUN	First Notice	9/23/20	gs	BERNARD, TAMMY	Pending
	Print	1	DUN	First Notice	9/23/20	gs	BERNARD, TAMMY	Pending

Details Delete Email Print Help

Link Icon (): Indicates that the letter can include information for linked accounts.

Method: Method for delivering the letter.

Code: Code that identifies the letter.

Type: Type of letter requested.

Description: Description of the letter.

Due Date: Date the letter is due to send.

Sender: Person sending the letter.

Recipient: Person receiving the letter.

State: Status of the letter request.

2. To view details for a letter request, in the data grid, click the letter and then click **Details**. The **Details View** dialog box appears.

Details View

Letter Code: 1 Letter Type: 1 Method: Print Image Available: No Date Requested: 9/6/16 Date Processed: 9/6/16 Recipient: SHREIM, HENRY File #'s: 1600, 1601	Requester: GSAdmin Sender: gs Error Indicator: Amount Due: 2900 Due Date: 9/6/16 Deleted: No
--	---

Charged Off Bucket Snapshot (at time of printing)

Client Ref #	Client Code	Principal	Interest	Collection Costs	Bad Check Chgs	Court Cost	Attorney Fees	Misc			Transaction Charges
1600	0000012	\$2,900.00	\$0.00	\$0.00	\$0.00	\$0.00	\$0.00	\$0.00	\$0.00	\$0.00	\$0.00
1601	0000012	\$2,900.00	\$0.00	\$0.00	\$0.00	\$0.00	\$0.00	\$0.00	\$0.00	\$0.00	\$0.00

Close Help

Delete a Pending Letter Request

Use the **Pending Letters** panel to delete a pending letter request for the account. To delete a pending letter request, you must have the Delete Request permission.

To delete a pending letter request

1. In the **Task Panel** navigation tree, click **Letters** and then click **Pending Letters**.

	Method	Code	Type	Description	Due Date	Sender	Recipient	State
	Print	1	DUN	First Notice	4/29/16	gs	WIESEN, ROY	Pending

Details Hold Delete  Help

2. In the data grid, click the letter and then click **Delete**.
3. In the confirmation dialog box, click **OK**. The system records the deleted letter request in the **Letter History** panel.

Suspend a Pending Letter Request

Use the **Pending Letters** panel to place a hold on a pending letter request for the account. You cannot send a letter or delete a letter request while it is on hold. To place a letter request on hold, you must have the OnHold Request permission.

To suspend a pending letter request

1. In the **Task Panel** navigation tree, click **Letters** and then click **Pending Letters**.

	Method	Code	Type	Description	Due Date	Sender	Recipient	State
	Print	1	DUN	First Notice	4/29/16	gs	WIESEN, ROY	Pending

Details Hold Delete  Help

2. In the data grid, click the letter and then click **Hold**. The status of the letter request changes to "Held."

Release the Hold on a Pending Letter Request

Use the **Pending Letters** panel to release the hold on a pending letter request for the account. Once released, you can delete the letter request, or, if the letter due date is on or before the current date, send the letter using Letter Console.

To release the hold on a pending letter request

1. In the **Task Panel** navigation tree, click **Letters** and then click **Pending Letters**.

Method	Code	Type	Description	Due Date	Sender	Recipient	State
Print	1	DUN	First Notice	4/20/15	gs	DUGAN, SUSAN	Held

Details Release Delete Help

- In the data grid, click the letter and then click **Release**. The status of the letter request changes to "Pending."

View Letter Details

Use the **Details View** dialog box to view the details for a pending or historical letter for the account.

To view letter details

- In the **Task Panel** navigation tree, do one of the following:
 - For a pending letter, click **Letters** and then click **Pending Letters**. The **Pending Letters** panel appears.
 - For a historical letter, click **Letters** and then click **Letter History**. The **Letter History** panel appears.
- In the data grid, click a letter and then click **Details**.

Details View

Letter Code: 1	Requester: GSadmin
Letter Type: 1	Sender: gs
Method: Print	Error Indicator:
Image Available: No	Amount Due: 2900
Date Requested: 9/6/16	Due Date: 9/6/16
Date Processed: 9/6/16	Deleted: No
Recipient: SHREIM, HENRY	
File #'s 1600, 1601	

Charged Off Bucket Snapshot (at time of printing)

Client Ref #	Client Code	Principal	Interest	Collection Costs	Bad Check Chgs	Court Cost	Attorney Fees	Misc			Transaction Charges
1600	0000012	\$2,900.00	\$0.00	\$0.00	\$0.00	\$0.00	\$0.00	\$0.00	\$0.00	\$0.00	\$0.00
1601	0000012	\$2,900.00	\$0.00	\$0.00	\$0.00	\$0.00	\$0.00	\$0.00	\$0.00	\$0.00	\$0.00

Close Help

Letter Code: Code that identifies the letter.

Letter Type: Type of letter requested.

Method: Method for delivering the letter (for example, print, email, fax).

Image Available: Indicates whether an electronic image of the letter is available to view.

Date Requested: Date a user requested the letter.

Date Processed: Date a user sent the letter.

Recipient: Person who received the letter.

File #'s: System-assigned file numbers of the accounts included in the letter.

Requester: Person who requested the letter.

Sender: Person who sent the letter.

Error Indicator: Indicates that an error occurred when generating a letter in Letter Console. For example, if the letter contains an incomplete address, an error occurs.

Amount Due: Payment amount due.

Due Date: Payment due date.

Deleted: Indicates whether you canceled the pending letter request.

Client Ref #: Unique code that the system assigned to identify the account.

Client Code: Unique code that your organization assigned to identify the client.

Principal: Past due principal amount.

Interest: Past due interest amount.

Collection Costs: Past due collection costs.

Bad Check Chgs: Past due bad check charges.

Court Cost: Past due court costs.

Attorney Fees: Past due attorney fees.

Misc: Past due miscellaneous charges.

Transaction Charges: Past due transaction charges.

View Letter History

Use the **Letter History** panel to view the letters that a user requested for the account. An "x" in the last column of the data grid indicates that a user deleted the letter request before sending the letter.

To view letter history

1. In the **Task Panel** navigation tree, click **Letters** and then click **Letter History**.

	Method	Code	Type	Description	Date Requested	Date Sent	Sender	Recipient	Subject	
	Print	1	DUN	First Notice	4/29/16	4/29/16	gs	WIESEN, ROY	WIESEN, ROY	
	Print	1	DUN	First Notice	4/29/16		gs	WIESEN, ROY	WIESEN, ROY	

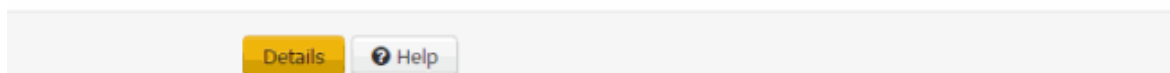

Link Icon (): Indicates that the letter can include information for linked accounts.

Method: Method for delivering the letter (for example, print, email, fax).

Code: Code that identifies the letter.

Type: Type of letter requested.

Description: Description of the letter.

Date Requested: Date a user requested the letter.

Date Sent: Date a user sent the letter.

Sender: Person who sent the letter.

Recipient: Person who received the letter.

Subject: Person the letter is regarding.

Note: If a Trash Can icon appears in the last column, a user deleted the letter request before sending the letter.

- To view details for a letter request, in the data grid, click the letter and then click **Details**. The **Details View** dialog box appears.

Letter Types

The following table lists the types of system-created letters that are available. For more information, see the Letter Console documentation.

Letter Type	Description
Dunning	Initial letter sent to the customer that contains balance and client information.
Settlement	Letter offering settlement terms to the customer.
Payoff	Letter to the customer confirming payoff of entire balance.
Payment Reminder	Letter reminding the customer to submit a payment.
Multi-Part Settlement	Letter confirming agreement with the customer to settle the balance following a payment schedule.
NITD	Notice of Intent to Deposit. Letter to notify the customer that your organization is depositing a post-dated check or paper draft.
Customer Letter	This letter type is not in use.
Attorney Letter	Letter to your organization's forwarding attorney regarding the customer.

Legal Case

Legal Case

Use the **Legal** panel to maintain court case information for customers in litigation for payment. Most of the data is available for creating merge letters for legal documents using Letter Console.

Maintain General Legal Information

Use the **General** tab to maintain general legal information for the account.

Notes:

- Before creating a legal case, link all accounts involved in the suit and unlink those that aren't.
- After creating a legal case, don't add other accounts to the link group as the system won't include them in the judgment. We recommend that you move the linked accounts to a desk that doesn't allow linking (**Prevent linking of accounts in this desk** check box is selected) to prevent adding accounts to the link group accidentally. For more information, see [Add a Desk](#), [Modify a Desk](#), and [Change a Desk Assignment](#).
- If you didn't link all the accounts involved in the suit or you didn't unlink accounts not involved in the suit before creating the legal case, do the following:

- Delete the legal case. For more information, see [Delete a Legal Case](#).
- Link the accounts involved in the suit and unlink the accounts not involved in the suit.
- (Recommended) Move the accounts to a desk that doesn't allow linking.
- Recreate the legal case.

To maintain general legal information

1. In the **Task Panel** navigation tree, do one of the following:
 - To add a court case, click **New Court Case**.
 - To modify a court case, click the court case number.

The **General** tab appears.

General	Court	Judgment	Garnishment	Accounting
Case Number:	<input type="text"/>	Trial Date:	<input type="text"/>	Remarks:
Status:	<input type="text" value="Unknown"/>	Arbitration Date:	<input type="text"/>	Misc Field 1:
Plaintiff:	<input type="text" value="CUSTOMER ONE"/>	Discovery Cut-off Date:	<input type="text"/>	Misc Field 2:
Defendant:	<input type="text" value="WIESEN, ROY"/>	Discovery Reply Date:	<input type="text"/>	
Date Complaint Filed:	<input type="text"/>	Motion Cut-off Date:	<input type="text"/>	
Date Answer Filed:	<input type="text"/>	Summary Judgment Deadline:	<input type="text"/>	
Service Date:	<input type="text"/>	Statutory Deadline to Try Case:	<input type="text"/>	
Service Type:	<input type="text"/>			

Confirm all accounts involved in the legal process are linked prior to creating a court case and set all accounts to a desk that is not allowed to be linked

Case Number: Court case number.

Status: Status of the legal case.

Plaintiff: Person who filed the complaint.

Defendant: Person defending the case. This box defaults to the primary customer's name.

Date Complaint Filed: Date the Plaintiff filed the complaint with the court.

Date Answer Filed: Date the Defendant filed the response to the complaint with the court.

Service Date: Date the court served notice to the Defendant.

Service Type: Type of legal service.

Trial Date: Date and time of the trial.

Arbitration Date: Date and time of arbitration.

Discovery Cut-off Date: Deadline for discovery requests.

Discovery Reply Date: Deadline for discovery responses.

Motion Cut-off Date: Deadline for filing a motion to reopen discovery.

Summary Judgment Deadline: Deadline for filing summary judgment motions.

Statutory Deadline to Try Case: Statutory deadline for trying the case.

Remarks: Comments regarding the case.

Misc Field 1: Use this box to store whatever information you choose.

Misc Field 2: Use this box to store whatever information you choose.

2. Complete the information and then click **Save**.

Assign a Court

Use the **Court** tab to assign a court to a legal case for the account. Specify a court case number on the **General** tab before assigning a court.

To maintain a court

1. In the **Task Panel** navigation tree, click a case number.
2. Click the **Court** tab.

General	Court	Judgment	Garnishment	Accounting
Court:	<input type="text" value="None"/>	Address:		<input type="text" value="Street Line 1"/>
Judge:	<input type="text"/>			<input type="text" value="Street Line 2"/>
Court Room:	<input type="text"/>			<input type="text" value="City"/> <input type="text" value="State"/>
				<input type="text" value="Postal Code"/>
				<input type="text" value="County"/> <input type="text" value="Country"/>
		Clerk:		<input type="text"/>
		Phone:		<input type="text"/>
		Fax:		<input type="text"/>
		Misc Info:		<input type="text"/>
<input type="button" value="Save"/> <input type="button" value="Help"/>				

Court: Name of the court.

Judge: Name of the presiding judge.

Court Room: Court room where the judge presides.

Address: Court address.

County: Court county.

Clerk: Name of the court clerk.

Phone: Court clerk's phone number.

Fax: Court clerk's fax number.

Misc Info: Miscellaneous information related to the court.

3. Complete the information and then click **Save**.

Judgments

Judgments

Use the **Judgment** tab to award and reverse judgments on the account. To award or reverse a judgment, you must specify a court case number, assign a court name, and specify a judgment spread.

Specify Judgment Award Amounts

Use the **Judgment** tab to specify the judgment award amounts for the account. Ensure that you specified a case number and assigned a court. For more information, see [Maintain General Legal Information](#) and [Assign a Court](#).

To specify judgment Award Amounts

1. In the **Task Panel** navigation tree, do one of the following:
 - To add a court case, click **New Court Case**, specify a court case number, and then click **Save**.
 - To modify a court case, click the court case number.
2. Click the **Judgment** tab.

General	Court	Judgment	Garnishment	Accounting
Date of Judgment:	<input type="text"/>	*		
Date Judgment Recorded:	<input type="text"/>			
Judgment Book:	<input type="text"/>			
Judgment Page:	<input type="text"/>			
Judgment Court:	<input type="text"/>			

Judgment Awards		Accrue Interest?	Previous Balance	
Principal:	<input type="text" value="0"/>	<input checked="" type="checkbox"/>	Principal:	<input type="text"/>
Interest:	<input type="text" value="0"/>	<input type="checkbox"/>	Interest:	<input type="text"/>
Court Cost:	<input type="text" value="0"/>	<input type="checkbox"/>	Collection Costs:	<input type="text"/>
Attorney:	<input type="text" value="0"/>	<input type="checkbox"/>	Bad Check Chgs:	<input type="text"/>
Other 1:	<input type="text" value="0"/>	<input type="checkbox"/>	Court Cost:	<input type="text"/>
Other 2:	<input type="text" value="0"/>	<input type="checkbox"/>	Attorney Fees:	<input type="text"/>
Other 3:	<input type="text" value="0"/>	<input type="checkbox"/>	Misc:	<input type="text"/>
Other 4:	<input type="text" value="0"/>	<input type="checkbox"/>	Not Used:	<input type="text"/>
Other 5:	<input type="text" value="0"/>	<input type="checkbox"/>	Not Used:	<input type="text"/>
Miscellaneous:	<input type="text" value="0"/>	<input type="checkbox"/>	Transaction Charges:	<input type="text"/>
Interest From Date:	<input type="text"/>			
Interest Rate:	<input type="text" value="0"/>			
Total Due on Judgment:	<input type="text" value="0"/>		Total Balance:	<input type="text"/>

A court needs to be added to the court case in the Court tab

A Judgment Spread must be created and balanced before the judgment can be awarded.

Date of Judgment: Date the court awarded judgment. You cannot save the judgment unless you specify this date.

Date Judgment Recorded: Date the court clerk recorded the judgment in the judgment book.

Judgment Book: Book that contains the recording information received from the court.

Judgment Page: Page that contains the recording information received from the court.

Judgment Court: Court that awarded the judgment. The system pulls this information from the Court tab.

Principal: Principal amount awarded in the judgment.

Interest: Interest amount awarded in the judgment.

Court Cost: Court costs awarded in the judgment.

Attorney: Attorney fees awarded in the judgment.

Other 1 through Other 5: Other fees awarded in the judgment. You can specify up to five other fees.

Miscellaneous: Miscellaneous costs awarded in the judgment.

Interest From Date: Date to start calculating interest on the total judgment award amount at the specified interest rate.

Interest Rate: Interest rate to use to calculate interest on the total judgment award amount.

Total Due on Judgment: Total amount that the court awarded on the judgment. The system calculates this amount. It doesn't include fees that you apply after the judgment date (for example, garnishment fees).

Accrue Interest: If selected, the system includes the associated money bucket when calculating accrued interest. You cannot select or clear the **Principal** or **Interest** check boxes. If your organization didn't map a money bucket to an award bucket, you cannot select or clear the corresponding check box.

Note: The system populates the following boxes and you cannot change them on this tab.

Principal: Amount of the account balance that is principal (money bucket 1).

Interest: Amount of the account balance that is interest (money bucket 2).

Transaction Charges: Amount of the account balance that is transaction charges (money bucket 10).

Note: The remaining amounts (for example, Collection Costs) are for money buckets 3 through 9. The labels vary based on how your organization set up your system. For more information, see Maintain Money Titles.

Total Balance: Total account balance (sum of all money buckets).

3. Complete the information and then click **Save**.

Note: You cannot save the judgment information until you specify a case number on the **General** tab, assign a court on the **Court** tab, and specify a judgment date on the **Judgment** tab.

4. Do the steps to [Spread Judgment Award Amounts](#).

Spread Judgment Award Amounts

Use the **Judgment Spread Calculator** dialog box to spread a judgment award across money buckets and any accounts linked to the account. You can have the system spread the award proportionally based on existing account balances or you can specify the amount to apply to each bucket and linked account.

To spread judgment award amounts

1. In the **Task Panel** navigation tree, do one of the following:
 - To add a court case, click **New Court Case**, specify a court case number, and then click **Save**.
 - To modify a court case, click the court case number.
2. Click the **Judgment** tab.

General	Court	Judgment	Garnishment	Accounting
Date of Judgment:	10/3/2016			
Date Judgment Recorded:	10/10/2016			
Judgment Book:	150			
Judgment Page:	20			
Judgment Court:	Jacksonville Court			

Judgment Awards		Accrue Interest?	Previous Balance
Principal:	2900	<input checked="" type="checkbox"/> Principal:	
Interest:	100	<input type="checkbox"/> Interest:	
Court Cost:	0	<input type="checkbox"/> Collection Costs:	
Attorney:	0	<input type="checkbox"/> Bad Check Chgs:	
Other 1:	0	<input type="checkbox"/> Court Cost:	
Other 2:	0	<input type="checkbox"/> Attorney Fees:	
Other 3:	0	<input type="checkbox"/> Misc:	
Other 4:	0	<input type="checkbox"/> Not Used:	
Other 5:	0	<input type="checkbox"/> Not Used:	
Miscellaneous:	0	<input type="checkbox"/> Transaction Charges:	
Interest From Date:			
Interest Rate:	0		
Total Due on Judgment:	3000	Total Balance:	
Accrued Interest:	0		

A Judgment Spread must be created and balanced before the judgment can be awarded.

3. Click **Judgment Spread Calculator**. The **Judgment Spread Calculator** dialog box appears.

Judgment Spread Calculator

AccountID	Principal	Interest	Court Costs	Attorney	Other 1	Other 2	Other 3	Other 4	Other 5	Misc	Total
1601	0	0	0	0	0	0	0	0	0	0	0
1600	0	0	0	0	0	0	0	0	0	0	0
Total	0	0	0	0	0	0	0	0	0	0	0

Total Judgment Award

	2900	100	0	0	0	0	0	0	0	0	3000
--	------	-----	---	---	---	---	---	---	---	---	------

Note: If the total amount for a specific column is greater than or less than the judgment amount awarded, the total box for that column appears with a red background.

Account ID: Unique code that the system assigned to identify the account. If a Link icon displays next to an account, the account is the driver (main) account in the group of joined accounts.

Notes:

- If the awarded amount is 100% of the amount owed, the system populates the following boxes with the amounts that exist on the account currently in the corresponding buckets.

- If the awarded amount is less than 100% of the amount owed, the system spreads the amount proportionally across the linked accounts and populates the following boxes with those amounts.
- The system applies awarded fees and costs to the link driver account only.
- If your organization didn't map a money bucket to an award bucket, you cannot specify a spread amount for that money bucket.

Principal: Amount of the award to apply to the Latitude money bucket that your organization mapped to the Principal award bucket.

Interest: Amount of the award to apply to the Latitude money bucket that your organization mapped to the Interest award bucket.

Court Costs: Amount of the award to apply to the Latitude money bucket that your organization mapped to the Court Costs award bucket.

Attorney: Amount of the award to apply to the Latitude money bucket that your organization mapped to the Attorney award bucket.

Other 1: Amount of the award to apply to the Latitude money bucket that your organization mapped to the Other 1 award bucket.

Other 2: Amount of the award to apply to the Latitude money bucket that your organization mapped to the Other 2 award bucket.

Other 3: Amount of the award to apply to the Latitude money bucket that your organization mapped to the Other 3 award bucket.

Other 4: Amount of the award to apply to the Latitude money bucket that your organization mapped to the Other 4 award bucket.

Other 5: Amount of the award to apply to the Latitude money bucket that your organization mapped to the Other 5 award bucket.

Misc: Amount of the award to apply to the Latitude money bucket that your organization mapped to the principal judgment award bucket.

Total: Total judgment amount awarded for the account.

Total (row): Total judgment amount awarded for each column. If the total amount for a specific column is greater than or less than the amount awarded, the total box for that column appears with a red background.

Total Judgment Award section - The system populates this section using the values you specified on the Judgments tab.

Principal: Judgment amount awarded for principal.

Interest: Judgment amount awarded for interest.

Court Costs: Judgment amount awarded for court costs.

Attorney: Judgment amount awarded for attorney costs.

Other 1 through Other 5: Judgment amount awarded for other costs.

Misc: Judgment amount awarded for miscellaneous costs.

[Column] Total: Total Judgment amount awarded.

[Row] Total: Total Judgment amount awarded.

4. Do one of the following:

- To spread the award proportionally, click **Distribute Proportionally**. The system calculates the spread based on the account balances and populates the boxes accordingly.

Judgment Spread Calculator

AccountId	Principal	Interest	Court Costs	Attorney	Other 1	Other 2	Other 3	Other 4	Other 5	Misc	Total
1601	1450	100	0	0	0	0	0	0	0	0	1550
1600	1450	0	0	0	0	0	0	0	0	0	1450
Total	2900	100	0	0	0	0	0	0	0	0	3000

Total Judgment Award

2900	100	0	0	0	0	0	0	0	0	0	3000
------	-----	---	---	---	---	---	---	---	---	---	------

- To specify the amount of the award to apply to each bucket and each linked account, type the amounts in the boxes.

Note: If the total amount to apply doesn't equal the total judgment amount awarded, the boxes appear in red and you cannot save your changes.

- Click **Save**.
- On the **Judgment** tab, click **Save**.
- Do the steps to [Award a Judgment](#).

Award a Judgment

Use the **Judgment** tab to award judgment on the account. You cannot award a judgment until you specify a judgment spread. For more information, see [Spread Judgment Award Amounts](#). You must have the Award/Reverse Judgment Permission and Judgment Award Bucket Mappings Permission.

To award a judgment

- In the **Task Panel** navigation tree, do one of the following:
 - To add a court case, click **New Court Case**, specify a court case number, and then click **Save**.
 - To modify a court case, click the court case number.
- Click the **Judgment** tab.

Latitude Printable Help

General	Court	Judgment	Garnishment	Accounting
Date of Judgment:	10/3/2016			
Date Judgment Recorded:	10/10/2016			
Judgment Book:	150			
Judgment Page:	20			
Judgment Court:	Jacksonville Court			

Judgment Awards		Accrue Interest?	Previous Balance
Principal:	2900	<input checked="" type="checkbox"/> Principal:	
Interest:	100	<input type="checkbox"/> Interest:	
Court Cost:	0	<input type="checkbox"/> Collection Costs:	
Attorney:	0	<input type="checkbox"/> Bad Check Chgs:	
Other 1:	0	<input type="checkbox"/> Court Cost:	
Other 2:	0	<input type="checkbox"/> Attorney Fees:	
Other 3:	0	<input type="checkbox"/> Misc:	
Other 4:	0	<input type="checkbox"/> Not Used:	
Other 5:	0	<input type="checkbox"/> Not Used:	
Miscellaneous:	0	<input type="checkbox"/> Transaction Charges:	
Interest From Date:			
Interest Rate:	0		
Total Due on Judgment:	3000	Total Balance:	

Save Judgment Spread Calculator Award Judgment Help Update Interest

3. Click **Award Judgment**. A confirmation dialog box appears.

Note: You cannot award the judgment until you specify a judgment spread.

4. Click **OK**. The system populates the money buckets in the **Previous Balance** column on the **Judgment** tab with the spread amounts.

General	Court	Judgment	Garnishment	Accounting
Date of Judgment:	<input type="text" value="10/3/2016"/>			
Date Judgment Recorded:	<input type="text" value="10/10/2016"/>			
Judgment Book:	<input type="text" value="150"/>			
Judgment Page:	<input type="text" value="20"/>			
Judgment Court:	<input type="text" value="Jacksonville Court"/>			
Judgment Awards - Judgment Awarded				
Principal:	<input type="text" value="2900"/>	<input checked="" type="checkbox"/> Accrue Interest?	Principal:	<input type="text" value="5800"/>
Interest:	<input type="text" value="100"/>	<input type="checkbox"/> Interest:		<input type="text" value="0"/>
Court Cost:	<input type="text" value="0"/>	<input type="checkbox"/> Collection Costs:		<input type="text" value="0"/>
Attorney:	<input type="text" value="0"/>	<input type="checkbox"/> Bad Check Chgs:		<input type="text" value="0"/>
Other 1:	<input type="text" value="0"/>	<input type="checkbox"/> Court Cost:		<input type="text" value="0"/>
Other 2:	<input type="text" value="0"/>	<input type="checkbox"/> Attorney Fees:		<input type="text" value="0"/>
Other 3:	<input type="text" value="0"/>	<input type="checkbox"/> Misc:		<input type="text" value="0"/>
Other 4:	<input type="text" value="0"/>	<input type="checkbox"/> Not Used:		<input type="text" value="0"/>
Other 5:	<input type="text" value="0"/>	<input type="checkbox"/> Not Used:		<input type="text" value="0"/>
Miscellaneous:	<input type="text" value="0"/>	<input type="checkbox"/> Transaction Charges:		<input type="text" value="0"/>
Interest From Date:	<input type="text"/>			
Interest Rate:	<input type="text" value="0"/>			
Total Due on Judgment:	<input type="text" value="3000"/>	Total Balance:		<input type="text" value="5800"/>
<input type="button" value="Save"/> <input type="button" value="Judgment Spread Calculator"/> <input type="button" value="Reverse Judgment"/> <input type="button" value="Help"/> <input type="button" value="Update Interest"/>				

Note: Custodian updates the interest on the linked accounts in the judgment when the nightly process runs. However, you can update the interest immediately. For more information, see [Update Interest on Linked Accounts in a Judgment](#).

Reverse a Judgment

Use the **Judgment** tab to reverse judgment on an appealed case or when the court entered the judgment in error for the account. You must have the Award/Reverse Judgment Permission and Judgment Award Bucket Mappings Permission.

To reverse a judgment

- In the **Task Panel** navigation tree, do one of the following:
 - To add a court case, click **New Court Case**, specify a court case number, and then click **Save**.
 - To modify a court case, click the court case number.
- Click the **Judgment** tab.

Latitude Printable Help

General	Court	Judgment	Garnishment	Accounting
Date of Judgment:	<input type="text" value="10/3/2016"/>			
Date Judgment Recorded:	<input type="text" value="10/10/2016"/>			
Judgment Book:	<input type="text" value="150"/>			
Judgment Page:	<input type="text" value="20"/>			
Judgment Court:	<input type="text" value="Jacksonville Court"/>			
Judgment Awards - Judgment Awarded				
Principal:	<input type="text" value="2900"/>	<input checked="" type="checkbox"/> Accrue Interest?	Principal:	<input type="text" value="5800"/>
Interest:	<input type="text" value="100"/>	<input type="checkbox"/> Interest:		<input type="text" value="0"/>
Court Cost:	<input type="text" value="0"/>	<input type="checkbox"/> Collection Costs:		<input type="text" value="0"/>
Attorney:	<input type="text" value="0"/>	<input type="checkbox"/> Bad Check Chgs:		<input type="text" value="0"/>
Other 1:	<input type="text" value="0"/>	<input type="checkbox"/> Court Cost:		<input type="text" value="0"/>
Other 2:	<input type="text" value="0"/>	<input type="checkbox"/> Attorney Fees:		<input type="text" value="0"/>
Other 3:	<input type="text" value="0"/>	<input type="checkbox"/> Misc:		<input type="text" value="0"/>
Other 4:	<input type="text" value="0"/>	<input type="checkbox"/> Not Used:		<input type="text" value="0"/>
Other 5:	<input type="text" value="0"/>	<input type="checkbox"/> Not Used:		<input type="text" value="0"/>
Miscellaneous:	<input type="text" value="0"/>	<input type="checkbox"/> Transaction Charges:		<input type="text" value="0"/>
Interest From Date:	<input type="text"/>			
Interest Rate:	<input type="text" value="0"/>			
Total Due on Judgment:	<input type="text" value="3000"/>	Total Balance:		<input type="text" value="5800"/>
<input type="button" value="Save"/> <input type="button" value="Judgment Spread Calculator"/> <input type="button" value="Reverse Judgment"/> <input type="button" value="Help"/> <input type="button" value="Update Interest"/>				

3. Click **Reverse Judgment**. A confirmation dialog box appears.
4. Click **OK**. The system clears the money buckets in the **Previous Balance** column on the **Judgment** tab and reverts the values on the account to their pre-judgment award amounts.

General	Court	Judgment	Garnishment	Accounting
Date of Judgment:	10/3/2016			
Date Judgment Recorded:	10/10/2016			
Judgment Book:	150			
Judgment Page:	20			
Judgment Court:	Jacksonville Court			

Judgment Awards		Accrue Interest?	Previous Balance
Principal:	2900	<input checked="" type="checkbox"/> Principal:	
Interest:	100	<input type="checkbox"/> Interest:	
Court Cost:	0	<input type="checkbox"/> Collection Costs:	
Attorney:	0	<input type="checkbox"/> Bad Check Chgs:	
Other 1:	0	<input type="checkbox"/> Court Cost:	
Other 2:	0	<input type="checkbox"/> Attorney Fees:	
Other 3:	0	<input type="checkbox"/> Misc:	
Other 4:	0	<input type="checkbox"/> Not Used:	
Other 5:	0	<input type="checkbox"/> Not Used:	
Miscellaneous:	0	<input type="checkbox"/> Transaction Charges:	
Interest From Date:			
Interest Rate:	0		
Total Due on Judgment:	3000	Total Balance:	

Update Interest on Linked Accounts in a Judgment

Use the **Judgment** tab to update interest on the linked accounts in an awarded judgment. Custodian updates the interest when the nightly process runs. However, you can update the interest immediately. You must have the Update Interest Permission.

To update interest on linked accounts in a judgment

- In the **Task Panel** navigation tree, do one of the following:
 - To add a court case, click **New Court Case**, specify a court case number, and then click **Save**.
 - To modify a court case, click the court case number.
- Click the **Judgment** tab.

General	Court	Judgment	Garnishment	Accounting
Date of Judgment:	10/3/2016			
Date Judgment Recorded:	10/10/2016			
Judgment Book:	150			
Judgment Page:	20			
Judgment Court:	Jacksonville Court			

Judgment Awards		Accrue Interest?	Previous Balance
Principal:	2900	<input checked="" type="checkbox"/> Principal:	
Interest:	100	<input type="checkbox"/> Interest:	
Court Cost:	0	<input type="checkbox"/> Collection Costs:	
Attorney:	0	<input type="checkbox"/> Bad Check Chgs:	
Other 1:	0	<input type="checkbox"/> Court Cost:	
Other 2:	0	<input type="checkbox"/> Attorney Fees:	
Other 3:	0	<input type="checkbox"/> Misc:	
Other 4:	0	<input type="checkbox"/> Not Used:	
Other 5:	0	<input type="checkbox"/> Not Used:	
Miscellaneous:	0	<input type="checkbox"/> Transaction Charges:	
Interest From Date:			
Interest Rate:	0		
Total Due on Judgment:	3000	Total Balance:	

3. Click **Update Interest**. A confirmation dialog box appears.
4. Click **OK**. The system updates the interest for all the linked accounts in the judgment.

Garnishments

Garnishments

Use the **Garnishments** tab to maintain wage garnishments for the account. To award or reverse a judgment, you must specify a court case number, assign a court name, and specify a judgment spread.

Add a Garnishment

Use the **New Garnishment** dialog box to add a wage garnishment for the account.

To add a garnishment

1. In the **Task Panel** navigation tree, click a case number.
2. Click the **Garnishment** tab.

General	Court	Judgment	Garnishment	Accounting
ID	Case Number	Garnishment Case Number:	<input type="text"/>	Principal Amount: £ <input type="text" value="0"/>
		Date Filed:	<input type="text"/>	Pre-judgment Interest: £ <input type="text" value="0"/>
		Expires:	<input type="text"/>	Post-judgment Interest: £ <input type="text" value="0"/>
		Service Date:	<input type="text"/>	Cost: £ <input type="text" value="0"/>
Garnishee: Company: <input type="text"/> * Address: Street Line 1: <input type="text"/> Street Line 2: <input type="text"/> City: <input type="text"/> County: <input type="text"/> Post Code: <input type="text"/> Country: <input type="text"/> Contact: <input type="text"/> * Phone: <input type="text"/> * Fax: <input type="text"/> Email: <input type="text"/>				Other Amounts: £ <input type="text" value="0"/>
				Total Amount: £ <input type="text" value="0"/>
<input type="button" value="Add New"/> <input type="button" value="Save"/> <input type="button" value="Delete"/> <input type="button" value="Help"/>				

3. Click **Add New**.

New Garnishment

Garnishment Case Number:	<input type="text"/>
Date Filed:	04/04/2016
Expires:	04/04/2016
Service Date:	04/04/2016
Principal Amount:	<input type="text" value="0"/>
Pre-judgment Interest:	<input type="text" value="0"/>
Post-judgment Interest:	<input type="text" value="0"/>
Cost:	<input type="text" value="0"/>
Other Amounts:	<input type="text" value="0"/>
Total Amount:	<input type="text" value="0"/>
Garnishee: <input type="text"/>	
<input type="button" value="Save"/> <input type="button" value="Close"/> <input type="button" value="Help"/>	

Garnishment Case Number: Court case number for the garnishment.

Date Filed: Date the client filed the garnishment with the court.

Expires: Date the garnishment ends.

Service Date: Date the court served the garnishment summons.

Principal Amount: Initial amount of money the garnishment is to repay.

Pre-judgment Interest: Interest that accrued before you went to court to obtain a judgment against the customer.

Post-judgment Interest: Interest on the judgment that accrues from the time the court clerk records the judgment until the customer pays the debt.

Cost: Costs for filing the garnishment, such as filing fees, that you can recover.

Other Amounts: Other costs related to the garnishment, such as processing fees, that you can recover.

Total Amount: Total amount of the garnishment. This amount includes the principal amount, interest, costs, and other amounts.

Company: Company to whom the court issued the garnishment summons.

Address: Garnishee's street address, city, state, postal code, county, and country.

Contact: Name of the contact person at the company.

Phone: Contact person's phone number.

Fax: Contact person's fax number.

Email: Contact person's email address.

4. Complete the information and then click **Save**.

Modify a Garnishment

Use the **Garnishment** tab to modify a wage garnishment for the account.

To modify a garnishment

1. In the **Task Panel** navigation tree, click a case number.
2. Click the **Garnishment** tab.
3. Click a garnishment case number to display its information.

ID	Case Number	Garnishment Case Number: 5544		Principal Amount:	\$ 10000.00		
9	5544	Date Filed:	4/20/2015	Pre-judgment Interest:	\$ 100.00		
		Expires:	4/20/2015	Post-judgment Interest:	\$ 100.00		
		Service Date:	4/20/2015	Cost:	\$ 500.00		
		Garnishee:			Other Amounts:	\$ 0.00	
		Company:	ABC Employer			Total Amount:	\$ 10700.00
		Address:	1000 Main St.				
			Street Line 2				
			Jacksonville	FL	32256		
			Duval	USA			
		Contact:	Matt Matthews				
		Phone:	5555555555				
		Fax:					
		Email:					

Add New Save Delete Help

Garnishment Case Number: Court case number for the garnishment.

Date Filed: Date the client filed the garnishment with the court.

Expires: Date the garnishment ends.

Service Date: Date the court served the garnishment summons.

Principal Amount: Initial amount of money the garnishment is to repay.

Pre-judgment Interest: Interest that accrued before you went to court to obtain a judgment against the customer.

Post-judgment Interest: Interest on the judgment that accrues from the time the court clerk records the judgment until the customer pays the debt.

Cost: Costs for filing the garnishment, such as filing fees, that you can recover.

Other Amounts: Other costs related to the garnishment, such as processing fees, that you can recover.

Total Amount: Total amount of the garnishment. This amount includes the principal amount, interest, costs, and other amounts.

Company: Company to whom the court issued the garnishment summons.

Address: Garnishee's street address, city, state, postal code, county, and country.

Contact: Name of the contact person at the company.

Phone: Contact person's phone number.

Fax: Contact person's fax number.

Email: Contact person's email address.

4. Complete the information and then click **Save**.

Delete a Garnishment

Use the **Garnishment** tab to delete a garnishment for the account.

To delete a garnishment

1. In the **Task Panel** navigation tree, click a case number.
2. Click the **Garnishment** tab.

ID	Case Number
9	5544

Garnishment Case Number: 5544

Date Filed: 4/20/2015

Expires: 4/20/2015

Service Date: 4/20/2015

Garnishee:

Company: ABC Employer

Address: 1000 Main St.

Street Line 2

Jacksonville FL 32256

Duval USA

Contact: Matt Matthews

Phone: 5555555555

Fax:

Email:

Principal Amount:	\$	10000.00
Pre-judgment Interest:	\$	100.00
Post-judgment Interest:	\$	100.00
Cost:	\$	500.00
Other Amounts:	\$	0.00
Total Amount:	\$	10700.00

Add New Save Delete Help

3. Click the garnishment case number and then click **Delete**.
4. In the Confirmation dialog box, click **OK**.

Accounting

Accounting

Use the **Accounting** tab to maintain legal accounting information for the account.

View Legal Accounting Information

Use the **Accounting** tab to view legal accounting information for the account.

To view legal accounting information

1. In the **Task Panel** navigation tree, click a case number.
2. Click the **Accounting** tab.

General									Court		Judgment		Garnishment		Accounting	
ID	Item Date	Description	Debit	Credit	Inv	Edit	Del	Type Code/Description:								
13	4/20/15	FILING FEES EXPENDED	\$1,000.00	\$0.00	N	+	-	Agency Id/Name:								
14	4/20/15	INVESTIGATOR FEES	\$100.00	\$0.00	N	+	-	Alpha Code:	Created Date:							
Balance:			\$1,100.00					AIM Unique Id:	AIM Invoice Id:							

ID: Code that identifies the transaction.

Item Date: Date the transaction occurred.

Description: Ledger account associated to the transaction.

Debit: Debit amount associated to the transaction.

Credit: Credit amount associated to the transaction.

Inv: Indicates whether the system invoiced the transaction.

Balance: Sum of the transaction amounts. If the system enclosed the balance in parentheses, the balance is a debit (or decreasing) amount. Otherwise, the balance is a credit (or increasing) amount.

The following information comes from the AIM program:

Type Code\Description: Unique code that identifies the ledger account and a description of the ledger account.

Agency ID\Name: Unique numeric code and name that identify the outside agency or attorney that holds the account.

Alpha Code: Alphanumeric code that identifies the outside agency or attorney that holds the account.

AIM Unique ID: Unique code that identifies the AIM transaction.

Created Date: Date the system or a user created the transaction in AIM.

AIM Invoice ID: Unique code that identifies the AIM invoice that included the transaction.

Add a Legal Ledger Item

Use the **New Legal Ledger Entry** dialog box to add a legal ledger item for the account.

To add a legal ledger item

1. In the **Task Panel** navigation tree, click a case number.
2. Click the **Accounting** tab and then click **Add New**.

New Legal Ledger Entry

Item Date:

Entry Types:
 Debit: (decreases / expenditures and costs incurred)
 Credit: (increases / costs advances)

Amount:
 (does not affect Debtors Account balance)

Legal Ledger Type:

AIM Agency:

AIM Unique Id:

AIM Invoice Id:

Item Date: Date the transaction occurred.

Entry Types: Indicates whether the ledger item is a debit or credit.

Amount: Debit or credit amount associated to the ledger item.

Legal Ledger Type: Type of ledger account.

AIM Agency: Name of the outside agency or attorney that holds the account.

AIM Unique ID: Unique code that identifies the AIM ledger item.

AIM Invoice ID: Unique code that identifies the AIM invoice that included the ledger item.

3. Complete the information and then click **Save**.

Modify a Legal Ledger Item

Use the **Edit Legal Ledger Entry** dialog box to modify a legal ledger item for the account.

To modify a legal ledger item

1. In the **Task Panel** navigation tree, click a case number.
2. Click the **Accounting** tab.

		General	Court	Judgment	Garnishment	Accounting		
ID	Item Date	Description	Debit	Credit	Inv	Edit	Del	Type Code/Description:
13	4/20/15	FILING FEES EXPENDED	\$1,000.00	\$0.00	N	+	-	<input type="text"/>
14	4/20/15	INVESTIGATOR FEES	\$100.00	\$0.00	N	+	-	<input type="text"/>
Balance:			\$1,100.00					Agency Id/Name: <input type="text"/>
								Alpha Code: <input type="text"/> Created Date: <input type="text"/>
								AIM Unique Id: <input type="text"/> AIM Invoice Id: <input type="text"/>
								<input type="button" value="Add New"/> <input type="button" value="Help"/>

3. Click an item in the data grid and then, in the Edit column, click the plus sign (+).

Edit Legal Ledger Entry

Item Date:	4/20/2015	
Entry Types:	<input checked="" type="radio"/> Debit: (decreases / expenditures and costs incurred) <input type="radio"/> Credit: (increases / costs advances)	
Amount:	\$	1000
(does not affect Debtors Account balance)		
Legal Ledger Type:	FILING FEES EXPENDED ▼	
AIM Agency:	Collections Plus Services ▼	
AIM Unique Id:	36514	
AIM Invoice Id:	69874	
<input type="button" value="Save"/> <input type="button" value="Close"/> <input type="button" value="Help"/>		

Item Date: Date the transaction occurred.

Entry Types: Indicates whether the ledger item is a debit or credit. You cannot modify the entry type. You can, however, delete the item on the **Accounting** tab and add a new one.

Amount: Debit or credit amount associated to the ledger item.

Legal Ledger Type: Type of ledger account.

AIM Agency: Name of the outside agency or attorney that holds the account.

AIM Unique ID: Unique code that identifies the AIM ledger item.

AIM Invoice ID: Unique code that identifies the AIM invoice that included the ledger item.

4. Modify the information and then click **Save**.

Delete a Legal Ledger Item

Use the **Accounting** tab to delete a legal ledger item for the account.

To delete a legal ledger item

1. In the **Task Panel** navigation tree, click a case number.
2. Click the **Accounting** tab.

Latitude Printable Help

ID	Item Date	Description	Debit	Credit	Inv	Edit	Del	Type Code/Description:	001	FILING FEES EXPENDED			
4	11/20/2013	FILING FEES EXPENDED	\$100.00	\$0.00	N	+	-	Agency Id/Name:	1	Collections Plus Services			
			Balance:	\$100.00						Alpha Code:		Created Date:	11/20/2013
					AIM Unique Id:	123	AIM Invoice Id:	4567					

3. Click an item in the data grid and then, in the Del column, click the minus sign (-).
4. In the confirmation dialog box, click **OK**.

Delete a Legal Case

Use the **General** tab to delete a legal case for the account. You cannot delete a legal case with an awarded judgment; however, you can reverse the judgment and then delete the legal case. To delete a legal case, you must have the Delete Legal Case permission.

To delete a legal case

1. In the **Task Panel** navigation tree, click the court case number. The **General** tab appears.

General	Court	Judgment	Garnishment	Accounting	
Case Number:	8877544	Trial Date:		Remarks:	
Status:	Suit Filed	Arbitration Date:		Misc Field 1:	
Plaintiff:	CUSTOMER ONE	Discovery Cut-off Date:		Misc Field 2:	
Defendant:	WIESEN, ROY	Discovery Reply Date:			
Date Complaint Filed:	10/31/2016	Motion Cut-off Date:			
Date Answer Filed:	11/1/2016	Summary Judgment Deadline:			
Service Date:		Statutory Deadline to Try Case:			
Service Type:					

Confirm all accounts involved in the legal process are linked prior to creating a court case and set all accounts to a desk that is not allowed to be linked

2. Click **Delete** and then, in the confirmation dialog box, click **OK**.

Care and Financial Hardship

Care and Financial Hardship

Use the **Care and Financial Hardship** panel to add or modify care or financial hardship cases for an account. You can add multiple cases; however, once you confirm a case, you cannot add more cases. You must have the Care and Financial Hardship Panel Permission.

Suspension of collection activity

Latitude places a hold on accounts with confirmed customer care or financial hardship to suspend all collection activity. When you close a care or financial hardship case and no others exist on the account, Latitude removes the account hold and collection activity resumes.

Add a Care or Financial Hardship Case

Use the **Add Care/Financial Hardship Case** dialog box to add a care or financial hardship case for the account.

To add a care or financial hardship case

1. In the **Task Panel** navigation tree, click **Care and Financial Hardship**.

2. Click **Add**.

Add Care/Financial Hardship Case

Care Type: Type of care, such as long-term illness or literacy issues. If the **Have Consent** check box is selected, this list box contains all available care types. If the **Have Consent** check box is cleared, this list box contains only care types that don't require consent.

Note: The first time you add a care record to an account, this list box contains all available care types.

The following boxes appear when you select "prison" from the **Care Type** list box:

Prison Name: Name of the prison where the person is incarcerated.

Prison Number: Person's prison identification number.

Sentence Date: Person's sentencing date.

Release Date: Person's prison release date.

Prison Informant: Person or system that notified you of the person's imprisonment.

Care Type Hold Days: Number of days to place the account on hold to suspend collection activity. Latitude populates this box with the default value for the selected care type.

Severity: Level of severity (1-10) for the care type. Latitude populates this box based on the selected care type.

Description: Description of the care case. Latitude populates this box based on the selected care type.

Have Consent: If selected, you have consent from the customer to discuss the care case. If cleared, the system only displays care types that don't require consent.

Confirmed Care: If selected, you confirmed the care case. The system places a collection hold on the account and sets the expiration date based on the number of days set for the care type. You cannot add other care cases. If cleared, the system doesn't place a collection hold on the account.

Proof Required: If selected, your organization requires proof of the care issue and you cannot clear this check box.

Proof Requested: If selected, your organization requested proof of the care issue. If your organization configured the **Care Type** code to require proof, this check box appears.

Proof Received: If selected, your organization received proof of the care issue. If you select the **Proof Requested** check box, this check box appears.

Financial Hardship: Type of financial hardship, such as unemployment or illness.

Hardship Type Hold Days: Number of days to place the account on hold to suspend collection activity. Latitude populates this box with the default value for the selected financial hardship type.

Description: Description of the financial hardship. Latitude populates this box based on the selected financial hardship type.

Proof Required: If selected, your organization requires proof of the financial hardship and you cannot clear this check box.

Proof Requested: If selected, your organization requested proof of the financial hardship. If your organization configured the **Hardship Type** code to require proof, this check box appears.

Proof Received: If selected, your organization received proof of the financial hardship. If you select the **Proof Requested** check box, this check box appears.

Contact Methods: If selected, you can contact the customer using the specified contact method. Latitude requires you to select at least one contact method.

Special Requirements: If selected, the customer has a special-needs requirement for contact.

Hold Days: Number of days to place the account on hold to suspend collection activity. When you select the **Confirmed Care** check box, Latitude populates this box with the default value. If you have the appropriate permissions, you can override this value. Latitude uses the hold days value to calculate the hold release date. When the hold release date expires, Latitude removes the hold on the account.

Times in Care: Number of times the customer has been in care. Latitude sums the number of care records added for the customer to calculate this value.

Status: Status of the care or financial hardship case, such as proof confirmed or proof not required. If you select "closed," Latitude changes the closed date to the current date.

Comments: Notes regarding the care or financial hardship case.

3. Complete the information and then click **Save**.

Modify a Care or Financial Hardship Case

Use the **Edit Care/Financial Hardship Case** dialog box to modify a care or financial hardship case for the account.

To modify a care or financial hardship case

1. In the **Task Panel** navigation tree, click **Care and Financial Hardship**.

2. In the data grid, click a case and then click **Edit**.

Care Type: Type of care, such as long-term illness or literacy issues. If you select the **Have Consent** check box, this list box contains all available care types. If you clear the **Have Consent** check box, this list box contains only the care types that don't require consent.

Care Type Hold Days: Number of days to place the account on hold to suspend collection activity. Latitude populates this box with the default value for the selected care type.

Severity: Level of severity (1-10) for the care type. Latitude populates this box based on the selected care type.

Description: Description of the care case. Latitude populates this box based on the selected care type.

Have Consent: If selected, you have consent from the customer to discuss care information. If cleared, the system only displays care types that don't require consent.

Confirmed Care: If selected, you confirmed that the account is in care. The system places a collection hold on the account and sets the expiration date based on the number of days set for the care type. You cannot add other care cases. If cleared, the system doesn't place a collection hold on the account.

Proof Required: If selected, your organization requires proof of the care issue and you cannot clear this check box.

Proof Requested: If selected, your organization requested proof of the care issue. If your organization configured the **Care Type** code to require proof, this check box appears.

Proof Received: If selected, your organization received proof of the care issue. If you select the **Proof Requested** check box, this check box appears.

Financial Hardship: Type of financial hardship, such as unemployment or illness.

Hardship Type Hold Days: Number of days to place the account on hold to suspend collection activity. Latitude populates this box with the default value for the selected financial hardship type.

Description: Description of the financial hardship. Latitude populates this box based on the selected financial hardship type.

Proof Required: If selected, your organization requires proof of the financial hardship and you cannot clear this check box.

Proof Requested: If selected, your organization requested proof of the financial hardship. If your organization configured the **Hardship Type** code to require proof, this check box appears.

Proof Received: If selected, your organization received proof of the financial hardship. If you select the **Proof Requested** check box, this check box appears.

Contact Methods: If selected, you can contact the customer using the specified contact method. Latitude requires you to select at least one contact method.

Special Requirements: If selected, the customer has a special-needs requirement for contact.

Hold Days: Number of days to place the account on hold to suspend collection activity. When you select the **Confirmed Care** check box, Latitude populates this box with the default value. If you have the appropriate permissions, you can override this value. Latitude uses the hold days value to calculate the hold release date. When the hold release date expires, Latitude removes the hold on the account.

Hold Days Approved: If selected, a supervisor approved the number of hold days. Latitude requires supervisor approval when the hold days are greater than 30. Supervisors can determine which accounts require approval using the "HoldDaysNeedApproval" condition in the Account Analysis query tool. For more information about Account Analysis, see "Account Analysis" in the *Latitude Console* documentation.

Expiration Date: Date the account hold expires and Latitude removes the hold on the account.

Status: Status of the care or financial hardship case, such as proof confirmed or proof not required. If you select "closed," Latitude changes the closed date to the current date.

Times in Care: Number of times the customer has been in care. Latitude sums the number of care records added for the customer to calculate this value.

Comments: Notes regarding the care or financial hardship case.

3. Modify the information and then click **Save**.

Approve Care and Financial Hardship Hold Days

Use the **Edit Care/Financial Hardship Case** dialog box to approve a customer care or financial hardship case with hold days that are greater than 30. Supervisors can determine which accounts require approval using the "HoldDaysNeedApproval" condition in the Account Analysis query tool or the WorkFlow Designer program. For more information about Account Analysis, see "Account Analysis" in the *Latitude Console* documentation. For more information about WorkFlow Designer, see the *WorkFlow Designer* documentation.

To approve care or financial hardship hold days

1. In the **Task Panel** navigation tree, click **Care and Financial Hardship**.

2. In the data grid, click a case and then click **Edit**.

3. Select **Hold Days Approved** and then click **Save**.

Complaints

Complaints

Use the **Complaints** panel to add, modify, close, and reopen complaints for an account. Users work complaints in order based on complaint type, days until Service Level Agreement (SLA) breach, client, debt type, owner, and priority. You must have the Complaints Panel Permission.

Suspension of collection activity

Latitude places a hold on accounts with complaints, which suspends all collection activity. When you close a complaint and no other active complaints exist on the account, Latitude removes the account hold and collection activity resumes.

Add a Complaint

Use the **Add Complaint** dialog box to add a complaint for the account.

To add a complaint

1. In the **Task Panel** navigation tree, click **Complaints**.

Id	Received	Closed	Owner	Category	Summary	Investigation	Conclusion	
1121	30/03/2016			Harassment	Complaint Id	1121	Date Received	30/03/2016
58	11/12/2015	14/12/2015		Balance Related	Document Id		Priority	1

Status:

Category:

Type:

Dissatisfaction:

Grievances:

SLA Days Remaining:

SLA Days:

Date Processed:



Referred By:

Complaint Details:

2. Under the data grid, click **Add**.

Add Complaint

▼ Summary

Document Id	<input type="text"/>	Date Received	<input type="text"/> 	Date Processed	<input type="text"/> 
Owner	<input type="text"/>	Priority	<input type="text" value="0"/>	Referred By	<input type="text"/>
Status	<input type="text" value="Unknown"/>	SLA Days Remaining	<input type="text" value="0"/>		
Category	<input type="text" value="Unknown"/>	SLA Days	<input type="text" value="0"/>		
Type	<input type="text" value="Unknown"/>	Complaint Details	<input type="text"/>		
Dissatisfaction	<input type="checkbox"/>				
Grievances	<input type="text"/>				

▼ Investigation

Complaint Against Type	<input type="text"/>	Complaint Against	<input type="text"/>
Investigation To Date	<input type="text"/>		

▼ Conclusion

Complaint Outcome	<input type="text"/>	Complaint Justified	<input type="text"/>
Root Cause	<input type="text"/>	Recourse Date	<input type="text"/>
Conclusion	<input type="text"/>		Compensation <input type="text" value="£"/>

Tip: To collapse or expand a section, click the section title.

Summary

Document ID: Code that identifies the document to associate to the complaint.

Owner: Complaint department staff assigned to the complaint.

Status: Status of the complaint.

Category: Complaint category, such as branch or department.

Type: Type of complaint, such as human or system error.

Dissatisfaction: If selected, the customer is dissatisfied.

Grievances: List of the customer's grievances.

Date Received: Date your organization received the complaint. If an inbound document generated the complaint, ECMS populates this date. Otherwise, you populate it.

Priority: Priority level that determines when the Complaint Department works the complaint. Latitude populates this box.

SLA Days Remaining: Number of days remaining until you breach the Service Level Agreement (SLA). Latitude subtracts the complaint received date from the current date to calculate this value.

SLA Days: Number of days after receiving the complaint that you have to resolve it before breaching the SLA. Latitude populates this box.

Complaint Details: Details regarding the complaint.

Date Processed: Date your organization processed the complaint.

Referred By: Person who referred the complaint, such as third party, client, or user.

Investigation

Complaint Against Type: Category for who or what the complaint is against, such as third party, branch, department, or user.

Investigation to Date: Information regarding the complaint investigation from the beginning to the current date.

Complaint Against: Who or what the complaint is against. The values available are based on the complaint type selected.

Conclusion

Complaint Outcome: Outcome of the complaint, such as training required or disciplinary action.

Root Cause: Root cause of the complaint.

Conclusion: Based on the investigation, the conclusion regarding the complaint.

Complaint Justified: Indicates whether the complaint is justified.

Recourse Date: Recourse approval date.

Compensation Amount: Amount of compensation the customer received.

3. Complete the information and then click **Save**.

Modify a Complaint

Use the **Edit Complaint** dialog box to modify a complaint for the account.

To modify a complaint

1. In the **Task Panel** navigation tree, click **Complaints**.

Id	Received	Closed	Owner	Category	Summary	Investigation	Conclusion	
1121	30/03/2016			Harassment	Complaint Id	1121	Date Received	30/03/2016
58	11/12/2015	14/12/2015		Balance Related	Document Id		Priority	1
<input type="button" value="+ Add"/> <input type="button" value="Edit"/> <input type="button" value="Help"/>					Owner		SLA Days Remaining	53
<input type="button" value="Previous"/> <input type="button" value="1"/> <input type="button" value="Next"/>					Status	Await External Comi	SLA Days	56
					Category	Harassment	Date Processed	01/04/2016
					Type	Human Error	Referred By	3rd party
					Dissatisfaction	<input type="checkbox"/>	Complaint Details	
					Grievances			
					<input type="button" value="Select Accounts"/> <input type="button" value="Close Complaint"/> <input type="button" value="Existing Complaint"/> <input type="button" value="Incorrect Account"/> <input type="button" value="Not a Complaint"/>			

2. In the data grid, click the complaint and then click **Edit**.

Edit Complaint

▼ Summary

Complaint Id	<input type="text" value="1058"/>	Date Received	<input type="text" value="22/09/2014"/>	Date Processed	<input type="text" value="23/09/2014"/>
Owner	<input type="text"/>	Priority	<input type="text" value="0"/>	Referred By	<input type="text" value="3rd party"/>
Status	<input type="text" value="Unknown"/>	SLA Days Remaining	<input type="text" value="-42"/>		
Category	<input type="text" value="Unknown"/>	SLA Days	<input type="text" value="0"/>		
Type	<input type="text" value="Unknown"/>	Complaint Details	<input type="text"/>		
Dissatisfaction	<input type="checkbox"/>				
Grievances	<input type="text"/>				

▼ Investigation

Complaint Against Type	<input type="text"/>	Complaint Against	<input type="text"/>
Investigation To Date	<input type="text"/>		

▼ Conclusion

Complaint Outcome	<input type="text"/>	Complaint Justified	<input type="text"/>
Root Cause	<input type="text"/>	Date Closed	<input type="text"/>
Conclusion	<input type="text"/>	Recourse Date	<input type="text"/>

Help

Tip: To collapse or expand a section, click the section title.

Summary

Complaint ID: Unique code that Latitude assigns to identify the complaint.

Owner: Complaint Department staff assigned to the complaint.

Status: Status of the complaint.

Category: Complaint category, such as branch or department.

Type: Type of complaint, such as human or system error.

Dissatisfaction: If selected, the customer is dissatisfied.

Grievances: List of the customer's grievances.

Date Received: Complaint received date. If an inbound document generated the complaint, ECMS populates this date. Otherwise, you populate it.

Priority: Priority in which the Complaint Department works the complaint. Latitude populates this box.

SLA Days Remaining: Number of days remaining until you breach the Service Level Agreement (SLA). Latitude subtracts the complaint received date from the current date to calculate this value.

SLA Days: Number of days after receiving the complaint that you have to resolve it before breaching the SLA. Latitude populates this box.

Complaint Details: Details regarding the complaint.

Date Processed: Date your organization processed the complaint.

Referred By: Person who referred the complaint, such as third party, Capquest, client, or user.

Investigation

Complaint Against Type: Category for who or what the complaint is against, such as third party, branch, department, or user.

Investigation to Date: Information regarding the complaint investigation from the beginning to the current date.

Complaint Against: Who or what the complaint is against. The values available are based on the complaint type selected.

Conclusion

Complaint Outcome: Outcome of the complaint, such as training required or disciplinary action.

Root Cause: Root cause of the complaint.

Conclusion: Based on the investigation, the conclusion regarding the complaint.

Complaint Justified: Indicates whether the complaint is justified.

Date Closed: Complaint closed date. When you specify the complaint outcome. Latitude populates this box with the current date.

Recourse Date: Recourse approval date.

Compensation Amount: Amount of compensation the customer received.

3. Modify the information and then click **Save**.

Select Accounts to Associate to the Complaint

Use the **Complaints** panel to associate other accounts to the complaint. Only linked accounts are available for selection. You can view the complaint from any account associated to it.

To select accounts to associate to the complaint

1. In the **Task Panel** navigation tree, click **Complaints**.

Id	Received	Closed	Owner	Category	Summary	Investigation	Conclusion	
1121	30/03/2016			Harassment	Complaint Id	1121	Date Received	30/03/2016
58	11/12/2015	14/12/2015		Balance Related	Document Id		Priority	1
					Owner		SLA Days Remaining	53
					Status	Await External Com	SLA Days	56
					Category	Harassment	Date Processed	01/04/2016
					Type	Human Error	Referred By	3rd party
					Dissatisfaction	<input type="checkbox"/>	Complaint Details	
					Grievances			

2. In the data grid, click the complaint to associate accounts to and then click **Select Accounts**.

Select Accounts

Client Ref #	Client Code	Balance	Include
1000	CUSTOMER ONE	\$967.47	<input type="checkbox"/>
1201	CUSTOMER ONE	\$250.00	<input type="checkbox"/>

3. Select one or more accounts to associate and then click **Save**.

Remove a Duplicate Complaint

Use the **Complaints** panel to remove a duplicate complaint for the account.

To remove a duplicate complaint

1. In the **Task Panel** navigation tree, click **Complaints**.

Id	Received	Closed	Owner	Category	Summary	Investigation	Conclusion	
1121	30/03/2016			Harassment	Complaint Id	1121	Date Received	30/03/2016
58	11/12/2015	14/12/2015		Balance Related	Document Id		Priority	1

Status:
 Category:
 Type:
 Dissatisfaction:
 Grievances:

SLA Days Remaining:
 SLA Days:
 Date Processed:
 Referred By:
 Complaint Details:

2. In the data grid, click the duplicate complaint to remove and then click **Existing Complaint**. Latitude removes the complaint.

Remove a Complaint From an Account

Use the **Complaints** panel to remove a complaint from the account.

To remove a complaint

1. In the **Task Panel** navigation tree, click **Complaints**.

Id	Received	Closed	Owner	Category	Summary	Investigation	Conclusion	
1121	30/03/2016			Harassment	Complaint Id	1121	Date Received	30/03/2016
58	11/12/2015	14/12/2015		Balance Related	Document Id		Priority	1

Status:
 Category:
 Type:
 Dissatisfaction:
 Grievances:

SLA Days Remaining:
 SLA Days:
 Date Processed:
 Referred By:
 Complaint Details:

- In the data grid, click the complaint to remove and then click **Incorrect Account**. Latitude removes the complaint from the account.

Remove a Non-Complaint Document

Use the **Complaints** panel to remove a document that isn't a complaint document from the account.

To remove a non-complaint document

- In the **Task Panel** navigation tree, click **Complaints**.

Id	Received	Closed	Owner	Category	Summary	Investigation	Conclusion	
1121	30/03/2016			Harassment	Complaint Id	1121	Date Received	30/03/2016
58	11/12/2015	14/12/2015		Balance Related	Document Id		Priority	1
					Owner		SLA Days Remaining	53
					Status	Await External Comi	SLA Days	56
					Category	Harassment	Date Processed	01/04/2016
					Type	Human Error	Referred By	3rd party
					Dissatisfaction	<input type="checkbox"/>	Complaint Details	
					Grievances			

- In the data grid, click the complaint to remove and then click **Not a Complaint**. Latitude removes the complaint from the account and sends a message to ECMS that includes the document ID that created the complaint.

Close a Complaint

Use the **Complaints** panel to close a complaint for the account. If you specify a complaint outcome. Latitude closes the complaint automatically.

To close a complaint

- In the **Task Panel** navigation tree, click **Complaints**.

Id	Received	Closed	Owner	Category	Summary	Investigation	Conclusion	
1121	30/03/2016			Harassment	Complaint Id	1121	Date Received	30/03/2016
58	11/12/2015	14/12/2015		Balance Related	Document Id		Priority	1
					Owner		SLA Days Remaining	53
					Status	Await External Comi	SLA Days	56
					Category	Harassment	Date Processed	01/04/2016
					Type	Human Error	Referred By	3rd party
					Dissatisfaction	<input type="checkbox"/>	Complaint Details	
					Grievances			

- In the data grid, click the complaint to close and then click **Close Complaint**. If you didn't specify an outcome, an error message appears. Close the dialog box, specify an outcome, and then click **Close Complaint**.

Reopen a Complaint

Use the **Complaints** panel to reopen a closed complaint for the account.

To reopen a complaint

1. In the **Task Panel** navigation tree, click **Complaints**.

The screenshot shows the Complaints panel interface. On the left is a data grid with columns: Id, Received, Closed, Owner, and Category. The second row is highlighted in orange, showing Id 58, Received 11/12/2015, Closed 14/12/2015, and Category Balance Related. Below the grid are '+ Add' and 'Help' buttons, and a pagination control showing 'Previous 1 Next'. To the right is a form with tabs for Summary, Investigation, and Conclusion. The form contains various fields: Complaint Id (58), Date Received (11/12/2015), Document Id, Priority (1), SLA Days Remaining (52), SLA Days (56), Date Processed (11/12/2015), Referred By (Customer), and a text area for Complaint Details. At the bottom of the form are buttons: 'Select Accounts', 'ReOpen' (highlighted in orange), 'Existing Complaint', 'Incorrect Account', and 'Not a Complaint'.

2. In the data grid, click the closed complaint to reopen and then click **ReOpen**.

Disputes

Disputes

Use the **Disputes** panel to add, modify, and complete debt disputes for accounts. An account can have multiple disputes, including concurrent active ones. You or the system can move disputed accounts to a pending dispute work queue for further processing. You must have the Disputes Panel Permission.

Suspension of collection activity

Latitude places a hold on accounts in dispute to suspend all collection activity. When you close a dispute and no other active disputes exist on the account, Latitude removes the account hold and collection activity resumes.

Suspension of interest calculation

Latitude suspends interest calculation for disputed accounts with interest charges on their account balances. When you close a dispute and no other active disputes exist on the account, Latitude resumes interest calculations.

Add a Dispute

Use the **Add Dispute** dialog box to add a dispute for the account.

To add a dispute

1. In the **Task Panel** navigation tree, click **Disputes**.

The screenshot shows the 'Add Dispute' dialog box. It features a data grid on the left with columns: Dispute ID, Received, Closed, Document, and Category. The first row is highlighted in orange, showing Dispute ID 1, Received 6/25/18, and Category Interest & Charges. Below the grid are '+ Add', 'Edit', and 'Help' buttons, and a pagination control showing 'Previous 1 Next'. To the right is a form with fields: Dispute ID (1), Document (None), Dispute Type (PART BALANCE), Date Received (6/25/18), Date Closed, Dispute relates to (Client), Category (Interest & Charges), Referred By (Third Party), Recourse Date, Justified (In Part), Dispute Details (Text), and Outcome (Proof Required, Proof Requested, Insufficient Proof Received, Proof Received). At the bottom of the form are buttons: 'Close Dispute' (highlighted in orange), 'Existing Dispute', and 'Not a Dispute'.

2. Click **Add**.

Add Dispute

Dispute ID	<input type="text"/>	Category	<input type="text"/>	Outcome	<input type="text"/>
Document	<input type="text" value="None"/>	Referred By	<input type="text"/>	<input type="checkbox"/> Proof Required	
Dispute Type	<input type="text"/>	Recourse Date	<input type="text"/>	<input type="checkbox"/> Proof Requested	
Date Received	<input type="text" value="4/16/20"/>	Justified	<input type="text"/>	<input type="checkbox"/> Insufficient Proof Received	
Date Closed	<input type="text"/>	Dispute Details	<input type="text"/>	<input type="checkbox"/> Proof Received	
Dispute Against	<input type="text"/>				

Dispute ID: Unique code that Latitude assigns to identify the dispute.

Document: Unique code that identifies the document associated to the dispute.

Dispute Type: Type of dispute, such as possible fraud or incorrect trace.

Date Received: Dispute received date.

Date Closed: Dispute closed date. When you close the dispute. Latitude populates this box with the current date.

Dispute Against: Person that the dispute is against, such as client or third party.

Category: Dispute category, such as fraud or wrong trace.

Referred By: Person who referred the dispute, such as a third party or the client.

Recourse Date: Recourse approval date.

Justified: Indicates whether the dispute is justified.

Dispute Details: Details regarding the dispute.

Outcome: Outcome of the dispute, such as account on hold or unable to resolve.

Proof Required: If selected, your organization requires proof of the dispute.

Proof Requested: If selected, your organization requested proof of the dispute.

Insufficient Proof Received: If selected, your organization received proof that is insufficient.

Proof Received: If selected, your organization received proof of the dispute.

3. Complete the information and then click **Save**.

Modify a Dispute

Use the **Edit Dispute** dialog box to modify a dispute for the account.

To modify a dispute

1. In the **Task Panel** navigation tree, click **Disputes**.

Dispute ID	Received	Closed	Document	Category
1	6/25/18			Interest & Charges

Dispute ID: 1
 Document: None
 Dispute Type: PART BALANCE
 Date Received: 6/25/18
 Date Closed:
 Dispute relates to: Client

Category: Interest & Charges
 Referred By: Third Party
 Recourse Date:
 Justified: In Part
 Dispute Details: Test

Outcome:

- Proof Required
- Proof Requested
- Insufficient Proof Received
- Proof Received

- In the data grid, click the dispute and then click **Edit**.

Edit Dispute

Dispute ID:
 Category:
 Outcome:

Document:
 Referred By:

Dispute Type:
 Recourse Date:

Date Received:
 Justified:

Date Closed:
 Dispute Details:

Dispute Against:

Dispute ID: Unique code that Latitude assigns to identify the dispute.

Document: Unique code that identifies the document associated to the dispute.

Dispute Type: Type of dispute, such as possible fraud or incorrect trace.

Date Received: Dispute received date.

Date Closed: Dispute closed date. When you close the dispute. Latitude populates this box with the current date.

Dispute Against: Person that the dispute is against, such as client or third party.

Category: Dispute category, such as fraud or wrong trace.

Referred By: Person who referred the dispute, such as third party, client, or user.

Recourse Date: Recourse approval date.

Justified: Indicates whether the dispute is justified.

Dispute Details: Details regarding the dispute.

Outcome: Outcome of the dispute, such as account on hold or unable to resolve.

Proof Required: If selected, your organization requires proof of the dispute.

Proof Requested: If selected, your organization requested proof of the dispute.

Insufficient Proof Received: If selected, your organization received proof that is insufficient.

Proof Received: If selected, your organization received proof of the dispute.

- Modify the information and then click **Save**.

Remove a Duplicate Dispute

Use the **Disputes** panel to remove a duplicate dispute for the account.

To remove a duplicate dispute

1. In the **Task Panel** navigation tree, click **Disputes**.

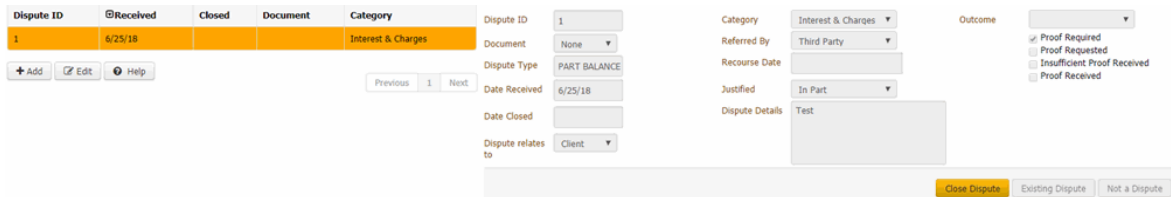

2. In the data grid, click the duplicate dispute to remove and then click **Existing Dispute**. Latitude removes the dispute.

Remove a Non-Dispute Document

Use the **Disputes** panel to remove a document that isn't a dispute document from the account.

To remove a non-dispute document

1. In the **Task Panel** navigation tree, click **Disputes**.

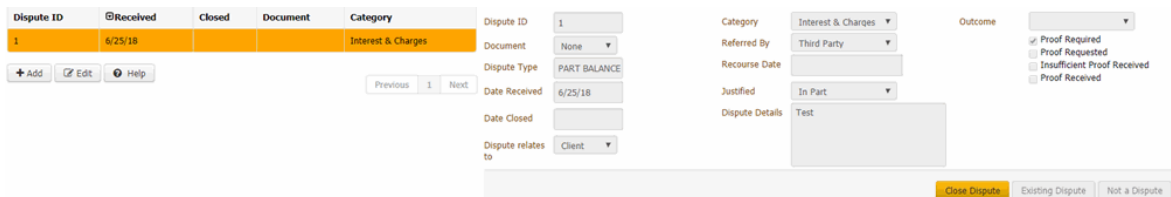

2. In the data grid, click the dispute to remove and then click **Not a Dispute**. Latitude removes the dispute from the account.

Close a Dispute

Use the **Disputes** panel to close a dispute for the account.

To close a dispute

1. In the **Task Panel** navigation tree, click **Disputes**.

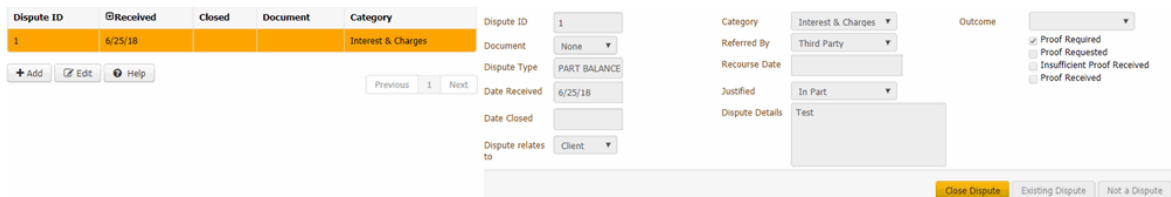

2. In the data grid, click the dispute to close and then click **Close Dispute**.

Reopen a Dispute

Use the **Disputes** panel to reopen a closed dispute for the account.

To reopen a dispute

1. In the **Task Panel** navigation tree, click **Disputes**.

Dispute ID	Received	Closed	Document	Category
74	04/04/2016	04/04/2016		Interest & Charges

Dispute ID	74	Category	Interest & Charges	Outcome	
Document		Referred by	Capquest		<input type="checkbox"/> Proof Required <input type="checkbox"/> Proof Requested <input type="checkbox"/> Insufficient Proof Received <input type="checkbox"/> Proof Received
Dispute Type	Part Balance	Recourse Date			
Date Received	04/04/2016	Justified	Yes		
Date Closed	04/04/2016	Dispute Details			
Dispute relates to	Third Par				

[ReOpen](#)

- In the data grid, click the closed dispute to reopen and then click **Reopen**.

RDN Integration

RDN Integration

Use the **RDN Integration** panel to create and update vehicle recovery cases for the account. This panel integrates with the Recovery Database Network (RDN) system to allow the exchange of recovery data.

After you create a case and assign it to a recovery agency, a recovery agent begins the process of locating and repossessing the piece of collateral. During the process, the agent updates their progress in the RDN system. Latitude retrieves the updates from the RDN system when you choose the update option in Latitude. If your organization created a job in Job Manager to retrieve updates, Job Manager retrieves updates for all RDN cases for all Latitude accounts during the scheduled job run and posts the updates to Latitude.

View Summary Data for an RDN Case

Use the **RDN Integration** panel to view summary data for an RDN case.

To view summary data for an RDN case

- In the **Task Panel** navigation tree, click **RDN Integration** and then click the **Summary** tab.

Summary	47 New autos 2070185356	48 Used autos 2070185490	46 Recreational vehicle 2070185630		
Debtor:	Richard Debtor Middle Name Kile	Co-Debtor:	Co-Debtor First Name Co-Debtor Middle Name Co-Debtor Last Name		
SSN:		SSN:			
DOB:	12/31/1752	DOB:			
<input type="checkbox"/> Use address on account	Address: Address Line 1 Address Line 2 City Select a State Zip Code	<input type="checkbox"/> Use address on account	Address: Address Line 1 Address Line 2 City Select a State Zip Code		
Phone:	H: - M: -	Phone:	H: - M: -		
Case #	Collateral	Order Type	Status	Last Update	Message
2070185356	47 New autos	LPR Staging	PendingOnHold	11/12/2019 5:24:59 PM	Your client has requested that this account be placed on hold for the following reason: Customer Promised to Pay Current
2070185490	48 Used autos	Repossess	Pending Close	11/6/2019 5:11:53 AM	Your client has requested that this account be closed for the following reason: jhj
2070185630	46 Recreational vehicle	Investigate/Repo	Pending Close		

[Create Case](#)
[Get Updates](#)
[Help](#)

Debtor: Debtor's first name, middle name, and last name.

SSN: Debtor's Social Security Number.

DOB: Debtor's date of birth.

Use address on account: If selected, Latitude populates the address boxes with the default address on the account and makes the address boxes unavailable for edit.

Address: Debtor's street address, city, state, and postal code. If you selected the **Use address on account** check box, you cannot modify the address unless you clear the check box. Changes to the address on this tab does not change the address on the account.

Phone: Debtor's home and mobile phone numbers.

Co-Debtor: Co-debtor's first name, middle name, and last name.

SSN: Co-debtor's Social Security Number.

DOB: Co-debtor's date of birth.

Use address on account: If selected, Latitude populates the address boxes with the default address on the account and changes the address boxes to unavailable for edit.

Address: Co-debtor's street address, city, state, and postal code. If you selected the **Use address on account** check box, you cannot modify the address unless you clear the check box. Changes to the address on this tab does not change the address on the account.

Phone: Co-debtor's home and mobile phone numbers.

If there are open RDN cases for the account, the following data appears in a data grid.

Case #: Number that the RDN system assigned to identify the case.

Collateral: Name of the collateral item.

Order Type: Type of recovery order.

Status: Status of the recovery order.

Last Update: Date that the case was updated in the RDN system.

Message: Details about the RDN case update.

View RDN Case Detail and Update History

Use the **Case Details** and **Update History** tabs on the **RDN Integration** panel to view details and update history for an RDN case.

To view RDN case detail and update history

1. In the **Task Panel** navigation tree, click **RDN Integration**, click the tab for the case to view, and then click the **Case Details** tab.

Arrangements	Summary	2017 GMC 2500 Sierra Denal 2070211618			
Case and Financial Hardship	Case Details	Update History			
Complaints	Case ID	2070211618	Order Type	Repossess	Sub Status
Customer	Status	New From Client			
Disputes	Agent Information				
Legal - New Court Case	Name	New Test Rapo Company3	State License Number	Lpr2 Assignments <input type="checkbox"/>	
Letters	Phone	4805779374	Memberships		
RDN Integration	Collateral				
	Year	2020	Make	2017 GMC 2500 Sierra Den	Color
	Model	See Equipment Schedule	State		License#
	VIN#	1GT12UEY3HF236297521			
	Debtor Address		Co-Debtor Address		
	<input type="checkbox"/> Use address on account		<input type="checkbox"/> Use address on account		
	Address: 112 ANDERSON ROAD		Address: Address Line 1		
	Address Line 2		Address Line 2		
	COVINGTON		City		
	LA 70433		Select a State Zip Code		
	Phone: H: 8102922911		Phone: H:		
	M:		M:		
	<input type="button" value="Send Update"/> <input type="button" value="Hold"/> <input type="button" value="Close"/> <input type="button" value="Close and Reassign"/> <input type="button" value="Help"/>				

Case ID: Number that the RDN system assigned to identify the case.

Status: Status of the recovery order.

Order Type: Type of recovery order.

Sub Status: Secondary status of the order.

Agent Information

Name: Name of the repossession agent.

Phone: Repossession agent's phone number.

State License Number: Repossession agent's state license number.

Memberships: Associations for which the repossession agent has a membership.

Lpr2 Assignments: If selected, the agency is only used for LPR assignments.

Collateral

Year: Vehicle model year.

Model: Vehicle model.

VIN: Vehicle Identification Number.

Make: Vehicle manufacturer.

State: State where the vehicle is licensed.

Color: Color of the vehicle.

License #: Vehicle's license plate number.

Debtor Address

Use Address on Account: If selected, uses the address on the account, instead of the one specified on this tab.

Address: Debtor's street address line 1, street address line 2, city, state, and postal code.

Phone: Debtor's home and mobile phone numbers.

Co-Debtor Address

Use Address on Account: If selected, uses the address on the account, instead of the one specified on this tab.

Address: Co-debtor's street address line 1, street address line 2, city, state, and postal code.

Phone: Co-debtor's home and mobile phone numbers.

2. Click the **Update History** tab.

Date	Priority	Message
4/15/2020 7:17:24 AM	Default	updated debtor address

Date: Date that the case was updated in the RDN system.

Priority: RDN case update priority.

Message: Details about the RDN case update.

Create an RDN Case

Use the **Create Case** dialog box to create an RDN repossession case for a piece of collateral for which there is no case currently. You can only create one case for each piece of collateral. If all pieces of collateral have a case, the option to create a case is not available. You must have the Allow RDN Case Creation and Updates Permission.

To create an RDN case

1. In the **Task Panel** navigation tree, click **RDN Integration**.

Summary | 47 New autos 2070185356 | 48 Used autos 2070185490 | 46 Recreational vehicle 2070185630

Debtor: Richard
Debtor Middle Name
Kile

Co-Debtor: Co-Debtor First Name
Co-Debtor Middle Name
Co-Debtor Last Name

SSN:
DOB: 12/31/1752

Use address on account Address: Address Line 1
Address Line 2
City
Select a State Zip Code

Phone: H: M:

Case #	Collateral	Order Type	Status	Last Update	Message
2070185356	47 New autos	LPR Staging	PendingOnHold	11/12/2019 5:24:59 PM	Your client has requested that this account be placed on hold for the following reason: Customer Promised to Pay Current
2070185490	48 Used autos	Repossess	Pending Close	11/6/2019 5:11:53 AM	Your client has requested that this account be closed for the following reason: jhjhj
2070185630	46 Recreational vehicle	Investigate/Repo	Pending Close		

Create Case Get Updates Help

Latitude populates the debtor and, if applicable, co-debtor boxes.

2. Modify the debtor and co-debtor information as necessary. Latitude does not change the debtor and co-debtor information on the account. The changes on this tab are for the RDN system only.
3. Do one of the following:
 - To use the address on the account, select the **Use address on account** check box. Latitude populates the address boxes with the default address on the account and makes the address boxes unavailable for edit.
 - To specify an address other than the one on the account, clear the **Use address on account** check box and then complete the address boxes. Latitude does not change the address on the account. The changes on this tab are for the RDN system only.
4. To specify phone numbers, complete the phone number boxes.
5. Click **Create Case**.

Create New Case

Select Collateral

Alternate Address Address Line 1
Address Line 2
City
Select a State Zip Code

Additional Information

Select Zip Code

Order Type

Submit Order Cancel Help

6. In the **Select Collateral** list box, click the piece of collateral to assign to the case. The list only contains collateral that isn't associated to a case currently.
7. (Optional) In the **Alternate Address** boxes, specify an alternate address where the recovery agent might find the piece of collateral. Or, you can specify the agent's business address.

Latitude Printable Help

8. (Optional) In the **Additional Information**, type other information regarding the case.
9. Do the following:
 - a. In the **Select Zip Code** box, type the ZIP code in which to search for a recovery agency and then click the Search icon. The agencies located in that ZIP code appear in the data grid.

Create New Case

Select Collateral: 47 New autos

Alternate Address: Address Line 1, Address Line 2, City, Select a State, Zip Code

Additional Information: Test

Select Zip Code: 85204 [Search]

Agent Name	Agent Address	AgentPhone
Latitude - Test Company	1620 S Stapley	5403218585
New Test Repo Company	1620 S Stapley Dr	4805779372
New Test Repo Company2	1620 S Stapley Dr	4805779373
New Test Repo Company3	1620 S stapley Dr	4805779374

Order Type: Transport

Submit Order Cancel Help

- b. In the data grid, click the agency to assign to the case.
10. In the **Order Type** list box, click the type of order requested, such as vehicle transport or repossession.
11. Click **Submit Order**. Latitude sends the recovery order to the RDN system. If sent successfully, RDN sends the case information to the agent and Latitude adds a tab to the **RDN Integration** panel for the case.

Modify Addresses and Phone Numbers on an RDN Case

Use the **Case Details** tab on the **RDN Integration** panel to modify debtor and co-debtor addresses and phone numbers on an RDN case.

To modify addresses and phone numbers on an RDN case

1. In the **Task Panel** navigation tree, click **RDN Integration**, click the tab for the case to modify, and then click the **Case Details** tab.

Update Priority: Urgency of the update for the recovery agent or agency.

Update Type: Type of update to send to RDN, such as account closed or address update.

Update Text: More information about the update.

Update Collateral?: If selected, you want to send collateral changes in Latitude to the RDN system. For more information about what data Latitude includes, see [Case Updates](#).

Update Address?: If selected, you want to send address changes in Latitude to the RDN system.

Update Account Info?: If selected, you want to send account information changes in Latitude to the RDN system.

Note: Latitude doesn't update the RDN system automatically when you update collateral, address, or account information in Latitude. You must send an update to the RDN system.

3. Complete the information and ensure that you select the **Update Address?** check box.
4. click **Submit**. Latitude sends the updates to the RDN system and displays a message indicating such.
5. Click **Close**. Latitude adds a message to the **Recent Updates** data grid on the **Case Details** tab. Latitude also adds a row to the data grid on the **Summary** tab and includes a message about the update.

Retrieve Case Updates From RDN

Use the **Get Update** option to retrieve status updates from the RDN system in real time for all the cases on the account. You must have the Allow RDN Case Creation and Updates Permission.

Note: If your organization created a job in Job Manager to retrieve status updates, Job Manager retrieves updates for all RDN cases for all Latitude accounts when the scheduled job runs.

To retrieve case updates from RDN

1. In the **Task Panel** navigation tree, click **RDN Integration**.

Summary	47 New autos 2070185356	48 Used autos 2070185490	46 Recreational vehicle 2070185630
Debtor:	Richard Debtor Middle Name Kile	SSN: DOB: 12/31/1752	Co-Debtor: Co-Debtor First Name Co-Debtor Middle Name Co-Debtor Last Name
SSN:		DOB:	
Use address on account	Address: Address Line 1 Address Line 2 City Select a State Zip Code	Use address on account	Address: Address Line 1 Address Line 2 City Select a State Zip Code
Phone:	H: M:	Phone:	H: M:

Case #	Collateral	Order Type	Status	Last Update	Message
2070185356	47 New autos	LPR Staging	PendingOnHold	11/12/2019 5:24:59 PM	Your client has requested that this account be placed on hold for the following reason: Customer Promised to Pay Current
2070185490	48 Used autos	Repossess	Pending Close	11/6/2019 5:11:53 AM	Your client has requested that this account be closed for the following reason: jhjhj
2070185630	46 Recreational vehicle	Investigate/Repo	Pending Close		

Create Case Get Updates Help

2. Click **Get Update**. Latitude retrieves the latest case status for each open case on the account from the RDN system and displays a message indicating such.
3. Click **Close**.

Send a Case Update to RDN

Use the **Send Update** option to send updates from Latitude to the RDN system in real time for a specific case on the account.

Note: You can only send updates for cases that aren't on hold or closed.

To send a case update to RDN

1. In the **Task Panel** navigation tree, click **RDN Integration** and then click the tab for the case for which to send an update.

Summary	2017 GMC 2500 Sierra Denal 2070211618		
Case Details	Update History		
Case ID	2070211618	Order Type	Repossess
Status	New From Client	Sub Status	
Agent Information	Name: New Test Repo Company3	State License Number	Lpr2 Assignments
Phone	4805779374	Memberships	
Collateral	Year: 2020	Make: 2017 GMC 2500 Sierra Den	Color
Model	See Equipment Schedule	State	License#
VIN#	1GT12UEY3HF236297521		
Debtor Address	Co-Debtor Address		
Use address on account	Use address on account		
Address: 112 ANDERSON ROAD	Address: Address Line 1		
Address Line 2	Address Line 2		
COVINGTON	City		
LA 70433	Select a State Zip Code		
Phone: H: 6102922911	Phone: H:		
M:	M:		

Send Update Hold Close Close and Reassign Help

2. Click **Send Update**.

The screenshot shows a 'Send Update' dialog box with the following elements:

- Update Priority:** A dropdown menu with the text 'Select a Priority'.
- Update Type:** A dropdown menu with the text 'Select an Update Type'.
- Update Text:** A large, empty text area.
- Update Collateral?:** A checked checkbox.
- Update Address?:** A checked checkbox.
- Update Account Info?:** A checked checkbox.
- Buttons:** 'Submit' (yellow), 'Cancel', and 'Help' (with a question mark icon).

Update Priority: Urgency of the update for the recovery agent or agency.

Update Type: Type of update to send to RDN, such as account closed or address update.

Update Text: More information about the update.

Update Collateral: If selected, you want to send collateral changes in Latitude to the RDN system. For more information about what data Latitude includes, see [Case Updates](#).

Update Address: If selected, you want to send address changes in Latitude to the RDN system.

Update Account Info: If selected, you want to send account information changes in Latitude to the RDN system.

Note: Latitude doesn't update the RDN system automatically when you update collateral, address, or account information in Latitude. You must send an update to the RDN system.

3. Complete the information and then click **Submit**. Latitude sends the updates to the RDN system and displays a message indicating such.
4. Click **Close**. Latitude adds a message to the **Recent Updates** data grid on the **Case Details** tab. Latitude also adds a row to the data grid on the **Summary** tab and includes a message about the update.

Case Updates

If you select the **Update Collateral** check box in the **Send Update** dialog box, Latitude includes the following data when sending updates to the RDN system.

Collateral

- VIN
- Year
- Make
- Model

- Vehicle Color
- Vehicle License Number
- Vehicle License State
- Vehicle License Expiry
- Key Code 1
- Key Code 2
- Mileage

Account Info

- Amount Past Due
- Monthly Payments
- Balance on Account
- Delinquent Since
- Charge Off Date
- Bankruptcy Type

Address

- Address ID
- Address
- Address Type
- City
- State
- ZIP code
- Phones

Place an RDN Case on Hold

Use the **RDN Integration** panel to place an RDN case on hold to stop the recovery process temporarily. For example, you can place a case on hold while you investigate a customer's complaint.

To place an RDN case on hold

1. In the **Task Panel** navigation tree, click **RDN Integration** and then click the tab for the case to put on hold.

Latitude Printable Help

The screenshot shows the 'Case Details' tab for case 2070211618. The form is divided into several sections:

- Case Details:** Case ID (2070211618), Order Type (Repossess), Sub Status (empty), Status (New From Client).
- Agent Information:** Name (New Test Rapo Company3), State License Number (empty), Lpr2 Assignments (checkbox), Phone (4805779374), Memberships (empty).
- Collateral:** Year (2020), Make (2017 GMC 2500 Sierra Den), Color (empty), Model (See Equipment Schedule), State (empty), License# (empty), VIN# (1GT12UEY2HF236297521).
- Debtor Address:** Use address on account (checkbox), Address (112 ANDERSON ROAD, Address Line 2, COVINGTON, LA 70433), Phone (H: 8102922911, M: empty).
- Co-Debtor Address:** Use address on account (checkbox), Address (Address Line 1, Address Line 2, City, Select a State, Zip Code), Phone (H: empty, M: empty).

Buttons at the bottom: Send Update, Hold, Close, Close and Reassign, Help.

2. Click **Hold**.

Hold Case

The 'Hold Case' form contains the following fields:

- Case ID:** 2070185356
- Reason:** Select a Reason Type (dropdown menu)
- Other Reason:** Text input field
- Collector ID:** Text input field

Buttons at the bottom: Submit, Cancel, Help.

Case ID: Number that the RDN system assigned to identify the case.

Reason: Reason for placing the case on hold.

Other Reason: Comments regarding the reason for placing the case on hold.

Collector ID: Code that identifies the user who's placing the case on hold.

3. Complete the information and then click **Submit**. Latitude sends the hold request to the RDN system. If sent successfully, the RDN system notifies the agent to stop the recovery process. Latitude places the case on hold and displays a message indicating such.
4. Click **Close**. Latitude adds a message to the **Recent Updates** data grid on the **Case Details** tab. Latitude also adds a row to the data grid on the **Summary** tab and includes a message about the hold.

Release the Hold on an RDN Case

Use the **RDN Integration** panel to release the hold on an RDN case after resolving the hold reason.

To release the hold on an RDN case

1. In the **Task Panel** navigation tree, click **RDN Integration** and then click the tab for the case for which to release the hold.

The screenshot displays the 'Case Details' tab for case ID 2070185859. The case is currently 'Pending On Hold'. The agent is 'New Test Repo Company2'. The collateral is a 2019 Toyota ABC, Red, AL, VIN# 123456789. The 'Recent Updates' table shows a history of actions, including requests to place the account on hold and to be taken off hold.

Date	Priority	Message
12/11/2019 1:12:14 PM	Default	Your client has requested that this account be placed on hold for the following reason: Other
12/11/2019 11:56:27 AM	Default	Your client has requested that this account be taken off hold
12/11/2019 11:56:20 AM	Default	Your client has requested that this account be placed on hold for the following reason: Customer Promised to Pay Current
12/6/2019 9:13:18 AM	Default	Your client has requested that this account be taken off hold
12/6/2019 9:13:02 AM	Default	Your client has requested that this account be placed on hold for the following reason: Customer Promised to Pay Current
12/5/2019 4:03:10 PM	Low	Sending updated info from Arvest
12/5/2019 3:56:45 PM	Default	Test
11/29/2019 11:37:28 AM	Default	Client updated collateral information
11/29/2019 11:37:16 AM	High	Collateral has been updated
11/29/2019 11:27:25 AM	Default	Blank Test

2. Click **Release**. Latitude sends the release request to the RDN system. If sent successfully, the RDN system notifies the agent to resume the recovery process. Latitude removes the hold and displays a message indicating such. You cannot send case updates until you release the hold.
3. Click **Close**. Latitude adds a message to the **Recent Updates** data grid on the **Case Details** tab. Latitude also adds a row to the data grid on the **Summary** tab and includes a message about the hold removal.

Note: If your research determined that recovery is no longer necessary, close the case after releasing it so that the RDN system notifies the agent to discontinue the recovery process. For more information, see [Close an RDN Case](#).

Close and Reassign an RDN Case

Use the **Reassign Case** dialog box to close a case with the current agent and reassign it to another agent. For example, if an agent fails to recover the piece of collateral within a specific time, the lienholder can close the case with that agent and reassign the case to another agent. Or, the piece of collateral is in a different area than originally thought so the case needs reassigned to an agent in the proper area.

Note: Before closing and reassigning a case, place the case on hold. Otherwise, the system displays an error.

To close and reassign an RDN case

1. In the **Task Panel** navigation tree, click **RDN Integration** and then click the tab for the case to close and reassign.

Latitude Printable Help

Summary	47 New autos 2070185513	47 New autos 2070185514	46 Recreational vehicle 2070185526	46 Recreational vehicle 2070185627	48 Used autos 2070185749
---------	-------------------------	-------------------------	------------------------------------	------------------------------------	--------------------------

Case Details

Case ID: 2070185627 Order Type: Repossess

Status: Pending On Hold Sub Status:

Agent Information

Name: New Test Repo Company2 Phone: 4805779373

State License Number: Lpr2 Assignments:

Memberships:

Collateral

Year: 0 Make: Toyota

Model: Corolla Color: blue

State: TN License#: 145add

VIN#: 1N0BR18E927627727

Buttons: Release, Close, Close and Reassign, Help

Recent Updates

Date	Priority	Message
11/11/2019 7:00:50 AM	Default	Your client has requested that this account be plac
11/11/2019 7:00:32 AM	Default	Your client has requested that this account be take
11/11/2019 6:58:20 AM	Default	Your client has requested that this account be plac
11/6/2019 8:04:08 PM	Default	Your client has requested that this account be take
11/6/2019 8:04:08 PM	Default	Case was accepted
11/6/2019 6:57:05 PM	Default	Your client has requested that this account be plac SomehugeTextSomehugeTextSomehugeTextSome

2. Click **Close and Reassign**.

Reassign Case

Select Zip Code:

Alternate Address: Address Line 1, Address Line 2, City, Select a State, Zip Code

Additional Information:

Order Type: Repossess

Buttons: Submit, Cancel, Help

3. Do the following:

- In the **Select Zip Code** box, type the ZIP code in which to search for a recovery agent and then click the Search icon. The agents located in that ZIP code appear in the data grid.

Reassign Case

Select Zip Code: 85204

Agent Name	Agent Address	AgentPhone
Latitude - Test Company	1620 S Stapley	5403218585
New Test Repo Company	1620 S Stapley Dr	4805779372
New Test Repo Company2	1620 S Stapley Dr	4805779373
New Test Repo Company3	1620 S stapley Dr	4805779374

Buttons: Previous, 1, Next

Alternate Address: 909 Test Ave, Address Line 2, City, Select a State, Zip Code

Additional Information: Test Info

Order Type: LPR Staging

Buttons: Submit, Cancel, Help

- In the data grid, click the agent to assign to the case.

- (Optional) In the **Alternate Address** boxes, specify an alternate address where the agent might find the piece of collateral, or specify the agent's business address. If you add or modify this information, Latitude updates it on the reassigned case.
- (Optional) In the **Additional Information**, type other information regarding the case. If you add or modify this information, Latitude updates it on the reassigned case.
- To change the pre-populated order type, in the **Order Type** list box, click the type of order requested, such as vehicle transport or repossession. If you modify this information, Latitude updates it on the reassigned case.
- Click **Submit Order**. Latitude sends the close and reassign case request to the RDN system. If sent successfully, RDN closes the case with the original agent and reassigns the case to the new agent. Latitude closes the original case and changes the case's tab to red to indicate that the case is closed. Then, Latitude adds a tab for the reassigned case.

Close an RDN Case

Use the **Close Case** dialog box to close an RDN case. For example, you close a case when the customer pays the account in full or the agent recovers the piece of collateral.

Note: If you placed a case on hold and then determined that recovery is no longer necessary, you must close the case after releasing it. Then, the RDN system can notify the agent to discontinue the recovery process.

To close an RDN case

- In the **Task Panel** navigation tree, click **RDN Integration** and then click the tab for the case to close.

The screenshot displays the Latitude RDN Integration interface. At the top, there is a navigation bar with several tabs: Summary, 47 New autos 2070185513, 47 New autos 2070185514, 46 Recreational vehicle 2070185626 (highlighted in red), 46 Recreational vehicle 2070185627, and 48 Used autos 2070185749. Below the navigation bar, the 'Case Details' section is visible, containing various input fields for Case ID, Status, Agent Information, Collateral, and Order Type. The 'Recent Updates' section on the right shows a list of messages with columns for Date, Priority, and Message.

Date	Priority	Message
11/15/2019 6:33:46 PM	Default	Your client has requested that this account be take
11/11/2019 7:00:50 AM	Default	Your client has requested that this account be plac
11/11/2019 7:09:32 AM	Default	Your client has requested that this account be take
11/11/2019 6:58:20 AM	Default	Your client has requested that this account be plac
11/6/2019 8:04:08 PM	Default	Your client has requested that this account be take
11/6/2019 8:04:08 PM	Default	Case was accepted
11/6/2019 6:57:05 PM	Default	Your client has requested that this account be plac SomehugeTextSomehugeTextSomehugeTextSome

- Click **Close**.

Latitude Printable Help

Close Case

Case ID

Reason

Other Reason

Collector ID

Case ID: Number that the RDN system assigned to identify the case.

Reason: Reason for closing the case.

Other Reason: Comments regarding case closure.

Collector ID: Code that identifies the user who's closing the case.

3. Complete the information and then click **Submit**. Latitude sends the close case request to the RDN system. If sent successfully, RDN closes the case with the agent. Latitude closes the case and changes the case's tab to red to indicate that the case is closed.

Reference Panels

Reference Panels

The **Reference** panels allow you to view reference information for an account. This section contains a **Reference Panel** navigation bar, which allows you to open the panels. Some panels also contain a toolbar with options for the selected panel. When you open a panel, a tab displays on the **Reference Panel** navigation bar (see the **Notes** tab in the following example). You can have multiple panels open at once and use the tabs to move between panels.

The **Notes** and **Interactions** panels are available to all users. The remaining panels available to you are based on how your organization configured the Reference Panels Permission.

The screenshot shows the Reference Panel navigation bar with tabs for 'Available Panels' and 'Notes'. Below the navigation bar is a toolbar with '+ Add Note', '+ Review Note', a search box, 'Joined Account' dropdown, 'Created By' dropdown, 'Clear Filters', and 'Help'. The main table displays a list of notes with columns: Date, Account, User, Action, Result, Comment, and Private?.

Date	Account	User	Action	Result	Comment	Private?
4/27/12 1:07 pm	1008	FUSION	SEND	SEND	Equifax FirstSearch Service data ordered on 04/27/2012. Current Balance = 476.55	<input type="checkbox"/>
4/27/12 1:07 pm	1005	FUSION	SEND	SEND	Equifax FirstSearch Service data ordered on 04/27/2012. Current Balance = 1307.21	<input type="checkbox"/>
2/11/11 10:13 am	1005	EXCHANGE-S	CO	CO	NEW BIZ IMPORT	<input type="checkbox"/>
2/11/11 10:13 am	1008	EXCHANGE-S	CO	CO	NEW BIZ IMPORT	<input type="checkbox"/>

Navigation: Previous 1 Next

Addresses

Addresses

Use the **Address** panel to view, add, and modify addresses associated to an account.

View Addresses

Use the **Address** panel to view the addresses associated to the account. You can filter the addresses that display based on one or more criteria.

To view addresses

1. In the **Reference Panel** navigation bar, click **Available Panels** and then click **Address**.

The screenshot shows the Address panel navigation bar with tabs for 'Available Panels', 'Income And Expenditure', and 'Address'. Below the navigation bar is a toolbar with '+ Add', 'Edit', 'Filter By' dropdown, 'Party' dropdown, 'Type' dropdown, 'Status' dropdown, 'Clear Filters', and 'Help'. The main table displays a list of addresses with columns: Party, Type, Flags, Status, Source, Confirmation Source, Address Line 1, Address Line 2, City/Town, County, Post Code, and Country.

Party	Type	Flags	Status	Source	Confirmation Source	Address Line 1	Address Line 2	City/Town	County	Post Code	Country
Vanner, Yseult	HOME	A C P	UNKNOWN	MIGRATION		79 Rusridge Rd.		Warwickshire		LH3 9IW	
Vanner, Yseult	HOME	C	UNKNOWN	MIGRATION		58 Quarterstaff St.	Pence Springs	Essex		FS8 3AS	
Vanner, Yseult	HOME	C	UNKNOWN	MIGRATION		439A Wailawa Esplanade	Sweetwater	Leicestershire		KM1R 2EE	

Navigation: Previous 1 Next

Party: Person associated to the address.

Type: Type of address, such as home or work.

Flags: Flags set for the address. Valid values are:

A = Active (address is in use)

Latitude Printable Help

C = Correspondence (users and the system can send correspondence to this address)

P = Primary (address is the primary address on the account)

Status: Status of the address, such as good, bad, or unknown.

Source: Source who provided the address, such as customer, client, or credit bureau.

Confirmation Source: Source who confirmed the validity of the address.

Address line 1: Person's address line 1.

Address line 2: Person's address line 2.

City/Town: Person's city or town.

County: Person's county.

Post Code: Person's postal code.

Country: Person's country.

- To display addresses that meet specific criteria only, do one or more of the following:
 - To limit the addresses to a specific person on the account, in the **Party** box, click the person's name.
 - To limit the addresses to a specific type, in the **Type** box, click the address type.
 - To limit the addresses to a specific status, in the **Status** box, click the status.

Only the addresses that match the selected criteria appear in the panel.

Tip: To clear the filters and display all addresses, click **Clear Filters**.

Add an Address

Use the **Add Address** dialog box to add an address to the account. You must have the Address Maintenance Permission.

To add an address

- In the **Reference Panel** navigation bar, click **Available Panels** and then click **Address**.

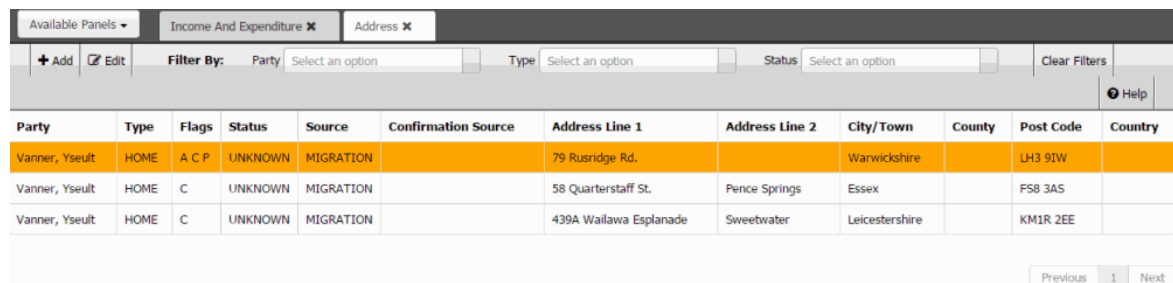

Party	Type	Flags	Status	Source	Confirmation Source	Address Line 1	Address Line 2	City/Town	County	Post Code	Country
Vanner, Yseult	HOME	A C P	UNKNOWN	MIGRATION		79 Rusridge Rd.		Warwickshire		LH3 9IW	
Vanner, Yseult	HOME	C	UNKNOWN	MIGRATION		58 Quarterstaff St.	Pence Springs	Essex		FS8 3AS	
Vanner, Yseult	HOME	C	UNKNOWN	MIGRATION		439A Wallawa Esplanade	Sweetwater	Leicestershire		KM1R 2EE	

- In the **Address** toolbar, click **Add**.

Add Address

Address Owner	<input type="text" value="Vanner, Yseult"/>	Address Line 1	<input type="text"/>
Type of Address	<input type="text"/>	Address Line 2	<input type="text"/>
Status of Address	<input type="text"/>	City / Town	<input type="text"/>
Source	<input type="text"/>	County	<input type="text"/>
Confirmation	<input type="text"/>	Post Code	<input type="text"/>
Active	<input type="checkbox"/>	Country	<input type="text"/>
Primary	<input type="checkbox"/>		
Correspondence	<input type="checkbox"/>		

Address Owner: Person associated to the address.

Type of Address: Type of address, such as home or work.

Status of Address: Status of the address, such as good, bad, or unknown.

Source: Source who provided the address, such as customer, client, or credit bureau.

Confirmation: Source who confirmed the validity of the address.

Active: If selected, the address is in use.

Primary: If selected, the address is the primary (main) address on the account.

Correspondence: If selected, you can send correspondence to this address.

Address line 1: Person's address line 1.

Address line 2: Person's address line 2.

City/Town: Person's city or town.

County: Person's county.

Post Code: Person's postal code.

Country: Person's country.

3. Complete the information and then click **Save**.

Modify an Address

Use the **Edit Address** dialog box to modify an address for the account. You must have the Address Maintenance Permission.

To modify an address

1. In the **Reference Panel** navigation bar, click **Available Panels** and then click **Address**.

Latitude Printable Help

Available Panels											
Income And Expenditure ✕											
Address ✕											
+ Add Edit Filter By: Party Select an option Type Select an option Status Select an option Clear Filters Help											
Party	Type	Flags	Status	Source	Confirmation Source	Address Line 1	Address Line 2	City/Town	County	Post Code	Country
Vanner, Yseult	HOME	A C P	UNKNOWN	MIGRATION		79 Rusridge Rd.		Warwickshire		LH3 9IW	
Vanner, Yseult	HOME	C	UNKNOWN	MIGRATION		58 Quarterstaff St.	Pence Springs	Essex		FS8 3AS	
Vanner, Yseult	HOME	C	UNKNOWN	MIGRATION		439A Willawa Esplanade	Sweetwater	Leicestershire		KM1R 2EE	

Previous 1 Next

- In the data grid, click the address and then, in the **Address** toolbar, click **Edit**.

Edit Address

Type of Address	Home	Address Line 1	79 Rusridge Rd.
Status of Address	Good	Address Line 2	
Source	Client	City/Town	Warwickshire
Confirmation	Client	County	
Active	<input checked="" type="checkbox"/>	Post Code	LH3 9IW
Primary	<input checked="" type="checkbox"/>	Country	
Correspondence	<input checked="" type="checkbox"/>		

Save Help Cancel

Type of Address: Type of address, such as home or work.

Status of Address: Status of the address, such as good, bad, or unknown.

Source: Source who provided the address, such as customer, client, or credit bureau.

Confirmation: Source who confirmed the validity of the address.

Active: If selected, the address is in use.

Primary: If selected, the address is the primary (main) address on the account.

Correspondence: If selected, you can send correspondence to this address.

Address line 1: Person's address line 1.

Address line 2: Person's address line 2.

City/Town: Person's city or town.

County: Person's county.

Post Code: Person's postal code.

Country: Person's country.

- Modify the information and then click **Save**.

Note: If the person whose address you modified has other accounts, Latitude updates the address on those accounts also.

AIM

AIM

Use the **AIM** panel to view information from the Agency Interface Module (AIM) program. AIM allows you to track and maintain information for the accounts that clients placed with outside collection agencies or attorneys.

View General AIM Information

Use the **General** tab in the **AIM** panel to view general information pulled from the AIM program for the account.

To view general AIM information

1. In the **Reference Panel** navigation bar, click **Available Panels** and then click **AIM**.
2. In the **AIM** panel, click the **General** tab.

The screenshot shows the AIM panel interface. At the top, there is a navigation bar with 'Available Panels' and 'AIM Panel'. Below this is a tabbed interface with 'General', 'History', 'Requests/Notifications', 'Arrangements', and 'Work Efforts'. The 'General' tab is active, displaying a table with the following data:

Agency/Attorney Name	Not Currently Placed
Agency/Attorney AlphaCode	Not Currently Placed
Agency/Attorney ID	Not Currently Placed
Agency/Attorney Tier	Not Currently Placed
Has Acknowledged Placement	Not Currently Placed
Current Fee Status	Not Currently Placed
Current Final Recall Objection Status	Not Currently Placed
Last Placed On	Not Currently Placed
Last Recalled On	Never Recalled
Next Automatic Pending Recall On	Not Currently Placed
Next Automatic Final Recall On	Not Currently Placed
Placed Balance	\$0.00
Current Balance	\$917.54

Agency/Attorney Name: Name of the outside collection agency or attorney where the client placed the account.

Agency/Attorney AlphaCode: External code that identifies the outside collection agency or attorney where the client placed the account. The system uses this code when creating files and folders for the agency or attorney.

Agency/Attorney ID: Code that the system assigns to identify the outside collection agency or attorney where the client placed the account.

Agency/Attorney Tier: Number used to group the outside collection agency or attorney where the client placed the account based on performance or preference.

Has Acknowledged Placement: Indicates whether the outside collection agency or attorney confirmed receipt of the account.

Current Fee Status: Fee schedule or commission percentage for applying commissions.

Current Final Recall Objection Status: Indicates whether the system received a final recall objection from the outside collection agency or attorney.

Last Placed On: Date the client last placed the account with an outside collection agency or attorney.

Last Recalled On: Date the system last recalled the account from the outside collection agency or attorney.

Next Automatic Pending Recall On: Date of the next automatic pending recall.

Next Automatic Final Recall On: Date of the next automatic final recall.

Placed Balance: Balance on the account when the client placed the account with the outside collection agency or attorney.

Current Balance: Current account balance.

View AIM History

Use the **History** tab in the **AIM** panel to view transaction history pulled from the AIM program for the account.

To view AIM history

1. In the **Reference Panel** navigation bar, click **Available Panels** and then click **AIM**.
2. In the **AIM** panel, click the **History** tab.

Transaction Type	Agency/Attorney	Date	Message	Balance	
Export Demographic Address Update	Collectors Plus Services	1/27/2014	Processed, no errors.	\$191.00	
Export Demographic Phone Update	Collectors Plus Services	1/27/2014	Processed, no errors.	\$191.00	
Import Notes	Collectors Plus Services	1/27/2014	Processed, no errors.	\$1,040.96	Details
Import Requests and Responses	Collectors Plus Services	1/27/2014	Processed, no errors.	\$1,234.68	Details
Export Assets	Collectors Plus Services	1/27/2014	Processed, no errors.	\$1,234.68	

Previous 1 2 3 4 5 6 Next

Transaction Type: Type of AIM transaction.

Agency/Attorney: Outside collection agency or attorney that held the account when AIM processed the transaction.

Date: Date that AIM processed the transaction.

Message: Information regarding the transaction.

Balance: Balance on the account when AIM processed the transaction.

View AIM History Details

Use the **AIM History Details** dialog box to view transaction history details pulled from the AIM program for the account.

To view AIM history details

1. In the **Reference Panel** navigation bar, click **Available Panels** and then click **AIM**.
2. In the **AIM** panel, click the **History** tab.
3. In the data grid, click **Details**.

AIM History Details

Import Notes	
Field	Value
FILE NUMBER	1120
CREATED DATETIME	2010-10-08T00:00:00-04:00
NOTE ACTION	CC
NOTE RESULT	CC
NOTE COMMENT	WP-4157593300
IS PRIVATE	F

Field: Transaction detail data item.

Value: Value associated to the transaction detail data item.

View AIM Requests and Notifications

Use the **Requests/Notifications** tab in the **AIM** panel to view requests and notifications pulled from the AIM program for the account.

To view AIM requests and notifications

1. In the **Reference Panel** navigation bar, click **Available Panels** and then click **AIM**.
2. In the **AIM** panel, click the **Requests/Notifications** tab.

Origination	Entity	Request	Requested	Response	Responded	Status	Request ID	
External	Collections Plus Services	DSP	12/13/2012	NDSP	1/2/1900	Responded on time	4	Responded
External	Collections Plus Services	EXT	1/7/2013			Response is 7 days over	337	Set Response
External	Collections Plus Services	DOCS	12/13/2012	NOMED	1/2/1900	Responded on time	670	Responded
External	Collections Plus Services	DSP	3/23/2013	NDSP	1/2/1900	Responded on time	1003	Responded
External	Collections Plus Services	EXT	4/17/2013			Response is 29 days over	1336	Set Response

Previous 1 2 3 Next

Origination: Source where the request or notification originated.

Entity: Organization or individual that sent the request or notification.

Request: Code that identifies the type of request or notification.

Requested: Date of the request or notification.

Response: Code that identifies the response to the request or notification.

Responded: Date of the response to the request or notification.

Status: Status of the response to the request or notification.

Request ID: Code that identifies the request.

Create an AIM Request

Use the **New Request** dialog box to create a request for the outside collection agency or attorney that holds the account. If an outside collection agency or attorney doesn't hold the account, you cannot create a request.

To create an AIM request

1. In the **Reference Panel** navigation bar, click **Available Panels** and then click **AIM**.
2. In the **AIM** toolbar, click **Create Request**.

New Request

Request Code/Description: Dispute Request from Agency

Requested Date:

Request Text:

Save Cancel Help

Request Code/Description: Code and description that identify the type of request.

Requested Date: Date of the request.

Request Text: More information regarding the request.

3. Complete the information and click **Save**. The system adds the request to the data grid on the **Requests/Notifications** tab.

Create an AIM Response

Use the **New Response** dialog box to create a response to a request for the outside collection agency that holds the account.

To create an AIM response

1. In the **Reference Panel** navigation bar, click **Available Panels** and then click **AIM**.
2. In the **AIM** panel, click the **Requests/Notifications** tab.
3. In the data grid, click **Set Response**.

New Response

Code/Description: APDSP ▾ Dispute Approved

Responded Date: 01/27/2014 

Response Text: The dispute has been approved; please close and return

Save **Cancel**  **Help**

Code/Description: Code and description that identify the type of response.

Responded Date: Date of the response.

Response Text: More information regarding the response.

4. Complete the information and click **Save**. The system adds the response to the data grid on the **Requests/Notifications** tab, and sets the status to "responded."

View AIM Arrangements

Use the **Arrangements** tab in the **AIM** panel to view payment arrangement information pulled from the AIM program for the account.

To view AIM arrangements

1. In the **Reference Panel** navigation bar, click **Available Panels** and then click **AIM**. The **AIM** panel appears.
2. In the **AIM** panel, click the **Arrangements** tab. The **Arrangements** tab appears.

Agency/Attorney Name	Date Created	Due Date	Amount
Collections Plus Services	7/19/2013	7/21/2013	\$10.00
Collections Plus Services	7/19/2013	8/4/2013	\$10.00
Collections Plus Services	7/19/2013	8/18/2013	\$10.00
Collections Plus Services	7/19/2013	9/1/2013	\$10.00
Collections Plus Services	7/19/2013	9/15/2013	\$10.00
Collections Plus Services	7/19/2013	9/29/2013	\$10.00
Collections Plus Services	7/19/2013	10/13/2013	\$10.00
Collections Plus Services	7/19/2013	10/27/2013	\$10.00
Collections Plus Services	7/19/2013	11/10/2013	\$10.00
Collections Plus Services	7/19/2013	11/24/2013	\$10.00

Agency/Attorney Name: Outside collection agency or attorney that holds the account.

Date Created: Date a user created the payment arrangement.

Due Date: Date the payment is due.

Amount: Payment amount due.

View AIM Work Efforts

Use the **Work Efforts** tab in the **AIM** panel to view work effort information pulled from the AIM program for the account.

To view AIM work efforts

1. In the **Reference Panel** navigation bar, click **Available Panels** and then click **AIM**. The **AIM** panel appears.
2. In the **AIM** panel, click the **Work Efforts** tab. The **Work Efforts** tab appears.

Agency Name	Action Date	Category	Code	Description
Collection Plus Services	5/25/2014	Letter	0152	

Agency Name: Outside collection agency or attorney that holds the account.

Action Date: Date the work effort occurred.

Category: Type of work effort.

Code: Code that identifies the work effort.

Description: Description of the work effort.

View Arrangement History

Use the **Arrangement History** panel to view historical payment arrangement information for the account.

To view arrangement history

- In the **Reference Panel** navigation bar, click **Available Panels** and then click **Arrangement History**.

Available Panels ▾ Arrangement History ✖													Help	
No.	Effective Start Date	First Pay Date	Type	User	Install	Frequency	Paycount	Discount	Method	Paid	Status	Canceled Date	Failed Date	
21449	09/11/2015	09/11/2015	PIF	gs	£205.28	monthly, 9	1	0%	CC	£0.00	Active			

Previous 1 Next

No.: Unique number that the system assigns to identify an arrangement.

Effective Start Date: Date the arrangement starts.

First Pay Date: Date the first payment is due.

Type: Type of arrangement, such as SIF or PIF.

User: User who created the arrangement.

Install: Amount of each payment.

Frequency: How often each payment is due.

Paycount: Number of payments in the arrangement.

Discount: Percent discount offered.

Method: Method to use to process the payment, such as credit card or check.

Paid: Amount paid toward the arrangement to date.

Status: Status of the payment.

Canceled Date: Date the user canceled the arrangement.

Failed Date: Payment decline date.

Automotive

Automotive

Use the **Automotive** panel to maintain vehicle collateral, repossession, lease, and auction information for the account displayed in the **Work Form**.

Maintain Automotive Collateral Information

Use the **Collateral** tab in the **Automotive** panel to maintain automotive collateral information for the account displayed in the **Work Form**.

To maintain automotive collateral information

1. In the **Reference Panel** navigation bar, click **Available Panels** and then click **Automotive**.
2. In the **Automotive** panel, click the **Collateral** tab.

The screenshot shows a web application interface for vehicle collateral management. At the top, there is a navigation bar with 'Available Panels' and 'Collateral x'. Below this is a secondary navigation bar with tabs for '47 New autos', '48 Used autos', '46 Recreational vehicle', 'New Sample', and 'Real_Desc'. The main content area is titled 'Collateral' and contains several sections of input fields:

- Collateral Section:** Includes fields for Year, Make, Model, Add-On, VIN, Manufacturing Code, Series Identifier, and radio buttons for Hours and Miles. It also has a Color field.
- Legal Code Section:** Includes Volume Date, Termination Date, Termination Effective Date, Finance Charge Due, Late Charge Due, Ignition Key Number, and Other Key Number.
- Key Type Section:** Includes Key Type, Odometer Type, Status, Damaged, Totaled, Collateral Drivable, Sell Collateral, and Description.
- Title Section:** Includes Title Position, Title State, Title Status, Lien on File, Title Requested Date, Title Received Date, Have Title, Repo Title Ordered Date, Repo Title Received Date, Repo Title Sent to Auction Date, and Comment.
- Tag Section:** Includes Tag, Decal State, Decal Number, and Decal Year.
- Replevin Section:** Includes Replevin, Replevin Status, Replevin Order Date, and Replevin Filed Date.
- Value Section:** Includes Fair Market Value, Purchase Amount, MSRP, NADA, and Balance at Repossession.
- Dealer Section:** Includes Dealer Code, Dealer Endorsement Code, and Decal Year.

A 'Save' button is located at the bottom left of the form area.

Collateral

Year: Vehicle model year.

Make: Vehicle manufacturer.

Model: Vehicle model.

Add-On: Optional features on the vehicle.

VIN: Vehicle Identification Number.

Manufacturing Code: Code that identifies the vehicle manufacturer.

Series Identifier: Series code that identifies the vehicle.

Color: Color of the vehicle.

Ignition Key Number: Number that identifies the ignition key.

Other Key Number: Number that identifies an extra vehicle key, such as the valet key.

Purchase Amount: Purchase amount the vehicle.

MSRP: Manufacturer Suggested Retail Price.

Fair Market Value: Amount the vehicle would sell for on the open market.

Hours: If selected, the number of hours on the vehicle.

Miles: If selected, the number of miles on the vehicle.

Totaled: If selected, the lien holder considers the vehicle totaled.

Damaged: If selected, the lien holder considers the vehicle damaged.

Sell Collateral: If selected, the lien holder intends to sell the vehicle for collateral.

Description: Description of the condition of the vehicle.

Legal Code: Legal code that grants the lien holder or credit agency the right to repossess the vehicle when the borrower defaults on the loan or lease agreement.

Volume Date:

Termination Date: Termination date of the loan contract.

Termination Effective Date: Date the termination of the loan contract became effective.

Finance Charge Due: Finance charge due on the loan.

Late Charge Due: Late charge due on the loan.

Tag

Decal State: State listed on the vehicle's license plate.

Decal Number: Vehicle's license plate number.

Decal Year: Vehicle's license plate year.

Title

Title Position: Position of the title (for example, original, duplicate).

Title State: State listed on the vehicle's title.

Title Status: Status of the vehicle's title (for example, salvage, rebuilt, junk).

Have Title: If selected, indicates that your organization has the title.

Dealer

Dealer Code: Dealer's license number.

Dealer Endorsement Code: Code that identifies the dealer's auto-broker endorsement.

Dealer Reserve Charge Back: Amount the finance company charged back to the dealer for early payoff of a loan.

3. Complete the information and then click **Save**.

Maintain Automotive Repossession Information

Use the **Repossession** tab in the **Automotive** panel to maintain automotive repossession information for the account displayed in the **Work Form**.

To maintain automotive repossession information

1. In the **Reference Panel** navigation bar, click **Available Panels** and then click **Automotive**.
2. In the **Automotive** panel, click the **Repossession** tab.

Status: Status of the vehicle repossession.

Repossession

Address: Location of the vehicle.

Policy Entity: Insurance agency where the repossession company has an insurance policy.

Date Repo Completed: Date the agency repossessed the vehicle.

Balance at Repossession: Balance due on the loan or lease when the vehicle was repossessed.

Repossession Expenses: Cost of repossessing the vehicle.

Collateral Status

Condition: Condition of the vehicle when the agency repossessed it.

Lease End/Repo: Indicates whether the lease ended or the agency repossessed the vehicle.

Repossession Code: Vehicle factory key code that allows the repossession agency to drive the vehicle away rather than tow it.

Collateral Drivable: If selected, the vehicle was drivable when the agency repossessed it.

Agency Information

Agency Name: Name of the repossession agency.

Agency Phone: Repossession agency's phone number.

Assigned: Repossession agency assignment date.

Redemption

Redemption Date: Last date the customer has to redeem the vehicle.

Redemption Amount: Amount the customer must remit to redeem the vehicle. This amount can include past due amounts, total remainder of the debt, and any fees incurred from the repossession.

Date Released: Vehicle release date to customer.

Redeemed by: Person who redeemed the vehicle.

Released: Method of release.

Storage

Date Into Storage: Repossessed vehicle's storage date.

Storage Location: Storage location of the repossessed vehicle.

Storage Comments: Comments regarding storage of the repossessed vehicle.

Redemption

Repossession Fees: Repossession fees incurred.

Storage Fees: Storage fees incurred.

Key Cut Fee: Fee for having a key made.

Misc Fees: Miscellaneous fees related to the repossession.

Impound Fee: Impound fee incurred.

3. Complete the information and then click **Save**.

Automotive Auction

Automotive Auction

Use the **Auction** panel to maintain automotive repairs, bids, appraisals, and auction information for the account displayed in the **Work Form**.

Maintain Automotive Auction Information

Use the **Main** tab on the **Auction** tab in the **Automotive** panel to maintain automotive auction information for the account displayed in the **Work Form**.

To maintain automotive auction information

1. With an account displayed in the **Work Form**, in the **Reference Panel** navigation bar, click **Available Panels** and then click **Automotive**.
2. In the **Automotive** panel, click the **Auction** tab and then click the **Main** tab.

Repairs

Collateral Repairs Needed: If selected, the vehicle needs repairs.

Sell as is: Indicates whether the vehicle is selling in "as is" or "repaired" condition.

Description: Description of the needed repairs.

Approved: Repair approval date.

Ordered: Repair order date.

Completed: Repair completion date.

Comments: Comments regarding the repairs.

Repaired Value: Monetary value of the vehicle after repairs.

Auction Information

Inspection Date: Date the auction house inspected the vehicle.

Location: Location of the auction house.

Collateral Appraiser Code: Code that identifies the appraiser.

Appraisal Verified: Appraisal verification date.

Buyer PO Number: Vehicle buyer's purchase order number.

Bid Closed: Date bidding on the vehicle closed.

Collateral Avail for Resale: Date the vehicle became available for resale.

Collateral Sold: Date the vehicle sold at auction.

Payment Received: Date your organization received the payment from the auction house.

Collateral Sale Price: Amount the vehicle sold for.

Auction Expense: Fees associated with auctioning the vehicle.

Collateral Stock Number: Stock number the auction house assigned to the vehicle.

Letters

Letter to Lien Holder 1: Date your organization sent a letter to the first lien holder regarding auctioning of the vehicle.

Letter to Lien Holder 2: Date your organization sent a letter to the second lien holder regarding auctioning of the vehicle.

Notice to Guarantor: Date your organization sent a notice to the guarantor regarding auctioning of the vehicle.

Notice to Maker: Date your organization sent a notice to the lender regarding auctioning of the vehicle.

Notice to Other: Date your organization sent a notice to another party regarding auctioning of the vehicle.

Title

Title Ordered Date: Date your organization ordered the vehicle title.

Title Sent to Auction: Date your organization sent the vehicle title to the auction house.

Title Received Date: Date the auction house received the vehicle title.

3. Complete the information and then click **Save**.

View Automotive Repair Bids

Use the **Repair Bids** tab on the **Auction** tab in the **Automotive** panel to view automotive repair bids for the account displayed in the **Work Form**.

To view automotive repair bids

1. With an account displayed in the **Work Form**, in the **Reference Panel** navigation bar, click **Available Panels** and then click **Automotive**.
2. In the **Automotive** panel, click the **Auction** tab.
3. On the **Auction** tab, click the **Repair Bids** tab.

Accept Estimate	Repair Code	Repair Estimate
true	test	1003
true	OLD	345
true	opl	123

Accept Estimate: Indicates whether your organization accepted the repair estimate.

Repair Code: Code that identifies the type of repair.

Repair Estimate: Estimated cost of repair.

View Automotive Appraisals

Use the **Appraisals** tab on the **Auction** tab in the **Automotive** panel to view automotive appraisals for the account displayed in the **Work Form**.

To view automotive appraisals

1. With an account displayed in the **Work Form**, in the **Reference Panel** navigation bar, click **Available Panels** and then click **Automotive**.
2. In the **Automotive** panel, click the **Auction** tab.
3. On the **Auction** tab, click the **Appraisals** tab.

Appraiser Code	Average Value	Retail Value	Source Publication	Appraisal Received
test	10	11	BLACK BOOK	11/12/19 5:00 am
TREW	123	230	BLUE BOOK	11/11/19 7:30 am

Appraiser Code: Code that identifies the appraiser.

Average Value: Average value of the vehicle.

Retail Value: Retail value of the vehicle.

Source Publication: Source from which your organization obtained the appraisal (for example, Kelley Blue Book).

Appraisal Received: Date your organization received the appraisal.

View Automotive Purchasing Bids

Use the **Bids** tab on the **Auction** tab in the **Automotive** panel to view automotive purchasing bids for the account that is displayed in the **Work Form**.

To view automotive purchasing bids

1. With an account displayed in the **Work Form**, in the **Reference Panel** navigation bar, click **Available Panels** and then click **Automotive**.
2. In the **Automotive** panel, click the **Auction** tab.
3. On the **Auction** tab, click the **Bids** tab.

Bid Date	Bid Received Amount	Counter Date	Counter Amount	Accepted Date	Accept Bid	Bidder Code
11/22/19 12:00 am	10	11/15/19 5:00 am	10	11/13/19 5:00 am	false	test
11/15/19 12:00 am	100	11/12/19 5:00 am	1001	11/11/19 5:00 am	true	10

Accept Bid: Indicates whether your organization accepted the bid.

Bidder Code: Code that identifies the bidder.

Bid Amount: Amount of the bid.

Bid Date: Date the buyer placed the bid.

Maintain Automotive Lease Information

Use the **Lease** tab in the **Automotive** panel to maintain automotive lease information for the account displayed in the **Work Form**.

To maintain automotive lease information

1. In the **Reference Panel** navigation bar, click **Available Panels** and then click **Automotive**.
2. In the **Automotive** panel, click the **Lease** tab.

Term (Months): Length of the lease, in months.

Effective Date: Date the lease became effective.

Maturity Date: Date the lease matured.

Return Date: Date the leasing agency received the vehicle.

Disposition Date: Date the leasing agency determined the status of the returned vehicle.

Inspection Received Date: Date the leasing agency inspected the vehicle.

Original Miles: Original mileage on the leased vehicle.

Inception Miles: Mileage at the beginning of the lease term.

Contract Miles: Mileage allowed under the leasing contract.

Purchase Miles: Number of extra miles purchased.

End of Term Miles: Mileage at the end of the lease term.

Excess Miles: Number of miles in excess of the contract and purchased miles.

Unused Miles: Number of unused contract and purchased miles.

Contract Obligation: Total amount due under the lease agreement. This amount excludes the security deposit, sales tax, and any other fees and taxes paid to a third party.

Security Deposit: Amount the lessee paid as a security deposit.

Residual: Lease-end value of the vehicle.

Residual Gain/Loss: Difference between the residual value and the end-of-lease purchase price.

Disposal Assessed Amount: Amount charged to dispose of the vehicle.

Unpaid Month Payment: Number of months during the lease term that the lessee did not make a payment.

Unpaid Tax: Amount in unpaid taxes that the lessee owes.

Wear and Tear: Total amount charged for wear and tear on the vehicle.

Minor Wear Charge: Amount charged for minor wear on the vehicle.

Major Wear Charge: Amount charged for major wear on the vehicle.

End of Term Tax Assessed: Tax assessed at the end of the lease.

Excess Mileage: Amount charged for each mile in excess of the mileage limit.

Mileage Credit: Amount credited for unused mileage.

Other Tax Assessed: Amount charged for other taxes (for example, property tax).

3. Complete the information and then click **Save**.

Collateral

Collateral

Use the **Collateral** panel to maintain vehicle and real estate collateral information. You can modify collateral items but you cannot add them. Latitude adds pieces of collateral to the panel based on the data bridge file that the client provides for the account. Latitude creates one tab for each piece of collateral in the bridge file. You must have the Allow Collateral Editing Permission.

Important!

If you are using the Recovery Database Network (RDN) system to exchange collateral data, DO NOT modify the collateral data manually that the RDN system populates. The ability to edit collateral is for clients who aren't using the RDN system. Genesys cannot determine which clients use the RDN system so it's up to the clients who use the RDN system to ensure that they don't modify the data.

Maintain Vehicle Collateral Information

Use the **Collateral** tab in the **Collateral** panel to maintain collateral information for a vehicle.

To maintain vehicle collateral information

1. In the **Reference Panel** navigation bar, click **Available Panels** and then click **Collateral**.
2. Click the tab for the collateral to modify and then click the **Collateral** tab.

Ignition Key Number: Number that identifies the ignition key.

Other Key Number: Number that identifies an extra vehicle key, such as the valet key.

Key Type: Type of ignition key, such as single or double cut.

Odometer Type: Type of odometer, such as digital or analog.

Status

Damaged: If selected, the lienholder considers the vehicle damaged.

Totaled: If selected, the lienholder considers the vehicle totaled.

Collateral Drivable: If selected, indicates that the vehicle is drivable.

Sell Collateral: If selected, the lienholder intends to sell the vehicle for collateral.

Description: Description of the condition of the vehicle.

Title

Title Position: Type of title (for example, original, duplicate).

Title State: State listed on the vehicle's title.

Title Status: Status of the vehicle's title (for example, salvage, rebuilt, junk).

Lien on File: Indicates whether a lien is on file with the state.

Title Requested Date: Indicates the date the lienholder requested the vehicle's title from the state.

Title Received Date: Indicates the date the lienholder received the vehicle's title from the state.

Have Title: If selected, indicates that your organization has the vehicle's title.

Repo Title Ordered Date: Date the lienholder ordered a repossession title for the vehicle.

Repo Title Received Date: Date the lienholder received the repossession title for the vehicle.

Repo Title Send to Auction Date: Date the lienholder sent the vehicle's repossession title to the auction house.

Comment: Other information regarding the vehicle's title.

Tag

Decal State: State listed on the vehicle's license plate.

Decal Number: Vehicle's license plate number.

Decal Year: Vehicle's license plate year.

Replevin

Replevin Status: Status of the recovery.

Replevin Order Date: Date the lienholder ordered the recovery.

Replevin Filed Date: Date the lienholder scheduled the recovery.

Value

Fair Market Value: Amount the vehicle would sell for on the open market.

Purchase Amount: Purchase amount of the vehicle.

MSRP: Manufacturer Suggested Retail Price.

NADA: The vehicle's National Association of Automobile Dealers blue book value.

Balance at Repossession: Balance due on the vehicle or lease at time of repossession.

GL Entry Date: Date the lienholder posted the surplus or deficiency amount in the General Ledger.

Dealer

Dealer Code: Dealer's license number.

Dealer Endorsement Code: Code that identifies the dealer's auto-broker endorsement.

Dealer Reserve Charge Back: Amount the finance company charged back to the dealer for early payoff of a loan.

3. Complete the information and then click **Save**.

Note: When you update collateral data on the **Collateral** panel, Latitude doesn't update the RDN system automatically. You must send an update. For more information, see [Send a Case Update to RDN](#).

Maintain Repossession Information

Use the **Repossession** tab in the **Collateral** panel to maintain repossession information for a vehicle. If your organization uses RDN, Latitude populates the data on this tab from the RDN APIs based on the repossession activity of the repossession agent or agency.

To maintain repossession information

1. In the **Reference Panel** navigation bar, click **Available Panels** and then click **Collateral**.
2. Click the tab for the collateral to modify and then click the **Repossession** tab.

The screenshot shows a web-based form for vehicle repossession. At the top, there are navigation tabs for '47 New autos', '48 Used autos', '46 Recreational vehicle', 'New Sample', and 'Real_Desc'. Below these are sub-tabs for 'Collateral', 'Repossession', 'Auction', and 'Lease'. The 'Repossession' tab is active. The form is organized into columns:

- Repossession:** Status (dropdown), Repo Address (text), Policy Entity (dropdown), Repossession Date (calendar), Repossession Expenses (\$) (text), Repo Action (dropdown), Order Type (dropdown), Collateral Status (text), Condition (dropdown), Lease End Repo (dropdown), Repossession Code (text), Collateral Drivable (checkbox).
- Agent Information:** Agent Name (text), Agent Phone (text), Assigned (calendar), Redemption (text), Redemption Date (calendar), Redemption Amount (\$) (text), Date Released (calendar), Redesmed By (text), Released (dropdown), Redemption Expire Date (calendar).
- Redemption Fees:** Storage Fees (\$), Key Cut Fees (\$), Misc Fees (\$), Impound Fees (\$), Repossession Fees (\$), Fuel Sub Fees (\$), Sale Fees (\$), Repair Fees (\$), Title Fees (\$), Cost of Repo (\$), Storage Date Info Storage (calendar), Storage Location (text), City (text), State (dropdown), Zip (text), Storage Comments (text).
- Transport:** Transport Order Date (calendar), Transport Arrival Date (calendar), Transport Date (calendar), Transport Released To (text), Transport Notes (text area).

A 'Save' button is located at the bottom left of the form area.

Repossession

Status: Status of the vehicle repossession.

Repo Address: Location of the vehicle.

Policy Entity: Insurance agency where the repossession company has an insurance policy.

Repossession Date: Date the agent repossessed the vehicle.

Repossession Expenses: Total cost to repossess the vehicle.

Repo Action: Action that prompted the repossession.

Order Type: Repossession order type.

Collateral Status

Condition: Condition of the vehicle when the agent repossessed it.

Lease End Repo: Indicates whether the lease ended or the agent repossessed the vehicle.

Repossession Code: Vehicle factory key code that allows the repossession agent to drive the vehicle away rather than tow it.

Collateral Drivable: If selected, the vehicle was drivable when the agent repossessed it.

Agent Information

Agent Name: Name of the repossession agent.

Agent Phone: Repossession agent's phone number.

Assigned: Date your organization assigned the agent to repossess the vehicle.

Redemption

Redemption Date: Last date the customer has to redeem the vehicle.

Redemption Amount: Amount the customer must remit to redeem the vehicle. This amount can include past due amounts, total remainder of the debt, and any fees incurred from the repossession.

Date Released: Date your organization released the vehicle to the customer.

Redeemed by: Person who redeemed the vehicle.

Released: Method of release.

Redemption Expire Date: Date the redemption expires.

Redemption Fees

Storage Fees: Fees to store the vehicle.

Key Cut Fee: Fees to have a key cut.

Misc Fees: Miscellaneous fees related to the repossession.

Impound Fees: Fees to impound the vehicle.

Repossession Fees: Fees to repossess the vehicle

Fuel Sub Fees: Fees to fuel the vehicle.

Sale Fees: Fees to sell the vehicle.

Repair Fees: Fees to repair the vehicle.

Title Fees: Fees to title the vehicle.

Cost of Repo: Repossession costs

Storage

Date Into Storage: Date the agent placed the vehicle into storage.

Storage Location: Address where the repossessed vehicle is in storage.

Storage Comments: Comments regarding storage of the repossessed vehicle.

Transport

Transport Order Date: Date your organization requested transport of the vehicle.

Transport Arrival Date: Date the vehicle arrived at its destination.

Transport Date: Date the agent transported the vehicle.

Transport Released To: Person to whom the agent released the vehicle upon transport.

Transport Notes: Comments regarding transport of the vehicle.

3. Complete the information and then click **Save**.

Auction

Maintain Auction Information

Use the **Main** tab on the **Auction** tab in the **Collateral** panel to maintain auction information for a vehicle.

To maintain auction information

1. In the **Reference Panel** navigation bar, click **Available Panels** and then click **Collateral**.
2. Click the tab for the collateral to modify and then click the **Auction** tab and then click the **Main** tab.

The screenshot shows the 'Collateral' panel with the following sections:

- Repairs:** Includes checkboxes for 'Collateral Repairs Needed', 'Sell As Is', and 'Repaired'. It has a 'Description' text area, 'Approved', 'Ordered', and 'Completed' date pickers, a 'Comments' text area, and a 'Repaired Value' monetary field.
- Auction Information:** Includes 'Inspection Date', 'Location', 'Collateral Appraiser Code', 'Appraisal Verified', 'Buyer PO Number', 'Bid Closed', 'Collateral Avail For Resale', 'Collateral Sold', 'Payment Received', 'Collateral Sale Price', 'Auction Expense', 'Collateral Stock Number', and 'Date Appraisal Received'.
- Letters:** Includes 'Notice Plan to Sell to Borrower', 'Notice Plan to Sell to Co-Borrower', 'Cancellation Letter Sent', 'Notice to Maker', and 'Notice to Other'.
- Title:** Includes 'Title Ordered Date', 'Title Sent to Auction', and 'Title Received Date'.
- Auction:** Includes 'Repo Sale Date', 'Floor Appraisal Amount', 'Repo Auction Phone #', 'Repo Auction Contact', 'Repo Auction Address', 'City', 'State' (dropdown menu), 'Zip', 'Chargeable Damage', 'Check #', and 'Check Amount'.

Repairs

Collateral Repairs Needed: If selected, the vehicle needs repairs.

Sell as is: Indicates whether the vehicle is selling "as is" or in "repaired" condition.

Description: Description of the needed repairs.

Approved: Repair approval date.

Ordered: Repair order date.

Completed: Repair completion date.

Comments: Comments regarding the repairs.

Repaired Value: Monetary value of the vehicle after repairs.

Auction Information

Inspection Date: Date the auction house inspected the vehicle.

Location: Location of the auction house.

Collateral Appraiser Code: Code that identifies the appraiser.

Appraisal Verified: Appraisal verification date.

Buyer PO Number: Vehicle buyer's purchase order number.

Bid Closed: Date bidding on the vehicle closed.

Collateral Avail for Resale: Date the vehicle became available for resale.

Collateral Sold: Date the vehicle sold at auction.

Payment Received: Date your organization received the payment from the auction house.

Collateral Sale Price: Amount the vehicle sold for.

Auction Expense: Fees associated with auctioning the vehicle.

Collateral Stock Number: Stock number the auction house assigned to the vehicle.

Date Appraisal Received: Date your organization received the vehicle appraisal.

Letters

Notice Plan to Sell to Borrower: Date your organization sent a letter to the borrower regarding the intent to sell the vehicle.

Notice Plan to Sell to Co-Borrower: Date your organization sent a letter to the co-borrower regarding the intent to sell the vehicle.

Cancellation Letter Sent: Date your organization sent a letter to the borrower regarding cancellation of the intent to sell the vehicle.

Notice to Maker: Date your organization sent a notice to the lender regarding the intent to sell the vehicle.

Notice to Other: Date your organization sent a notice to another party regarding the intent to sell the vehicle.

Title

Title Ordered Date: Date your organization ordered the vehicle's title.

Title Sent to Auction: Date your organization sent the vehicle's title to the auction house.

Title Received Date: Date the auction house received the vehicle's title.

Auction

Chargeable Damage: Amount charged to the auction house for damage to the vehicle while in their care.

Check #: Number of the check received from the auction house.

Check Amount: Amount of the check received from the auction house.

Repo Sale Date: Date the vehicle is scheduled to sell at auction.

Floor Appraisal Amount: Appraisal amount that the auction house determined for the vehicle.

Repo Auction Phone Number: Auction house phone number.

Repo Auction Contact: Name of the contact person at the auction house.

Repo Auction Address: Address where the auction house is located.

3. Complete the information and then click **Save**.

Repair Bids

View Repair Bids

Use the **Repair Bids** tab on the **Auction** tab in the **Collateral** panel to view bids to repair a vehicle.

To view repair bids

1. In the **Reference Panel** navigation bar, click **Available Panels** and then click **Collateral**.
2. Click the tab for the collateral to modify, click the **Auction** tab, and then click the **Repair Bids** tab.

Accept Estimate	Repair Code	Repair Estimate
true	test	1003
true	OLD	345
true	opl	123

Accept Estimate: Indicates whether your organization accepted the repair estimate.

Repair Code: Code that identifies the type of repair.

Repair Estimate: Estimated cost of repair.

Add a Repair Bid

Use the **Add a Repair Bid** dialog box to add a bid to repair a vehicle.

To add a repair bid

1. In the **Reference Panel** navigation bar, click **Available Panels** and then click **Collateral**.
2. Click the tab for the collateral to modify, click the **Auction** tab, and then click the **Repair Bids** tab.

Accept Estimate	Repair Code	Repair Estimate
true	test	1003
true	OLD	345
true	opl	123

3. In the **Repair Bids** toolbar, click **Add Repair Bid**.

Add Repair Bid

Accept Estimate	<input type="checkbox"/>
Repair Code	<input type="text"/>
Repair Estimate	\$ <input type="text"/>

Accept Estimate: If selected, your organization accepted the repair estimate.

Repair Code: Code that identifies the type of repair.

Repair Estimate: Estimated cost of repair.

- Complete the information and then click **Save**.

Modify a Repair Bid

Use the **Edit Repair Bid** dialog box to modify a bid to repair a vehicle.

To modify a repair bid

- In the **Reference Panel** navigation bar, click **Available Panels** and then click **Collateral**.
- Click the tab for the collateral to modify, click the **Auction** tab, and then click the **Repair Bids** tab.

Accept Estimate	Repair Code	Repair Estimate
true	test	1003
true	OLD	345
true	opl	123

- In the **Repair Bids** toolbar, click **Edit Repair Bid**.

Edit Repair Bid

Accept Estimate	<input checked="" type="checkbox"/>
Repair Code	<input type="text" value="EXH"/>
Repair Estimate	\$ <input type="text" value="552"/>

Accept Estimate: If selected, your organization accepted the repair estimate.

Repair Code: Code that identifies the type of repair.

Repair Estimate: Estimated cost of repair.

- Modify the information and then click **Save**.

Appraisals

View Appraisals

Use the **Appraisals** tab on the **Auction** tab in the **Collateral** panel to view appraisals for a vehicle.

To view appraisals

1. In the **Reference Panel** navigation bar, click **Available Panels** and then click **Collateral**.
2. Click the tab for the collateral to modify, click the **Auction** tab, and then click the **Appraisals** tab.

Appraiser Code	Average Value	Retail Value	Source Publication	Appraisal Received
test	10	11	BLACK BOOK	11/12/19 5:00 am
TREV	123	230	BLUE BOOK	11/11/19 7:30 am

Appraiser Code: Code that identifies the appraiser.

Average Value: Average value of the vehicle.

Retail Value: Retail value of the vehicle.

Source Publication: Source from which your organization obtained the appraisal (for example, Kelley Blue Book).

Appraisal Received: Date your organization received the appraisal.

Add an Appraisal

Use the **Add Appraisal** dialog box to add an appraisal of a vehicle.

To add an appraisal

1. In the **Reference Panel** navigation bar, click **Available Panels** and then click **Collateral**.
2. Click the tab for the collateral to modify, click the **Auction** tab, and then click the **Appraisals** tab.

Appraiser Code	Average Value	Retail Value	Source Publication	Appraisal Received
test	10	11	BLACK BOOK	11/12/19 5:00 am
TREV	123	230	BLUE BOOK	11/11/19 7:30 am

3. In the **Appraisals** toolbar, click **Add Appraisal**.

Add Appraisal

Appraiser Code	<input type="text"/>
Average Value	\$ <input type="text"/>
Retail Value	\$ <input type="text"/>
Source Publication	Select an option <input type="text"/>
Appraisal Received	<input type="text"/>

Appraiser Code: Code that identifies the appraiser.

Average Value: Average value of the vehicle.

Retail Value: Retail value of the vehicle.

Source Publication: Source from which your organization obtained the appraisal (for example, Kelley Blue Book).

Appraisal Received: Date your organization received the appraisal.

- Complete the information and then click **Save**.

Modify an Appraisal

Use the **Edit Appraisal** dialog box to modify an appraisal of a vehicle.

To modify an appraisal

- In the **Reference Panel** navigation bar, click **Available Panels** and then click **Collateral**.
- Click the tab for the collateral to modify, click the **Auction** tab, and then click the **Appraisals** tab.

Appraiser Code	Average Value	Retail Value	Source Publication	Appraisal Received
tsr	10	11	BLACK BOOK	11/12/19 5:00 am
TREV	123	230	BLUE BOOK	11/11/19 7:30 am

- In the **Appraisals** toolbar, click **Edit Appraisal**.

Edit Appraisal

Appraiser Code	TREW
Average Value	\$ 12560
Retail Value	\$ 1300
Source Publication	BLUE BOOK
Appraisal Received	11/11/2019

Appraiser Code: Code that identifies the appraiser.

Average Value: Average value of the vehicle.

Retail Value: Retail value of the vehicle.

Source Publication: Source from which your organization obtained the appraisal (for example, Kelley Blue Book).

Appraisal Received: Date your organization received the appraisal.

4. Modify the information and then click **Save**.

Purchase Bids

View Purchase Bids

Use the **Bids** tab on the **Auction** tab in the **Collateral** panel to view bids to purchase a vehicle.

To view purchase bids

1. In the **Reference Panel** navigation bar, click **Available Panels** and then click **Collateral**.
2. Click the tab for the collateral to modify, click the **Auction** tab, and then click the **Bids** tab.

Available Panels - Collateral						
Help						
47 New autos 48 Used autos 46 Recreational vehicle New Sample Real_Desc						
Collateral Repossession Auction Lease						
Main Repair Bids Appraisals Bids						
+ Add Bid Edit Bid						
Bid Date	Bid Received Amount	Counter Date	Counter Amount	Accepted Date	Accept Bid	Bidder Code
11/22/19 12:00 am	10	11/15/19 5:00 am	10	11/13/19 5:00 am	false	test
11/15/19 12:00 am	100	11/12/19 5:00 am	1001	11/11/19 5:00 am	true	10

Accept Bid: Indicates whether your organization accepted the bid.

Bidder Code: Code that identifies the bidder.

Bid Amount: Amount of the bid.

Bid Date: Date the buyer placed the bid.

Add a Purchase Bid

Use the **Add Bid** dialog box to add a bid to purchase a vehicle.

To add a purchase bid

1. In the **Reference Panel** navigation bar, click **Available Panels** and then click **Collateral**.
2. Click the tab for the collateral to modify, click the **Auction** tab, and then click the **Bids** tab.

Bid Date	Bid Received Amount	Counter Date	Counter Amount	Accepted Date	Accept Bid	Bidder Code
11/22/19 12:00 am	10	11/15/19 5:00 am	10	11/13/19 5:00 am	false	test
11/15/19 12:00 am	100	11/12/19 5:00 am	1001	11/11/19 5:00 am	true	10

3. In the **Bids** toolbar, click **Add Bid**.

Add Bid

Bid Date
 Bid Received Amount \$
 Counter Date
 Counter Amount \$
 Accepted Date
 Accept Bid
 Bidder Code

Bid Date: Date the buyer placed the bid.

Bid Received Amount: Amount of the bid.

Counter Date: Date your organization made a counter offer.

Counter Amount: Amount of the counter offer.

Accepted Date: Date your organization accepted the bid.

Accept Bid: If selected, your organization accepted the bid.

Bidder Code: Code that identifies the bidder.

4. Complete the information and then click **Save**.

Modify a Purchase Bid

Use the **Edit Bid** dialog box to modify a bid to purchase a vehicle.

To modify a purchase bid

1. In the **Reference Panel** navigation bar, click **Available Panels** and then click **Collateral**.
2. Click the tab for the collateral to modify, click the **Auction** tab, and then click the **Bids** tab.

Bid Date	Bid Received Amount	Counter Date	Counter Amount	Accepted Date	Accept Bid	Bidder Code
11/22/19 12:00 am	10	11/15/19 5:00 am	10	11/13/19 5:00 am	false	test
11/15/19 12:00 am	100	11/12/19 5:00 am	1001	11/11/19 5:00 am	true	10

- In the **Bids** toolbar, click **Edit Bid**.

Edit Bid

Bid Date	<input type="text" value="11/21/2019"/>
Bid Received Amount	<input type="text" value="\$ 8000"/>
Counter Date	<input type="text"/>
Counter Amount	<input type="text" value="\$"/>
Accepted Date	<input type="text"/>
Accept Bid	<input type="checkbox"/>
Bidder Code	<input type="text" value="FG2"/>

Bid Date: Date the buyer placed the bid.

Bid Received Amount: Amount of the bid.

Counter Date: Date your organized made a counter offer.

Counter Amount: Amount of the counter offer.

Accepted Date: Date the buyer accepted the counter offer.

Accept Bid: If selected, your organization accepted the bid.

Bidder Code: Code that identifies the bidder.

- Complete the information and then click **Save**.

Maintain Lease Information

Use the **Lease** tab in the **Collateral** panel to maintain lease information for a vehicle.

To maintain lease information

- In the **Reference Panel** navigation bar, click **Available Panels** and then click **Collateral**.
- Click the tab for the collateral to modify and then click the **Lease** tab.

Available Panels		Collateral		Help	
47 New autos	48 Used autos	46 Recreational vehicle	New Sample	Real_Desc	
Collateral	Repossession	Auction	Lease		
Lease					
Terms(Months):	<input type="text"/>	Original Miles:	<input type="text"/>	Contract Obligations:	\$ <input type="text"/>
Effective Date:	<input type="text"/>	Inception Miles:	<input type="text"/>	Security Deposit:	\$ <input type="text"/>
Maturity Date:	<input type="text"/>	Contract Miles:	<input type="text"/>	Residual:	\$ <input type="text"/>
Return Date:	<input type="text"/>	Purchase Miles:	<input type="text"/>	Residual Gain/Loss:	\$ <input type="text"/>
Disposition Date:	<input type="text"/>	End of Term Miles:	<input type="text"/>	Disposal Assessed Amount:	\$ <input type="text"/>
Inspection Received Date:	<input type="text"/>	Excess Miles:	<input type="text"/>	Unpaid Month Payment:	\$ <input type="text"/>
		Unused Miles:	<input type="text"/>	Unpaid Tax:	\$ <input type="text"/>
				Wear and Tear:	\$ <input type="text"/>
				Minor Wear Charge:	\$ <input type="text"/>
				Major Wear Charge:	\$ <input type="text"/>
				End of Term Tax Assessed:	\$ <input type="text"/>
				Excess Mileage:	\$ <input type="text"/>
				Mileage Credit:	\$ <input type="text"/>
				Other Tax Assessed:	\$ <input type="text"/>
<input type="button" value="Save"/>					

Term (Months): Length of the lease, in months.

Effective Date: Date the lease became effective.

Maturity Date: Date the lease matured.

Return Date: Date the leasing agency received the vehicle.

Disposition Date: Date the leasing agency determined the status of the returned vehicle.

Inspection Received Date: Date the leasing agency inspected the vehicle.

Original Miles: Original mileage on the leased vehicle.

Inception Miles: Mileage at the beginning of the lease term.

Contract Miles: Mileage allowed under the leasing contract.

Purchase Miles: Number of extra miles purchased.

End of Term Miles: Mileage at the end of the lease term.

Excess Miles: Number of miles over the contract and purchased miles.

Unused Miles: Number of unused contract and purchased miles.

Contract Obligation: Total amount due under the lease agreement. This amount excludes the security deposit, sales tax, and any other fees and taxes paid to a third party.

Security Deposit: Amount the lessee paid as a security deposit.

Residual: Lease-end value of the vehicle.

Residual Gain/Loss: Difference between the residual value and the end-of-lease purchase price.

Disposal Assessed Amount: Amount charged to dispose of the vehicle.

Unpaid Month Payment: Number of months during the lease term that the lessee did not make a payment.

Unpaid Tax: Amount in unpaid taxes that the lessee owes.

Wear and Tear: Total amount charged for wear and tear on the vehicle.

Minor Wear Charge: Amount charged for minor wear on the vehicle.

Major Wear Charge: Amount charged for major wear on the vehicle.

End of Term Tax Assessed: Tax assessed at the end of the lease.

Excess Mileage: Amount charged for each mile over the mileage limit.

Mileage Credit: Amount credited for unused mileage.

Other Tax Assessed: Amount charged for other taxes (for example, property tax).

3. Complete the information and then click **Save**.

Maintain Real Estate Collateral

Use the **Real Estate** tab in the **Collateral** panel to maintain collateral information for real estate properties.

To maintain real estate collateral

1. In the **Reference Panel** navigation bar, click **Available Panels** and then click **Collateral**.
2. Click the tab for the collateral to modify. The **Real Estate** tab appears.

The screenshot shows a software interface for managing collateral. At the top, there is a navigation bar with 'Available Panels' and 'Collateral'. Below this is a sub-navigation bar with tabs for '47 New autos', '48 Used autos', '46 Recreational vehicle', 'New Sample', and 'Real_Desc'. The 'Real Estate' tab is selected. The main area contains a grid of input fields for various data points, including dates, monetary values, and text descriptions. A 'Save' button is located at the bottom left of the form area.

Appraisal Ordered Date: Date the lender ordered an appraisal of the property.

SCRA Ordered Date: Date the lender obtained a court order to foreclose on the property as required under the Servicemembers Civil Relief Act.

Foreclosure Bid Amount: Amount the lender bid on the property at the foreclosure sale.

Internal Lien Position: Your organization's position in line in regard to benefitting from collateral liquidation. The senior position is first in line to benefit.

1st Mortgage Holder: Lender who holds the first mortgage.

Other Lien Holder Position: Position in line of other lien holders in regard to benefitting from collateral liquidation. The senior position is first in line to benefit.

1st Mortgage Balance: Balance due on the first mortgage.

Attorney Phone: Phone number of the lender's attorney.

Date Sent for Foreclosure: Date the lender sent the paperwork to the attorney to start the foreclosure process.

Attorney Demand Sent: Date the attorney sent notice to the borrower demanding that the borrower return the loan to good standing.

Attorney Demand Expiration Date: Date the demand notice expires. If the borrower doesn't pay the amount specified in the demand letter, the lender starts the foreclosure process.

Complaint filed Date: Date the lender's attorney filed a complaint for foreclosure with the court.

Foreclosure Service Date: Date the court served the borrower with the complaint for foreclosure document and a summons.

Foreclosure Sale Date: Date the sheriff scheduled an auction to sell the property.

Sequence: Client internal identifier for each piece of collateral.

Judgment Date: Date the court entered a final judgment of foreclosure against the borrower.

Foreclosure Resolution Date: Date the lender recovered the balance of the loan by forcing the sale of the asset used as collateral for the loan.

Deed Recording Date: Date the recorder or clerk recorded the sheriff's deed.

Sale Confirmation Date: Date the court approved the terms, price, and conditions of the sale.

FRB Code: Code that identifies the Federal Reserve Bank in which the lender is a member.

CB Special Comment: Credit Bureau special comment.

Deed in Lieu: Indicates whether the borrower conveyed all interest in the property to the lender to satisfy the loan and avoid foreclosure proceedings.

Type of Sale: Indicates whether the foreclosure sale is judicial (through a court process) or non-judicial (without a court's involvement).

Forced-placed Insurance: Indicates whether the lender placed an insurance policy on the property.

Property: Property occupancy, such as vacant or occupied.

PMI: Indicates whether the borrower has private mortgage insurance on the property loan.

Date of Appraisal: Date an appraiser appraised the property.

Breach Letter Date: Date the lender sent a breach letter to the borrower to notify the borrower that the loan is in default.

Property Type: Type of property, such as single family residence or raw land.

Original Value: Original appraised value of the property.

Status: Current status of the property.

Current Value: Current appraised value of the property.

FREM Loan Number: Number that First Real Estate Mortgage assigned to identify the loan.

FREM Customer Name: Name of the First Real Estate Mortgage customer.

FREM Collateral Description: Description of the First Real Estate Mortgage loan collateral.

FREM Note Date: Date the borrower signed the First Real Estate Mortgage note.

FREM Due Date: Date the First Real Estate Mortgage loan payment is due.

FREM Original Balance: Original First Real Estate Mortgage loan balance.

FREM Current Balance: Current First Real Estate Mortgage loan balance.

FREM Original Value: First Real Estate Mortgage's original appraised value of the property.

FREM Current Value: First Real Estate Mortgage's current appraised value of the property.

Judgment Amount: Total amount that the court awarded to the lender.

Property Address: Property's house number, street, city, state, and ZIP code.

Attorney Name: Name of the borrower's attorney.

2nd Mortgage Subject to First Mortgage: Indicates whether the borrower has a second mortgage on the property.

1099 A Filed Date: Date the lender filed a 1099-A with the IRS for the property foreclosure.

1099 C Filed Date: Date the lender filed a 1099-C with the IRS for the acquisition of the secured property (or the debtor's abandonment of the property) and cancellation of the debt.

Occupant Code: Code that identifies the property's usage.

Foreclosure Code: Code that identifies the foreclosure type.

Communication

Communication

Use the **Communication** panel to view historical communication for the account. If a call has an audio recording associated to it, you can play the recording. If a letter has a file associated to it, you can view the letter.

Available communications are:

- Outbound call initiated manually within Latitude or through a desktop phone
- Outbound call initiated through a Dialer calling list
- Inbound call from the customer delivered through the Dialer or a desktop phone
- Written communication or electronic message, such as:
 - Outbound letter sent from within Latitude
 - Outbound letter sent from outside Latitude that a user attached to the account
 - Inbound document that a user attached to the account

View Account Communications

Use the **Communication** panel to view communication activities associated to the account.

To view account communications

1. In the **Reference Panel** navigation bar, click **Available Panels** and then click **Communication**.

Date	User	Type	Party	Description
9/3/19 8:37 pm	GSadmin	ManualCallDispositioned	Willie Davis	Manual Call to +13175589633 Home result LM (Not Set)
9/3/19 8:30 pm	GSadmin	CampaignCallDispositioned	Willie Davis	Campaign Call to +12157329143 Work result DK (Not Set)
9/3/19 8:29 pm	GSadmin	CampaignCallDispositioned	Willie Davis	Campaign Call to +13175589633 Home result TT (Not Set)
8/30/19 11:09 pm	Pam Briggs	CampaignCallDispositioned	Willie Davis	Campaign Call to +13175589633 Home result CO (Not Set)

Filter by:

Type: If selected, only displays communications that match the specified communication type.

Party: If selected, only displays communications for the specified party.

Clear Filters: Clears the specified filters and displays all communications.

Date: Date and time the communication occurred. To change the sort order, click the arrow in the Date column heading.

User: ID and name of the user associated to the communication.

Type: Type of communication.

Party: Name of the party who received the communication from or sent the communication to your organization.

Description: Description of the communication.

2. To filter communications, do the following:
 - To display communications for a specific communication type, in the **Type** box in the **Communication** panel toolbar, click the communication type. Only communications that match the specified type appear in the panel.
 - To display communications for a specific party, in the **Party** box in the **Communication** panel toolbar, click the party. Only communications for the specified party appear in the panel.

Tip: To clear the filter and display all communications, click **Clear Filters**.

Play a Call Recording

Use the **Play Recordings** dialog box to play an audio recording of a call. A tone within a recording marks the place where the recording paused.

To play a call recording

1. In the **Reference Panel** navigation bar, click **Available Panels** and then click **Communication**.

Latitude Printable Help



Date	User	Type	Party	Description
9/3/19 8:30 pm	GSAdmin	CampaignCallDispositioned	Willie Davis	Campaign Call to +12157329143 Work result DK (Not Set)
9/3/19 8:29 pm	GSAdmin	CampaignCallDispositioned	Willie Davis	Campaign Call to +13175589633 Home result TT (Not Set)
8/30/19 11:09 pm	Pam Briggs	CampaignCallDispositioned	Willie Davis	Campaign Call to +13175589633 Home result CO (Not Set)

If a call has a recording associated to it, a Folder image appears in the **Type** column.

2. In the data grid, click the communication to play and then click **Play/View**. The **Play Recordings** dialog box appears.

Play Recordings

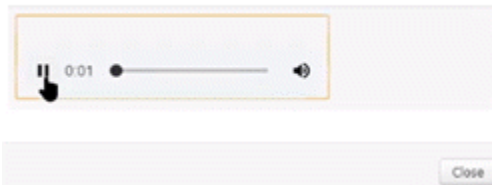

3. When finished, click **Close**.

View a Sent Letter

Use the **Communication** panel to view a letter that a user sent to a party on the account. If a user didn't save the letter output when sending the letter, the option to view the letter file isn't available.

To view a sent letter

1. In the **Reference Panel** navigation bar, click **Available Panels** and then click **Communication**.



Date	User	Type	Party	Description
9/3/19 8:30 pm	GSAdmin	CampaignCallDispositioned	Willie Davis	Campaign Call to +12157329143 Work result DK (Not Set)
9/3/19 8:29 pm	GSAdmin	CampaignCallDispositioned	Willie Davis	Campaign Call to +13175589633 Home result TT (Not Set)
8/30/19 11:09 pm	Pam Briggs	CampaignCallDispositioned	Willie Davis	Campaign Call to +13175589633 Home result CO (Not Set)

If a sent letter has an output file associated to it, a Folder image appears in the **Type** column.

2. In the data grid, click the letter to view and then click **Play/View**. The letter appears minimized beneath the status bar.
3. Click the letter to open it in the associated program (for example, Word or Adobe Acrobat Reader).

View Interaction Details for a Communication

Use the **Interactions** panel to view the interaction details associated to a communication regarding the account.

To view interaction details for a communication

1. In the **Reference Panel** navigation bar, click **Available Panels** and then click **Communication**.

Available Panels ▾					
Filter By: Type <input type="text"/> Party <input type="text"/> Clear Filters					
Date	User	Type	Party	Description	
9/3/19 8:30 pm	GSadmin	CampaignCallDispositioned	Willie Davis	Campaign Call to +12157329143 Work result DK (Not Set)	
9/3/19 8:29 pm	GSadmin	CampaignCallDispositioned	Willie Davis	Campaign Call to +13175589633 Home result TT (Not Set)	
8/30/19 11:09 pm	Pam Briggs	CampaignCallDispositioned	Willie Davis	Campaign Call to +13175589633 Home result CO (Not Set)	

Play/View Interaction

- In the data grid, click the communication and then click **Interaction**. The **Interactions** panel opens to the entry associated to the communication.

Date	User	Account	Event	Detail
9/3/19 8:28 pm	GSadmin	1006	Interaction Started	
9/3/19 8:29 pm	GSadmin	1006	Campaign Call Dispositioned	Campaign Call to XXXXXXXXX0633
9/3/19 8:29 pm	GSadmin	1006	Account Worked	Account considered as Worked
9/3/19 8:29 pm	GSadmin	1006	Account Contacted	Contact Contacted
9/3/19 8:29 pm	GSadmin	1006	Account Attempted	Contact Attempted
9/3/19 8:29 pm	GSadmin	1006	Party Phone Number Attempted	Party Willie Davis - Phone Number Home
9/3/19 8:29 pm	GSadmin	1006	Interaction Completed	

Credit Bureau Reporting

Credit Bureau Reporting

Use the **CB Reporting** panel to view pending and historical credit bureau reporting information for the responsible parties on the account. You can also manage reporting of accounts to credit bureaus.

Reporting files

Latitude credit reporting files are in compliance with the Metro2 reporting guidelines.

- Metro2 file is in 426 character format, variable length.
- Responsible parties are in the J2 segments of the Metro2 file.
- Original creditor information is in the K1 segment of the Metro2 file.

Reporting options

Depending on your system configuration, you can:

- Report principal only, instead of the total account balance.
- Report responsible parties, instead of just the primary customer on the account.
- Extend the reporting of an account beyond the configured wait days. This feature allows you to suspend reporting while you are in negotiations with a customer.
- Flag returned accounts for deletion from the credit bureaus.

Configure a Responsible Party for Credit Reporting

To include a responsible party in credit bureau reporting, the system requires certain settings.

To configure a responsible party for credit reporting

1. On the **Contact Information** tab in the **Customer** panel, ensure that the responsible party to report has the following settings:
 - **Relation to Account** list box is set to "Debtor" for the primary responsible party and "Co-debtor" for secondary responsible parties.
 - **Is Responsible** box is set to "Yes" or the check box is selected.
 - **National ID** box is populated with a valid social security number.
2. On the **Address** panel, ensure that the responsible party to report has the following settings:
 - **Type of Address** list box is set to "Home."
 - **Status of Address** list box is set to "Good."
 - **Active** check box is selected.
 - **Primary** check box is selected.
 - **Correspondence** check box is selected.
 - **Address Line 1, City/Town, State, and Post Code** boxes have a valid address.
3. On the **Customer Configuration** pane in Credit Bureau Reporting Console, ensure that **Include codebtors** check box is selected.

View Credit Bureau Reporting Summary

Use the **Summary** tab on the **CB Reporting** panel to view pending and historical credit bureau reporting summary for a responsible party on the account.

To view credit bureau reporting summary

1. In the **Reference Panel** navigation bar, click **Available Panels** and then click **CB Reporting**.
2. Click the **Summary** tab.

Available Panels ▾ CB Reporting ✕

View History Pending Record ▾ Help

Summary Account Information Audit Utility

Exceptions

- No Exceptions to display

Reporting Status

Credit Bureaus		Next Update	
Account	1840	Last Evaluated	7/18/17
Last Reported	7/18/17	Last Updated	7/18/17
Status:	<ul style="list-style-type: none"> I am the the Account Reported Message 	Status:	<ul style="list-style-type: none"> I am the Account Pending Message

Debtor	Credit Bureau Status	Next Update Status
Orlando Sloan (PRIMARY)	<ul style="list-style-type: none"> I am the Debtor Reported Message 	<ul style="list-style-type: none"> I am the Debtor Pending Message
Mira Sloan	<ul style="list-style-type: none"> I am the Debtor Reported Message 	<ul style="list-style-type: none"> I am the Debtor Pending Message

Delete Delete as Fraud Evaluate Account

DB Server Name: localhost Database: Collect2000 Previous Login: Jul 18, 2017 8:08:31 am Time on Account: 00:04:58

Exceptions

Debtor: Unique code that identifies the customer on the account. This value displays for debtor exception types only.

Description: Description of the exception.

Reporting Status

Note: If insurance is paying or paid the medical debt in full, the message, "Prevent Flag is ON," appears in this section.

Account: Code that Latitude assigned to identify the account.

Last Reported: Date your organization last reported the account to the credit bureaus.

Status: Status of the last report to the credit bureaus.

Last Evaluated: Last date the system evaluated the account for credit bureau reporting purposes.

Last Updated: Date the system or a user last updated the account.

Status: Status of the next report to the credit bureaus.

Debtor: Name of the customer on the account. If the customer is the primary party on the account, the system displays "(PRIMARY)" next to the customer's name.

Credit Bureau Status: Status of the last report to the credit bureaus.

Next Update Status: Status of the next report to the credit bureaus.

- In the **View History** list box, click the type of record to view (pending or historical).

View Credit Bureau Reporting Account Information

Use the **Account Information** tab on the **CB Reporting** panel to view pending and historical credit bureau reporting information for a responsible party on the account.

To view credit bureau reporting account information

1. In the **Reference Panel** navigation bar, click **Available Panels** and then click **CB Reporting**.
2. Click the **Account Information** tab.

View History: Type of credit bureau reporting information to display.

Account ID: Code that the system assigned to identify the account.

Customer ID: Code that identifies the client on the account.

Primary Debtor: Code that identifies the primary customer on the account.

Portfolio Type: Code that identifies the portfolio to which the account belongs. For more information, see [Portfolio Types](#).

Account Type: Code that identifies the account type, such as collection agency or business credit card. For more information, see [Account Types](#).

Account Status: Code that identifies the reporting status of the account, such as assigned to internal or external collections. For more information, see [CBR Account Status Codes](#).

Special Comment: Code that identifies a note about the account, such as "debt paid through insurance." For more information, see [Special Comment Codes](#).

Consumer Account: Code that the client assigned to identify the account.

Last Updated: Date the system or a user last updated the account.

Last Reported: Date the system or a user last reported the account to a credit bureau.

Compliance Condition: Code that identifies the compliance condition, such as "account information disputed by consumer under FCRA." For more information, see [Compliance Condition Codes](#).

Original Loan: Original loan amount.

Actual Payment: Monthly payment amount.

Current Balance: Current balance on the account.

Amount Past Due: Amount of the current balance that is past due.

Terms Duration: Terms for repayment of the account, such as number of months.

Original Creditor: Original creditor assigned to the account.

Creditor Class: Class of business assigned to the account for reporting to credit bureaus. For more information, see [Creditor Classification Code](#).

Credit Limit: Maximum credit amount granted to the customer.

Charge-off Amount: Amount of the customer's debt that the client charged off.

Billing Date: Date the client billed the customer.

Delinquency Date: Date the account became delinquent.

Closed Date: Date the system or a user closed the account.

Last Payment: Amount the customer last paid on the account.

History Date: Date the system posted the payment history.

Payment History: Payment history codes that identify the monthly payment status for the past 24 months (for example, 30 days late).

Wait Days: Number of days to wait after receiving an account before reporting it to the credit bureaus.

Extend Days: Number of days to delay reporting an account to the credit bureaus.

[Name] tab: Displays a separate tab for each reported party on the account. The first tab with the Person icon is the primary party on the account.

Name: Party's full name.

Last: Party's last name.

First: Party's first name.

Middle: Party's middle name.

Suffix: Party's name suffix.

SSN: Party's Social Security Number.

Date of Birth: Party's date of birth.

Phone: Party's phone number.

Address: Party's street address.

City, State, Zip: Party's city, state, and postal code.

Country: Country where the party resides.

Transaction Type: Code that identifies the type of account transaction, along with a description. If you can't see the entire description, rest your mouse on the **Transaction Type** box. For more information, see [Transaction Types](#).

ECOA Code: Equal Credit Opportunity Act code that identifies who is responsible for repayment of the debt, such as individual or joint. For more information, see [ECOA Codes](#).

Information Indicator: Credit bureau consumer information indicator, such as reaffirmation of debt or petition for Chapter 7 bankruptcy.

Address Indicator: Type of address, such as home, business, or military. For more information, see [Address Indicator](#).

Residence Code: Residence status, such as owns or rents. For more information, see [Residence Codes](#).

Last Updated: Date of the last update on the account.

Tip: To view the entire contents of a box when they aren't visible (for example, **Account Status**), rest your mouse on the box.

3. In the **View History** list box, click the type of record to view (pending or historical).
4. To view another party on the account, click the tab that corresponds to the party's name.
5. To modify the compliance condition, in the **Compliance Condition** list box, click the condition and then click **Save**.

View Credit Bureau Reporting Audit Trail

Use the **Audit** tab on the **CB Reporting** panel to view the credit bureau reporting audit trail for the account.

To view the credit bureau reporting audit trail

1. In the **Reference Panel** navigation bar, click **Available Panels** and then click **CB Reporting**.
2. Click the **Audit** tab.

Available Panels ▾ CB Reporting ✕	
View History Pending Record ▾ Help	
Summary Account Information Audit Utility	
Entered	Comment
7/18/17	Account 1840 evaluated.
7/18/17	(I)initial 93generated - 48
7/18/17	Account fraud, deletion submitted in credit bureau report file.
7/18/17	Account update will be sent to credit bureaus in next update.
7/18/17	Removed Account 1840 from credit bureau report.
6/2/17	(I)initial 93generated - 48
6/2/17	Account removed from pending - Exception raised on account. See Cbr_Exceptions.
6/2/17	Statute of limitations exceeded.
6/2/17	Account removed from pending - Exception raised on account. See Cbr_Exceptions.
6/2/17	Statute of limitations exceeded.
6/2/17	Account removed from pending - Exception raised on account. See Cbr_Exceptions.
6/2/17	Statute of limitations exceeded.
6/2/17	Account removed from pending - Exception raised on account. See Cbr_Exceptions.
6/2/17	Statute of limitations exceeded.
6/2/17	Account removed from pending - Exception raised on account. See Cbr_Exceptions.
6/2/17	Statute of limitations exceeded.
1/14/17	Account update will be sent to credit bureaus in next update.
6/8/16	Account update will be sent to credit bureaus in next update.
6/8/16	Account placed in pending for the next credit bureau report. AccountType - 48
DB Server Name: localhost Database: Collect2000 Previous Login: Jun 2, 2017 2:48:11 pm Time on Account: 00:08:50	

Entered: Date the system added the audit record.

Comment: Description of the audit trail entry. If this box includes the message, "See Cbr_Exceptions," the system added details to the CBR_Exceptions table. For assistance with viewing the table, see your System Administrator.

Manage Miscellaneous CBR Settings

Use the **Utility** tab on the **CB Reporting** panel to manage miscellaneous credit bureau reporting settings for the account. You can specify whether an account is under a voluntary debt repayment plan filed in Wisconsin (Chapter 128) and whether the customer withdrew a filed bankruptcy. For first-party accounts, you can remove an authorized party from the account entirely. An authorized party has authorization from the primary customer to use a credit card or other device. You must have the Utility Tab permission.

To manage miscellaneous CBR settings

1. In the **Reference Panel** navigation bar, click **Available Panels** and then click **CB Reporting**.
2. Click the **Audit** tab.

The screenshot shows the 'CB Reporting' panel with the 'Summary' tab selected. The 'Personal Receivership/Amortization' checkbox is checked. The 'Bankruptcy Withdrawn' checkbox is also checked. A date input field is present next to the 'Bankruptcy Withdrawn' checkbox. A 'Terminate Authorized User' button is visible on the right side of the panel. A 'Save' button is located at the bottom of the panel.

Personal Receivership/Amortization: If selected, the account is under a voluntary debt repayment plan filed in Wisconsin (Chapter 128).

Bankruptcy Withdrawn: If selected, the customer withdrew a filed bankruptcy. This check box only appears for accounts reported to the credit bureaus as a bankruptcy.

[Bankruptcy Withdrawn Date]: Date the customer withdrew the filed bankruptcy. This box only appears for accounts reported to the credit bureaus as a bankruptcy.

[Authorized User Name]: List of authorized users on the account.

Terminate Authorized User: Removes an authorized party and all the party's information from the account. This option only appears for first-party accounts that have an authorized party on the account.

3. To modify the personal receivership/amortization, do one of the following:
 - If the account is under a voluntary debt repayment plan filed in Wisconsin (Chapter 128), select the **Personal Receivership/Amortization** check box.
 - If the account is no longer under a voluntary debt repayment plan filed in Wisconsin (Chapter 128), clear the **Personal Receivership/Amortization** check box.
4. If the account reported to the credit bureaus as a bankruptcy and the customer withdrew the bankruptcy, do the following:
 - a. Select the **Bankruptcy Withdrawn** check box.
 - b. In the **[Bankruptcy Withdrawn Date]** box, specify the date the customer withdrew the bankruptcy.
5. To remove an authorized user from the account, do the following:
 - a. In the **[Authorized User Name]** drop-down, click the name of the authorized user to remove from the account.
 - a. Click **Terminate Authorized User**. The system removes the authorized user and all the user's information from the account.

Report an Account to Credit Bureaus

Use the **Summary** tab on the **CB Reporting** panel to report the account to credit bureaus when a report is not due. When reporting accounts to credit bureaus, ensure that your organization is in compliance with Federal and State laws regarding credit reporting.

To report an account to credit bureaus

1. In the **Reference Panel** navigation bar, click **Available Panels** and then click **CB Reporting**.

- Click the **Summary** tab.

Available Panels ▾ Notes ✕ CB Reporting ✕

View History Pending Record ▾ Help

Summary Account Information Audit Utility

Exceptions

- No Exceptions to display

Reporting Status

Credit Bureaus		Next Update	
Account	2424	Last Evaluated	7/18/17
Last Reported		Last Updated	7/18/17
Status:	<ul style="list-style-type: none"> I am the the Account Reported Message 	Status:	<ul style="list-style-type: none"> I am the Account Pending Message

Debtor	Credit Bureau Status	Next Update Status
Kay Morgan (PRIMARY)	<ul style="list-style-type: none"> I am the Debtor Reported Message 	<ul style="list-style-type: none"> I am the Debtor Pending Message

Report Extend Evaluate Account

DB Server Name: localhost Database: Collect2000 Previous Login: Jul 18, 2017 10:34:31 am Time on Account: 00:00:34

- Click **Report**. The system includes the account in the next file that you create and send to the credit bureaus.

Delay Reporting an Account to Credit Bureaus

Use the **Extend Days** dialog box to extend the number of days to delay reporting the account to credit bureaus. This option is available when reporting an account for the first time only.

To delay reporting an account to credit bureaus

- In the **Reference Panel** navigation bar, click **Available Panels** and then click **CB Reporting**.
- Click the **Summary** tab.

The screenshot shows the 'CB Reporting' interface. At the top, there are tabs for 'Available Panels' and 'CB Reporting'. Below that, there are buttons for 'View History' and 'Pending Record', along with a 'Help' icon. The main content area is divided into several sections:

- Summary**: Includes buttons for 'Account Information', 'Audit', and 'Utility'.
- Exceptions**: A table with columns 'Debtor' and 'Description'. The row shows 'Account' and 'OutofStatute'.
- Reporting Status**: A table with columns 'Credit Bureaus' and 'Next Update'. The row shows 'Account 1005', 'Last Evaluated 7/18/17', and 'Last Reported'. Below this, there are status lists for 'Status:'.
- Debtors**: A table with columns 'Debtor', 'Credit Bureau Status', and 'Next Update Status'. The row shows 'Roy Wiesen (PRIMARY)', 'I am the Debtor Reported Message', and 'I am the Debtor Pending Message'.

At the bottom of the interface, there are buttons for 'Report', 'Extend', and 'Evaluate Account'. A footer bar contains system information: 'DB Server Name: localhost | Database: Collect2000 | Previous Login: Jun 2, 2017 2:48:11 pm | Time on Account: 00:00:43'.

3. Click **Extend**.

Extend Days

Enter the number of days you wish to extend the delay of reporting this account to the credit bureaus.

Received Date	<input type="text" value="4/23/12"/>
Wait Days	<input type="text" value="2"/>
Extension	<input type="text" value="0"/>
Report Date	<input type="text" value="4/25/12"/>

Received Date: Date your organization received the account.

Wait Days: Number of days after receiving the account to wait before reporting the account to the credit bureaus.

Extension: Number of days beyond the "wait days" to delay reporting the account to the credit bureaus.

Report Date: Date to report the account to the credit bureaus.

4. In the **Extension** box, type the number of days beyond the "wait days" to delay reporting.
5. Click **OK**.

Evaluate an Account for Credit Reporting

Use the **Summary** tab in the **CB Reporting** panel to evaluate the account for credit bureau reporting purposes. This process evaluates the account for actions such as a user included a responsible party in reporting or flagged a responsible party as deceased. You must have the Allow Manual Evaluation Permission.

Note: If you have a large database, this process is time-consuming so use it sparingly. Keep in mind that Custodian also runs this process automatically each night so you may want to skip the manual evaluation.

To evaluate an account for credit reporting

1. In the **Reference Panel** navigation bar, click **Available Panels** and then click **CB Reporting**.
2. Click the **Summary** tab.

The screenshot shows the 'CB Reporting' panel with the 'Summary' tab selected. The 'Reporting Status' section contains two tables:

Credit Bureaus		Next Update	
Account	1840	Last Evaluated	7/18/17
Last Reported	7/18/17	Last Updated	7/18/17
Status:	<ul style="list-style-type: none"> I am the the Account Reported Message 	Status:	<ul style="list-style-type: none"> I am the Account Pending Message

Debtor	Credit Bureau Status	Next Update Status
Orlando Sloan (PRIMARY)	<ul style="list-style-type: none"> I am the Debtor Reported Message 	<ul style="list-style-type: none"> I am the Debtor Pending Message
Mira Sloan	<ul style="list-style-type: none"> I am the Debtor Reported Message 	<ul style="list-style-type: none"> I am the Debtor Pending Message

At the bottom of the interface, there are buttons for 'Delete', 'Delete as Fraud', and 'Evaluate Account'.

3. Click **Evaluate Account**. The system displays a message indicating that the evaluation started. When finished, it displays a message indicating that the evaluation completed.

Remove a Responsible Party From Credit Bureau Reporting

Use the **Account Information** tab on the **CB Reporting** panel to remove a responsible party associated to the account from credit bureau reporting.

To remove a responsible party from credit bureau reporting

1. In the **Reference Panel** navigation bar, click **Available Panels** and then click **CB Reporting**.
2. Click the **Account Information** tab.

Latitude Printable Help

Available Panels ▾		Notes ✕		CB Reporting ✕		
View History					Pending Record ▾	Help
Summary		Account Information		Audit		Utility
Account Id	1840	Compliance Condition		Billing Date	7/18/17	
Customer Id	16	Original Loan	\$10,000.00	Delinquency Date	1/23/12	
Primary Debtor	1143	Actual Payment	\$0.00	Closed Date		
Portfolio Type	0	Current Balance	\$10,000.00	Last Payment		
Account Type	48 - Collection Agency/Attorney	Amount Past Due	\$10,000.00	History Date	6/30/17	
Account Status	93 - Account assigned to internal	Terms Duration	001	Payment History		
Special Comment		Original Creditor	Sodin Bank and Trust	Wait Days	1	
Consumer Account	1840	Creditor Class	01	Extend Days	0	
Last Updated	7/18/17	Credit Limit	\$0.00			
Last Reported		Charge-off Amount	0			
Sloan, Orlando		Sloan, Mira				
Name	Sloan, Orlando	Date of Birth	10/25/59	ECOA Code	2 - Joint Contractual Liability	
Last	Sloan	Phone	+17849922586	Information Indicator		
First	Orlando	Address	80 Fablen St.	Address Indicator	N - Not confirmed address	
Middle		City, State, Zip	Albuquerque, WA 90512	Residence Code		
Suffix		Country	US	Last Updated	7/18/17	
SSN	000640108	Transaction Type				
Save						
DB Server Name: localhost Database: Collect2000 Previous Login: Jul 18, 2017 8:08:31 am Time on Account: 00:02:19						

- Click the tab that corresponds to the party's name.

Available Panels ▾		Notes ✕		CB Reporting ✕	
View History		Pending Record ▾		Help	
Summary		Account Information		Audit	
Utility					
Account Id	1840	Compliance Condition		Billing Date	7/18/17
Customer Id	16	Original Loan	\$10,000.00	Delinquency Date	1/23/12
Primary Debtor	1143	Actual Payment	\$0.00	Closed Date	
Portfolio Type	0	Current Balance	\$10,000.00	Last Payment	
Account Type	48 - Collection Agency/Attorney	Amount Past Due	\$10,000.00	History Date	6/30/17
Account Status	93 - Account assigned to internal	Terms Duration	001	Payment History	
Special Comment		Original Creditor	Sodin Bank and Trust	Wait Days	1
Consumer Account	1840	Creditor Class	01	Extend Days	0
Last Updated	7/18/17	Credit Limit	\$0.00		
Last Reported		Charge-off Amount	0		
Sloan, Orlando		Sloan, Mira			
Name	Sloan, Mira	Date of Birth	9/1/65	ECOA Code	2 - Joint Contractual Liability
Last	Sloan	Phone		Information Indicator	
First	Mira	Address	80 Fablen ST	Address Indicator	N - Not confirmed address
Middle		City, State, Zip	Albuquerque, WA 90521	Residence Code	
Suffix		Country	US	Last Updated	7/18/17
SSN	55555555	Transaction Type	1 - Newly opened account, or new	<input type="button" value="✕ Remove Debtor: Sloan, Mira"/>	
<input type="button" value="Save"/>					
DB Server Name: localhost Database: Collect2000 Previous Login: Jul 18, 2017 8:08:31 am Time on Account: 00:03:54					

4. Click **Remove Debtor - [Debtor Name]**.
5. In the confirmation dialog box, click **OK**. The system adds an audit trail record to Latitude.
6. In the **Task Panel** navigation tree, click **Customer** and then click the party's name.
7. Clear the **Is Responsible** check box and then click **Save**.

Send Delete Request for Account Reported in Error

Use the **Summary** tab on the **CB Reporting** panel to send a delete request to the credit bureaus for the account. You can send the delete request if the account reported previously and one of the following is true:

- Account reported in error.
- Agency closed and returned the account to the creditor.
- Debt buyer forwarded or sold the account.
- Account reported as disputed and your agency couldn't verify the dispute before the FCRA 30-day window.
- Customer is deceased and no other party on the account is responsible for the account.
- Responsible party has a discharged bankruptcy Chapter 7 or is in a Chapter 13 repayment plan currently.

You must have the Allow Delete Options Permission.

To send delete request for account reported in error

1. In the **Reference Panel** navigation bar, click **Available Panels** and then click **CB Reporting**.
2. Click the **Summary** tab.

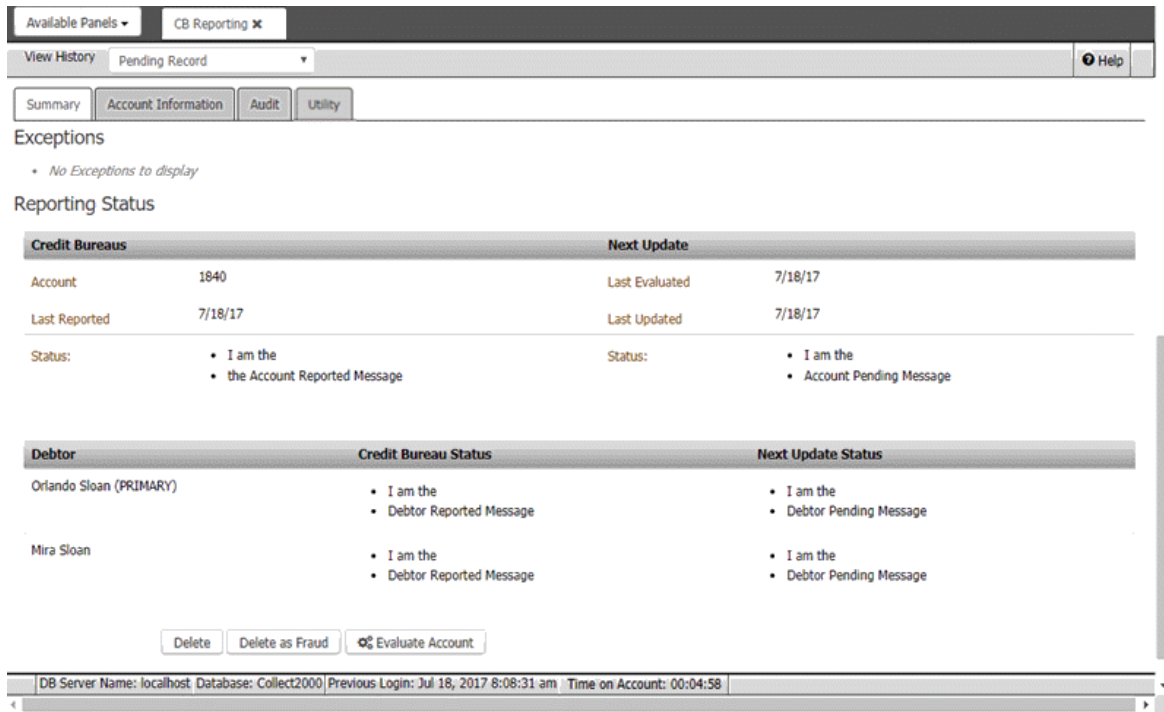

3. Click **Delete**.
4. In the confirmation dialog box, click **OK**. The system displays a message indicating that the account is deleted from reporting and adds an audit trail record. The system sends a delete request for the account in the next CBR file that your organization creates and excludes the account from subsequent credit reporting.

Note: If you remove the account from reporting and the account is not yet reported, you can undo the delete. For more information, see [Undo a Credit Reporting Delete Request](#).

Send Delete Request for Account Reported Based on Fraud

Use the **Summary** tab on the **CB Reporting** panel to send a delete request to the credit bureaus for the account. You can send the delete request when the customer is a victim of fraud and the account reported previously. You must have the Allow Delete Options Permission.

To send delete request for account reported based on fraud

1. In the **Reference Panel** navigation bar, click **Available Panels** and then click **CB Reporting**.
2. Click the **Summary** tab.

The screenshot shows the 'CB Reporting' panel with the 'Summary' tab selected. The 'Reporting Status' section contains two tables. The first table, 'Credit Bureaus', shows account details for account 1840, including the last reported date (7/18/17) and next update date (7/18/17). The second table, 'Debtor', lists debtors Orlando Sloan (PRIMARY) and Mira Sloan, along with their credit bureau status and next update status. At the bottom of the debtor table, there are three buttons: 'Delete', 'Delete as Fraud', and 'Evaluate Account'.

Credit Bureaus		Next Update	
Account	1840	Last Evaluated	7/18/17
Last Reported	7/18/17	Last Updated	7/18/17
Status:	<ul style="list-style-type: none"> I am the the Account Reported Message 	Status:	<ul style="list-style-type: none"> I am the Account Pending Message

Debtor	Credit Bureau Status	Next Update Status
Orlando Sloan (PRIMARY)	<ul style="list-style-type: none"> I am the Debtor Reported Message 	<ul style="list-style-type: none"> I am the Debtor Pending Message
Mira Sloan	<ul style="list-style-type: none"> I am the Debtor Reported Message 	<ul style="list-style-type: none"> I am the Debtor Pending Message

Buttons: Delete, Delete as Fraud, Evaluate Account

DB Server Name: localhost Database: Collect2000 Previous Login: Jul 18, 2017 8:08:31 am Time on Account: 00:04:58

3. Click **Delete as Fraud**.
4. In the confirmation dialog box, click **OK**. The system displays a message indicating that the account is deleted from reporting and adds an audit trail record. The system sends a delete request for the account in the next CBR file that your organization creates and excludes the account from subsequent credit reporting.

Note: If you remove the account from reporting and the account is not yet reported, you can undo the delete. For more information, see [Undo a Credit Reporting Delete Request](#).

Send Delete Request for Medical Account

Use the **Summary** tab on the **CB Reporting** panel to send a delete request to the credit bureaus for the account. You can send the delete request when insurance is paying or paid the medical debt in full and the account reported previously. You must have the Allow Delete Options Permission..

To send delete request for medical account

1. In the **Reference Panel** navigation bar, click **Available Panels** and then click **CB Reporting**.
2. Click the **Summary** tab.

The screenshot shows the 'CB Reporting' interface. At the top, there is a navigation bar with 'Available Panels' and 'CB Reporting'. Below this is a 'View History' section with a dropdown menu set to 'Pending Record' and a 'Help' icon. The main content area has tabs for 'Summary', 'Account Information', 'Audit', and 'Utility'. Under 'Exceptions', it says 'No Exceptions to display'. The 'Reporting Status' section contains two tables. The first table, 'Credit Bureaus', shows account details for account 1600, including 'Last Reported' (7/18/17) and 'Next Update' (7/18/17). The second table, 'Debtor', shows 'Henry Shreim (PRIMARY)' with 'Credit Bureau Status' and 'Next Update Status'. At the bottom of the interface, there are buttons for 'Delete', 'Delete as Fraud', 'Delete as Paid by Insurance', and 'Evaluate Account'. A status bar at the very bottom displays database and login information.

3. Click **Delete as Paid by Insurance**.
4. In the confirmation dialog box, click **OK**. The system displays a message indicating that the account is deleted from reporting and adds an audit trail record. The system sends a delete request for the account in the next CBR file that your organization creates and excludes the account from subsequent credit reporting.

Note: If you remove the account from reporting and the account is not yet reported, you can undo the delete. For more information, see [Undo a Credit Reporting Delete Request](#).

Undo a Credit Reporting Delete Request

Use the **Summary** tab to undo the credit reporting delete request for the account, if you haven't sent the delete request to the credit bureaus. You can undo the following:

- Delete requests for accounts reported in error.
- Delete requests for customers who are a victim of fraud.
- Delete requests for accounts that insurance is paying or paid in full.

You must have the Allow Prevent Flag and Undo Delete Permission.

To undo a credit reporting delete request

1. In the **Reference Panel** navigation bar, click **Available Panels** and then click **CB Reporting**.
2. Click the **Summary** tab.

Available Panels ▾ CB Reporting ✕

View History Pending Record ▾ Help

Summary Account Information Audit Utility

Exceptions

- No Exceptions to display

Reporting Status

Credit Bureaus		Next Update	
Account	1840	Last Evaluated	7/18/17
Last Reported	1/14/17	Last Updated	6/2/17
Status:	<ul style="list-style-type: none"> I am the the Account Reported Message 	Status:	<ul style="list-style-type: none"> I am the Account Pending Message

Debtor	Credit Bureau Status	Next Update Status
Orlando Sloan (PRIMARY)	<ul style="list-style-type: none"> I am the Debtor Reported Message 	<ul style="list-style-type: none"> I am the Debtor Pending Message

Undo Prevent/Delete Evaluate Account

DB Server Name: localhost Database: Collect2000 Previous Login: Jun 2, 2017 2:48:11 pm Time on Account: 00:21:46

- Click **Undo Prevent/Delete**.
- In the confirmation dialog box, click **OK**. The system includes the account in subsequent credit reporting evaluations.

Credit Bureau Reporting Codes

Credit Bureau Reporting Codes

Latitude supports several credit bureau reporting codes. For more information, see the following:

- [Account Types](#)
- [Address Indicator](#)
- [CBR Account Status Codes](#)
- [Compliance Condition Codes](#)
- [Consumer Information Indicator \(Bankruptcy\) Codes](#)
- [Credit Bureau Reporting Exceptions](#)
- [Creditor Classification Code](#)
- [ECOA Codes](#)
- [Industry Codes](#)
- [Portfolio Types](#)
- [Residence Codes](#)
- [Special Comment Codes](#)

Latitude Printable Help

- [Supported Reporting Codes](#)
- [Transaction Types](#)

Account Types

The following table lists the account types that Latitude supports.

Code	Description
04	Home Improvement
05	Federal Housing Administration (FHA) Home Improvement Loan
0A	Time Share Loan
0C	Debt Purchaser
0F	Construction Loan
0G	Flexible Spending Credit Card
17	Manufactured Housing
18	Credit Card
2A	Secured Credit Card
37	Combined Credit Plan
48	Collection Agency/Attorney
6D	Home Equity
77	Returned Check
89	Home Equity Line of Credit
8A	Business Credit Card
9A	Secured Home Improvement

Address Indicator

The following table lists the address codes that Latitude supports.

Code	Description
[blank]	Address not available or unknown.
B	Business address - not consumer's residence.
C	Confirmed/Verified address Note: Use this code to report a confirmed or verified address after receiving an address discrepancy notification from a consumer reporting agency. Report this code one time after confirming the address.
D	Data reporter's default address.
M	Military address.
N	Not confirmed address.
P	Bill Payer Service - not consumer's residence.
S	Secondary address.
U	Non-deliverable address/Returned mail.
Y	Known to be address of consumer.

CBR Account Status Codes

The following table lists the CBR account status codes that Latitude supports.

Status Code	Description
05	Account transferred.
11	Current account (0-29 days past the due date). Installment and Mortgage loans require a current account with a non-zero balance amount. Credit Line, Open, and Revolving portfolio types require a current account that is available for use. For a closed account with a balance due, report Special Comment Code "M" or Compliance Condition Code "XA" to indicate that the account is no longer available for use.
13	Paid or closed account; zero balance. Installment and Mortgage loans require a paid account with a zero balance amount. Credit Line, Open, and Revolving portfolio types require an account that is no longer available for use and has a zero balance amount. Report Special Comment Code "M" or Compliance Condition Code "XA" to indicate a closed account.

Latitude Printable Help

62	Account paid in full; account was a collection account.
64	Account paid in full; account was a charge-off.
65	Account paid in full; foreclosure started.
71	Account 30-59 days past the due date.
78	Account 60-89 days past the due date.
80	Account 90-119 days past the due date.
82	Account 120-149 days past the due date.
83	Account 150-179 days past the due date.
84	Account 180 days or more past the due date.
89	Deed received in lieu of foreclosure on a defaulted mortgage.
93	Account assigned to internal or external collections.
94	Foreclosure completed; collateral sold to settle defaulted mortgage.
97	Unpaid balance reported as a loss (charge-off).
DA	<p>Delete entire account (for reasons other than fraud). For example:</p> <ul style="list-style-type: none"> • Account reported in error. • Consumer is deceased and no other associated party remains responsible for the account. • Insurance is paying the account, or paid the account in full. • Debt buyer forwarded or sold the account. • Third-party agency canceled and returned the account to the creditor. • Consumer has a discharged bankruptcy Chapter 7 or is in a Chapter 13 repayment plan currently. <p>Note: To maintain the integrity of credit information, don't request a subsequent deletion of account history unless reporting an actual error. Report paid derogatory accounts, such as collections, as paid; don't delete them.</p>
DF	Delete entire account because of confirmed fraud (fraud investigation completed).

Compliance Condition Codes

The following table lists the compliance condition codes that Latitude supports.

Code	Description
[blank]	Retains value reported previously or, no new Compliance Condition Code applies for this activity period.
XA	Account closed at consumer's request.
XB	Consumer disputed account information under the Fair Credit Reporting Act (FCRA). This code reports for as long as it is valid.
XC	Completed investigation of FCRA dispute; consumer disagrees.
XD	Account closed at consumer's request and in dispute under FCRA.
XE	Account closed at consumer's request and dispute investigation completed; consumer disagrees. Used for FCRA or FCBA disputes.
XF	Account in dispute under Fair Credit Billing Act (FCBA).
XG	FCBA dispute resolved; consumer disagrees.
XH	Account in dispute previously, now resolved and data furnisher reported. Used for FCRA or FCBA disputes.
XJ	Account closed at consumer's request and in dispute under FCBA.
XR	Removes the most recently reported compliance condition code. Note: Do not use "XR" as a default value. If no Compliance Condition Code applies in the current activity period, insert a [blank] code.

Consumer Information Indicator (Bankruptcy) Codes

The following table lists the Consumer Information Indicator (bankruptcy) codes that Latitude supports. Your organization can add other codes as needed. The system determines the code using the legal bankruptcy milestone dates specified for the account. The system uses a default code for accounts with a bankruptcy chapter but no legal milestone dates.

Code	Description
[blank]	Retains value reported previously, or no new Consumer Information Indicator applies for this activity period.

A	Petition for Chapter 7 bankruptcy.
B	Petition for Chapter 11 bankruptcy.
C	Petition for Chapter 12 bankruptcy.
D	Petition for Chapter 13 bankruptcy.
E	Discharged through Chapter 7 bankruptcy.
F	Discharged through Chapter 11 bankruptcy.
G	Discharged through Chapter 12 bankruptcy.
H	Discharged and completed through Chapter 13 bankruptcy. Report when consumer completes all payments through the Chapter 13 plan.
I	Chapter 7 bankruptcy dismissed.
J	Chapter 11 bankruptcy dismissed.
K	Chapter 12 bankruptcy dismissed.
L	Chapter 13 bankruptcy dismissed.
Q	Removes Bankruptcy Indicator (A through P, and Z) reported previously or Personal Receivership Indicator (1A). Also used to report bankruptcies that closed or terminated without being discharged or dismissed. Note: Don't report "Q" as a default value. Fill with a blank instead.
R	Reaffirmation of debt.
Z	Bankruptcy - Undesignated chapter.

Credit Bureau Reporting Exceptions

Exceptions prevent an account from reporting to the credit bureaus. More than one exception can exist simultaneously for the primary customer, responsible parties, and authorized parties. Account level errors that include the primary customer prevent the respective account from reporting. Errors at the responsible or authorized party level don't prevent the account from reporting but the system excludes them from reporting for the respective account. Accounts with exceptions don't report again until you correct the exceptions.

The following table lists the exceptions that prevent an account from reporting to the credit bureaus.

Exception	Description	Level	First-party	Third-party
Business	Account is for a business, not an individual.	Account	Yes	Yes
DebtorExcluded	User flagged the account for exclusion from reporting.	Customer	Yes	Yes
DebtorNotResponsible	User flagged a party on the account as not responsible for the debt. Party on the account is not a first-party authorized user.	Customer	Yes	Yes
DelinquencyDt>Received	Delinquency date is after the account received date.	Account	Yes	Yes
DelinquencyDtWithin30DaysOfReceived	Delinquency date is less than 30 days before the account received date.	Account	Yes	Yes
InvalidAcctType	Account type doesn't match the portfolio type and industry code. This issue is rare and indicates a configuration or data problem.	Account	Yes	Yes
InvalidConsumerAccountNumber	Consumer account number is missing.	Account	Yes	No
InvalidContractDate	Contract date is missing.	Account	Yes	No
InvalidContractToPay	Contract date is missing and the creditor class is not medical.	Account	Yes	Yes
InvalidDebtorZipcode	Customer's ZIP Code is invalid. *	Customer	Yes	Yes
InvalidDOB	Authorized user's date of birth is missing or a responsible party's SSN and date of birth are both missing. If the account reported previously, the date of birth constraint doesn't apply for authorized users. *	Customer	Yes	Yes
InvalidFirstName	Customer's last name is missing or invalid. *	Customer	Yes	Yes

Latitude Printable Help

InvalidLastName	Customer's last name is missing or invalid. *	Customer	Yes	Yes
InvalidOriginalLoanAmount	Original loan amount is missing.	Account	Yes	Yes
InvalidState	Customer's state (in address) is invalid. *	Customer	Yes	Yes
MedicalWithin180Days	Account has a medical creditor classification and is less than 180 days past the delinquency date.	Account	Yes	Yes
MinBalException	Current account balance is less than the configured minimum amount.	Account	Yes	Yes
MissingAcctOriginalCreditor	Original creditor is missing and there isn't a default original creditor provided.	Account	Yes	Yes
MissingChargeOffAmount	Charge-off amount is missing.	Account	Yes	No
MissingChargeOffRecord	Required charge-off information is missing.	Account	Yes	No
MissingCity	Customer's city (in address) is missing. *	Customer	Yes	Yes
MissingCreditorClass	Creditor classification is missing.	Account	Yes	Yes
MissingDefaultOriginalCreditor	Default original creditor is missing.	Account	Yes	Yes
MissingSecondaryAccountNumber	Secondary account number is missing and the debt is charge-off mortgage.	Account	Yes	No
MissingSecondaryAgencyIdentifier	Secondary agency identifier is missing and the debt is charge-off mortgage.	Account	Yes	No
MissingSSN&DOB	Customer's SSN or date of birth is missing. *	Customer	Yes	Yes
MissingStreetAddress	Customer's street address line 1 is missing. *	Customer	Yes	Yes
NullDebtorZipcode	Customer's ZIP Code is missing. *	Customer	Yes	Yes
NullDelinquencyDt	Delinquency date is missing.	Account	Yes	Yes

OpenChargeOffNotInBankruptcy	Charge-off account has an open status and isn't in bankruptcy.	Account	Yes	No
OutofStatute	Federal 7-year reporting statute expired.	Account	Yes	Yes
ReportDateNotMet	Account has a reporting wait time set that is not expired.	Account	Yes	Yes
ZeroedDebtorZipcode	Customer's ZIP Code contains all zeroes. *	Customer	Yes	Yes

* Applies to reported accounts with an open date after September 15, 2017.

Creditor Classification Code

The following table lists the creditor classification codes that Latitude by Genesys supports.

Code	Description
01	Retail
02	Medical/Health Care
03	Oil Company
04	Government
05	Personal Services
06	Insurance
07	Educational
08	Banking
09	Rental/Leasing
10	Utilities
11	Cable/Cellular
12	Financial
13	Credit Union

Latitude Printable Help

14	Automotive
15	Check Guarantee

ECOA Codes

The following table lists the Equal Credit Opportunity Act (ECOA) codes that Latitude by Genesys supports.

Code	Description
1	Individual: Party has contractual responsibility for the account and has primary responsibility for its payment.
2	Joint Contractual Liability: Party signed an agreement to repay all debts arising on the account. There are other parties associated to the account who could have contractual responsibility.
3	Authorized User: Party is an authorized user of the account; another party has contractual responsibility.
5	Co-maker or Guarantor: Party guaranteed the account and assumes responsibility for the account if the maker defaults.
7	Maker: Party is responsible for the account; a cosigner guaranteed the account.
T	Terminated: Party is no longer associated to the account; do not report.
W	Business/Commercial: Account is for a company.
X	Deceased: Party is deceased. There could be other parties associated to the account.
Z	Delete: Party reported in error; delete the party from the reporting file.

Industry Codes

The following table lists the industry codes that Latitude by Genesys supports.

Code	Description
CC	Credit Card
DEBTCOLL	Debt Collection
MORTGAGE	Mortgage

Portfolio Types

The following table lists the portfolio types that Latitude by Genesys supports.

Code	Description
C	Line of credit
I	Installment
O	Open Account
R	Revolving

Residence Codes

The following table lists the residence codes that Latitude by Genesys supports.

Code	Description
[blank]	Not available or unknown.
O	Consumer owns the residence associated to the reported address.
R	Consumer rents the residence associated to the reported address.

Special Comment Codes

The following table lists the special comment codes that Latitude by Genesys supports.

Code	Description
AB	Debt paid through insurance. Account status code cannot be "13", "61", "62", "63", "64", or "65".
AC	Paying under a partial payment agreement. Account status code cannot be "13", "61", "62", "63", "64", or "65".
AG	Simple interest loan. Any loan where interest compounds daily.
AH	Purchased by another company.
AI	Recalled to active military duty.
AJ	Payroll deduction.
AM	Account payments assured through wage garnishment.

Latitude Printable Help

AN	Account acquired by Federal Deposit Insurance Corporation (FDIC) or National Credit Union Administration (NCUA).
AP	Credit Line suspended. The credit line is temporarily unavailable for use.
AS	Account closed because of refinance.
AT	Account closed because of transfer. Used for internal transfers.
AU	Account paid in full for less than the full balance. Requires account status code "13", "61", "62", "63", "64", or "65" and a current balance of 0.
AV	First payment never received; could indicate fraudulent activity.
AW	Affected by natural or declared disaster.
AX	Account paid from collateral. Requires account status code "13", "61", "62", "63", "64", or "65" and a current balance of 0.
B	Financial counseling program manages the account payments.
BA	Transferred to Recovery. Requires account status code "71", "78", "80", "82", "83", "84", "88", "89", "93", "94", "95", "96", or "97".
BL	Credit card lost or stolen.
BN	Company that originally sold the merchandise paid. Requires account status code "13", "61", "62", "63", "64", or "65" and a current balance of 0.
BP	Paid through insurance. Requires account status code "13", "61", "62", "63", "64", or "65" and a current balance of 0.
BT	Principal deferred; interest payment only.
C	Co-maker or Guarantor pays. Requires account status code "13", "61", "62", "63", "64", or "65" and a current balance of 0.
CH	Guaranteed, insured.
CJ	Credit line no longer available; in repayment phase. Account status code cannot be "13", "61", "62", "63", "64", or "65" and the current balance cannot be 0. Use for line of credit accounts that have two phases: the borrowing phase and the repayment phase. The repayment phase is a natural progression for the account when the consumer is responsible for payment of the outstanding balance and the credit line is no longer available for use.

CK	Credit line reduced because of collateral depreciation. Use for home equity or other secured line of credit accounts.
CM	Creditor released the collateral; balance owing. Account status code cannot be "13", "61", "62", "63", "64", or "65" and the current balance cannot be 0. Use for mortgages, home equity, or other secured accounts when the creditor releases the collateral but the consumer still has an outstanding balance to repay.
CN	Loan modified under a federal government plan.
CO	Loan modified, but not under a federal government plan.
H	Another party assumed the loan. Requires ECOA Code "T" (Terminated).
M	Account closed at credit grantor's request.
O	Account transferred to another lender.
S	Special handling. Contact credit grantor for more information.
V	Adjustment pending. Account adjustment, such as returned merchandise or refund due.

Supported Reporting Codes

The following table lists the reporting codes that Latitude by Genesys supports by [industry](#) and [portfolio type](#).

Industry Code	Portfolio Types	Account Types	CBR Account Status Codes	Compliance Condition Codes	Special Comment Codes	ECOA Codes
CC	O	18	05	[blank]	AB	1
		2A	11	XA	AC	2
		37	13	XB	AH	3
		8A	64	XC	AI	5
			71	XD	AJ	7
			78	XE	AM	T
			80	XF	AN	W
			82	XG	AP	X
			83	XH	AT	Z
			84	XJ	AU	

Latitude Printable Help

			97 DA DF	XR	AV AW B BA BL BP C CH CN CO M O S V	
CC	R	OG 18 2A 37 8A	05 11 13 64 71 78 80 82 83 84 97 DA DF	[blank] XA XB XC XD XE XF XG XH XJ XR	AB AC AH AI AJ AM AN AP AT AU AV AW AX B BA BL BP	1 2 3 5 7 T W X Z

Reference Panels

					C CH CM CN CO M O S V	
DEBTCOLL	O	OC 48 77	62 93 DA DF	XB XC XF XG XH XR	AB AC AI AJ AM AU AW B BP C S V	1 2 3 5 7 T W X Z
MORTGAGE	C	89	05 11 13 64 65 71 78 80 82	XA XB XC XD XE XF XG XH XJ	AB AC AH AI AJ AM AN AP AS	1 2 3 5 7 T W X Z

Latitude Printable Help

			83	XR	AT	
			84		AU	
			89		AV	
			94		AW	
			97		B	
			DA		BA	
			DF		BP	
					C	
					CH	
					CJ	
					CK	
					CM	
					CN	
					CO	
					M	
					O	
					S	
					V	
MORTGAGE	I	04	05	XB	AB	1
		05	11	XC	AC	2
		0A	13	XF	AG	3
		0F	64	XG	AH	5
		17	65	XH	AI	7
		6D	71	XR	AJ	T
		9A	78		AM	W
			80		AN	X
			82		AS	Z
			83		AT	
			84		AU	
			89		AV	
			94		AW	

			97		AX	
			DA		B	
			DF		BA	
					BN	
					BP	
					BT	
					C	
					CH	
					CM	
					CN	
					CO	
					H	
					O	
					S	
					V	

Transaction Types

The following table lists the transaction types that Latitude by Genesys supports.

Code	Description
[blank]	Account or borrower is not new, or no change in consumer information.
1	Newly opened account, or new borrower associated to existing account.
2	Name change.
3	Address change.
5	Social Security Number change.
6	Name and address change.
8	Name and Social Security Number change.
9	Address and Social Security Number change.
A	Name, Address, and/or Social Security Number change.

Custom Panel

Custom Panel

Use custom panels to view information that your organization specifies. For each panel, your organization specifies a panel name, the data to display, and whether users can view the panel.

Create a Custom Panel

Administrators can create a custom panel to display read-only data for the account. An administrator specifies a name for the panel, the data to display, and whether users can view the panel.

Administrators can create as many custom panels as necessary.

To create a custom panel

1. Create a stored procedure that takes in the @accountid parameter as an INT and specifies the data to display in the panel. The @accountid parameter is the file number. The following example shows a procedure that pulls data from the lat.Note table:

```
CREATE PROCEDURE dbo.TestNotes
(
    @accountid INT
)
AS
BEGIN

    SELECT [UserName], [ActionCode], [ResultCode], [Comment], [DateCreated]
    FROM [lat].[Note]
    WHERE [AccountId] = @accountid
    ORDER BY [DateCreated] DESC

END

GO
```

2. Insert a row into the lat.UserInterfacePlugins table that specifies the plug-in name, display name (panel name), and Sproc name. Don't change the "type" or "URL" values. See the following example:

```
INSERT INTO [lat].[UserInterfacePlugins]
( [Type] ,
  [PluginName] ,
```

```

[DisplayName] ,
[Url] ,
[Parameters]
)
VALUES ( 'PANEL' , -- Type - varchar(25)
'GenericDataPanel' , -- PluginName - varchar(50)
N'Generic Data Grid Panel' , -- DisplayName - nvarchar(100)
N'workform/views/panel/genericPanel.tmpl.html' , -- Url - nvarchar(250)
'dbo.TestNotes' -- Parameters - varchar(255)
)

```

3. Enable the panel in the Reference Panels permission. When a user with the appropriate permissions opens the panel, Latitude calls the associated procedure, passes the file number, and displays the returned data in the associated panel.

UserName	ActionCode	ResultCode	Comment	DateCreated
FUSION	SEND	SEND	Equifax FirstSearch Service data ordered on 04/27/2012. Current Balance = 1307.21	2012-04-27
EXCHANGE-S	CO	CO	NEW BIZ IMPORT	2011-02-11

View a Custom Panel

Use a custom panel to view information that your organization configured to display for the account. You can filter the data and also export the data to a Comma Separated Value (CSV) file. You must have the Reference Panels Permission to view the custom panel.

To view a custom panel

1. In the **Reference Panel** navigation bar, click **Available Panels** and then click the name of the custom panel. The following is an example of a custom panel.

UserName	ActionCode	ResultCode	Comment	DateCreated
FUSION	SEND	SEND	Equifax FirstSearch Service data ordered on 04/27/2012. Current Balance = 1307.21	2012-04-27
EXCHANGE-S	CO	CO	NEW BIZ IMPORT	2011-02-11

2. To display only the rows with data that meet specific criteria, in the **Filter page by** box, type a word or phrase. Only rows with data that match the specified criteria display in the data grid.

3. To export all the unfiltered data to a CSV file, click **Export All To CSV**. The system downloads all data to a CSV file. If you have Microsoft Excel, the system defaults to opening the file in Microsoft Excel.

Tip: To clear a filter, delete the content in the **Filter page by** box.

Documentation

Documentation

Use the **Documentation** panel to attach electronic documents to the account. You can also view, download, and detach documents. You must have the appropriate permissions to attach, view, and detach documents.

Attach a Document to an Account

Use the **Documentation** panel to attach an electronic document to the account. Latitude supports any document type, such as a Word document, Excel file, text file, or image. You must have the Attach Documentation Permission.

To attach a document to an account

1. In the **Reference Panel** navigation bar, click **Available Panels** and then click **Documentation**.

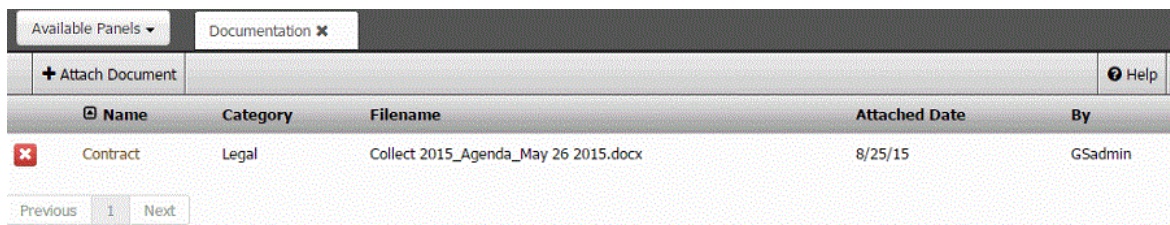

2. In the **Documentation** toolbar, click **Attach Document**.

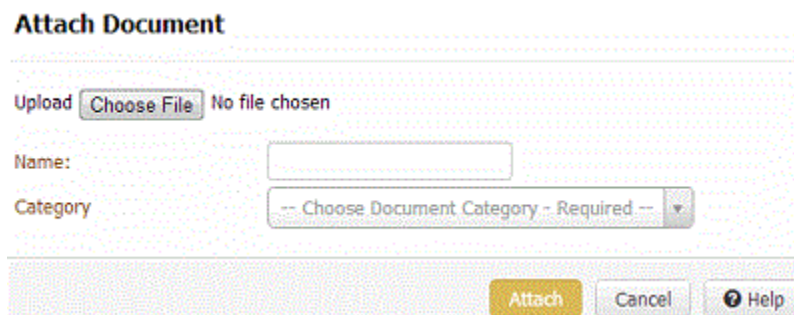

3. Do one of the following, depending on what your Internet browser allows:
 - Click **Choose File**. In the **Open** dialog box, locate the file to attach, click it, and then click **Open**.
 - Drag and drop a file onto **Choose File**.
4. In the **Name** box, type a name for the document.
5. In the **Category** list box, click the category to assign to the document.

- Click **Attach**.

View Documents Attached to an Account

Use the **Documentation** panel to view a list of documents that are attached to the account. You can also select a document and view it. You must have the View Attached Documents Permission.

To view documents attached to an account

- In the **Reference Panel** navigation bar, click **Available Panels** and then click **Documentation**.

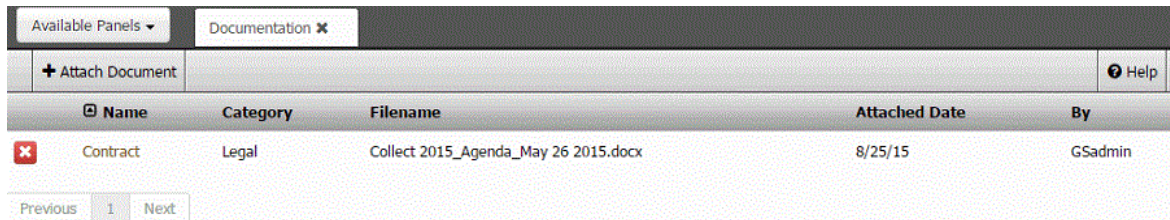

Available Panels ▾		Documentation ✕			
+ Attach Document					Help
Name	Category	Filename	Attached Date	By	
✕ Contract	Legal	Collect 2015_Agenda_May 26 2015.docx	8/25/15	GSAdmin	

Previous 1 Next

- To view a document, in the **Name** column, click the link. The document appears minimized beneath the status bar. Click the document to open it in the associated program (for example, Word, Excel).

Download a Document

Use the **Documentation** panel to download a document that is attached to the account.

To download a document

- In the **Reference Panel** navigation bar, click **Available Panels** and then click **Documentation**.

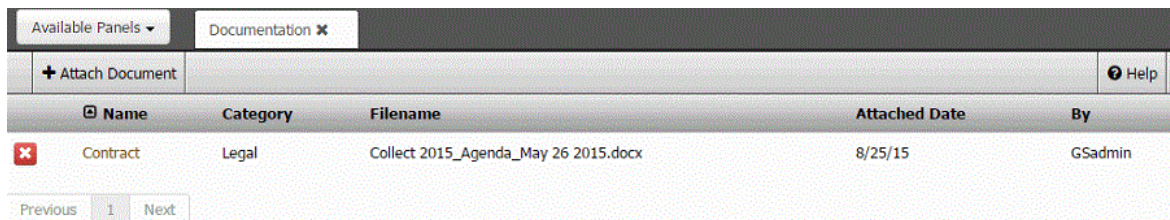

Available Panels ▾		Documentation ✕			
+ Attach Document					Help
Name	Category	Filename	Attached Date	By	
✕ Contract	Legal	Collect 2015_Agenda_May 26 2015.docx	8/25/15	GSAdmin	

Previous 1 Next

- Do one of the following, depending on what your Internet browser allows:
 - In the **Name** column, right-click the link and then click **Save Target as...** Specify a location and file name and then click **Save**.
 - In the **Name** column, click the link. The document appears under the status bar. Click the document to open it in its associated program and then save the file.

Delete a Document From an Account

Use the **Documentation** panel to delete a document from the account. You must have the Delete Documentation Permission.

To delete a document from an account

- In the **Reference Panel** navigation bar, click **Available Panels** and then click **Documentation**.

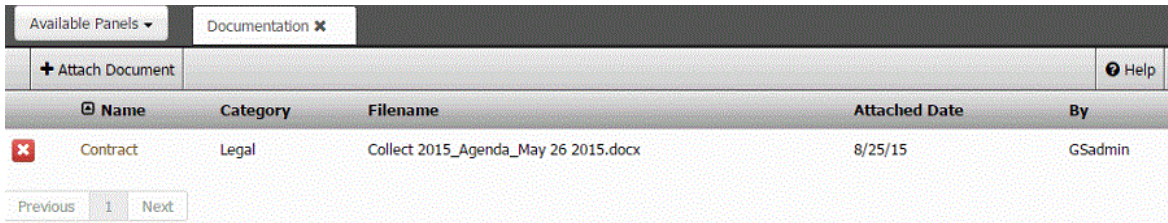

2. Click the Delete icon and then click **OK**.
3. In the confirmation dialog box, click **OK**.

Email Addresses

Email Addresses

Use the **Email** panel to view, add, and modify email addresses associated to the account. You can also indicate whether the contact person granted permission to send email messages to specific email addresses.

View Email Addresses

Use the **Email** panel to view email addresses associated to the account.

To view email addresses

1. In the **Reference Panel** navigation bar, click **Available Panels** and then click **Email**.

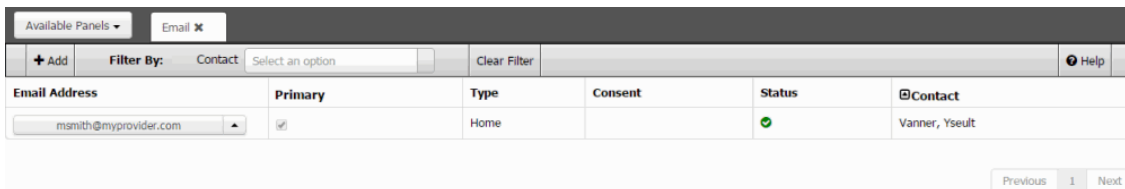

Email Address: Person's email address.

Primary: If selected, the email address is the person's primary (main) email address.

Type: Type of email, such as home or work.

Consent: Indicates whether the person granted permission to send email messages to the email address.

Status: Status of the email address, such as good, bad, or unknown.

Contact: Name of the person associated to the email address.

2. To display email addresses for a specific person only, in the **Contact** box in the **Email** toolbar, click the name of the person. Only the email addresses for the specified person appear in the panel.

Tip: To clear the filter and display all email addresses, click **Clear Filters**.

Add an Email Address

Use the **Add Email Address** dialog box to add an email address to the account.

To add an email address

1. In the **Reference Panel** navigation bar, click **Available Panels** and then click **Email**.

Email Address	Primary	Type	Consent	Status	Contact
msmith@myprovider.com	<input checked="" type="checkbox"/>	Home		Good	Vanner, Yseult

2. In the **Email** toolbar, click **Add**.

Add Email Address

Email Address *
 Type *
 Status *
 Customer on Account *
 Is Primary?
 Consent To Email Granted
 Obtained From *
 Method Written Verbal
 Comment

Email Address: Person's email address (for example, jdoe@myprovider.com).

Type: Type of email address, such as home or work.

Status: Status of the email address, such as good, bad, or unknown.

Customer on Account: Person associated to the email address.

Is Primary: If selected, the email address is the person's primary (main) email address.

Consent To Email: If selected, the person granted permission to send email messages to this email address. If cleared, the person denied permission to send email messages to this email address.

Obtained From: Name of the person who granted or denied permission to send email messages to this email address.

Method: Indicates whether the person granted permission verbally or in writing.

Comment: More information regarding the email address.

3. Complete the information and then click **Save**.

Modify an Email Address

Use the **Edit Email Address** dialog box to modify an email address for the account. You can also modify permissions for sending email messages to an email address.

To modify an email address

1. In the **Reference Panel** navigation bar, click **Available Panels** and then click **Address**.

Available Panels					
Email ✕					
+ Add	Filter By:	Contact	Select an option	Clear Filter	Help
Email Address	Primary	Type	Consent	Status	Contact
msmith@myprovider.com	<input checked="" type="checkbox"/>	Home		<input checked="" type="checkbox"/>	Vanner, Yseult

Previous 1 Next

2. In the data grid, click the email address and then, in the **Email Address** list box, click **Edit**.

Edit Email Address

Email Address Eva.Severino@mail.com

Type

Status

Customer on Account

Is Primary?

Consent To Email **Granted**

Obtained From

Method **Written** **Verbal**

Comment

Save **Cancel** **Help**

Email Address: Person's email address (for example, jdoe@myprovider.com).

Type: Type of email address, such as home or work.

Status: Status of the email address, such as good, bad, or unknown.

Customer on Account: Person associated to the email address.

Is Primary: If selected, the email address is the person's primary (main) email address.

Consent To Email: If selected, the person granted permission to send email messages to this email address. If cleared, the person denied permission to send email messages to this email address.

Obtained From: Name of the person who granted or denied permission to send email messages to this email address.

Method: Indicates whether the person granted permission verbally or in writing.

Comment: More information regarding the email address.

3. Modify the information and then click **Save**.

Change the Status of an Email Address

Use the **Email** panel to change the status of an email address for the account.

To change the status of an email address

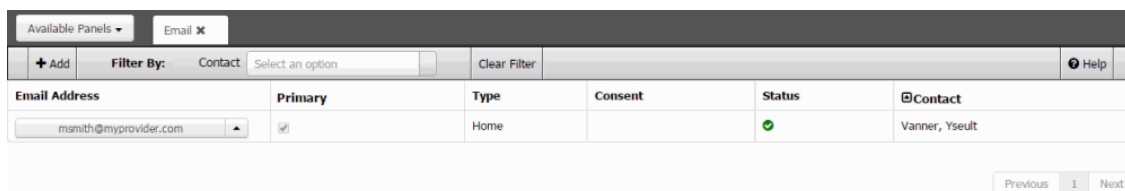

1. In the **Reference Panel** navigation bar, click **Available Panels** and then click **Email**.



2. In the data grid, click the email address and then, in the **Email Address** list box, do one of the following:
 - If the email address is good, click **Good**.
 - If the email address is bad, click **Bad**.
 - If the email address is unknown, click **Unknown**.



Email Consent Icons

The following table lists the email consent icons and their description.

Icon	Description
	Person granted permission to send messages to this email address.
	Person denied permission to send messages to this email address.

Email Status Icons

The following table lists the email status icons and their description.

Icon	Description
	Email address is good.
	Email address is bad.

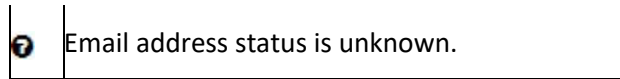

Extra Data

Extra Data

Use the **Extra Data** panel to view, add, and modify custom data for the account.

Add Extra Data

Use the **Extra Data** panel to add custom data to the account. You must have the Create Extra Data Permission.

To add extra data

1. In the **Reference Panel** navigation bar, click **Available Panels** and then click **Extra Data**.

A screenshot of the software interface for adding extra data. At the top, there is a navigation bar with "Available Panels" and "Extra Data" tabs. Below this is a header area with an "Add" button and a "Help" icon. The main content area features a dropdown menu labeled "Select an option" on the left and five empty input boxes on the right, arranged vertically. At the bottom of the form is a yellow "Save" button.

2. In the extra data code list box, click the code to add. Boxes appear for the selected code.
3. Complete the information for each box and then click **Save**. A new tab for the specified extra data code appears on the **Extra Data** panel.

Modify Extra Data

Use the **Extra Data** panel to modify extra data associated to the account. A tab appears on the **Extra Data** panel for each extra data code associated to the account. You must have the Update Extra Data Permission.

To modify extra data

1. In the **Reference Panel** navigation bar, click **Available Panels** and then click **Extra Data**.
2. Click the tab for the extra data to modify.

Available Panels ▾ Extra Data ✕

Help

Add LL

LANDLORD

NAME

ADDR1

CSZ

PHONE

LEASE #

Save

3. Modify the information and then click **Save**.

Fusion Service History

Fusion Service History

Use the **Fusion Service History** panel to view service requests for all parties on the account and the responses received from outside service providers. For example, your organization can request an address verification from an outside service. Users generate these requests and receive the responses using Fusion. For more information, see the *Fusion* documentation.

View Fusion Service History

Use the **Fusion Service History** panel to view service requests for all parties on the account and the responses received from outside service providers.

To view Fusion service history

1. In the **Reference Panel** navigation bar, click **Available Panels** and then click **Fusion Service History**. The navigation tree is sorted by party name, service provider, and service request date and time.

Available Panels ▾ Notes ✕ Fusion Service History ✕

Help

WIESEN, ROY

null

12/31/0000 07:00 pm

Requesting Application:

Requested By:

Verified By:

Verified Date:

Verified

[Name]: Name of the party on the account for whom a user requested the service.

[Provider]: Name of the service provider.

[Date]: Date and time a user requested the service.

2. In the navigation tree, expand the party name and service provider nodes.
3. Click the date and time entry. The service history appears. If the system received a response from the service provide, it appears also.

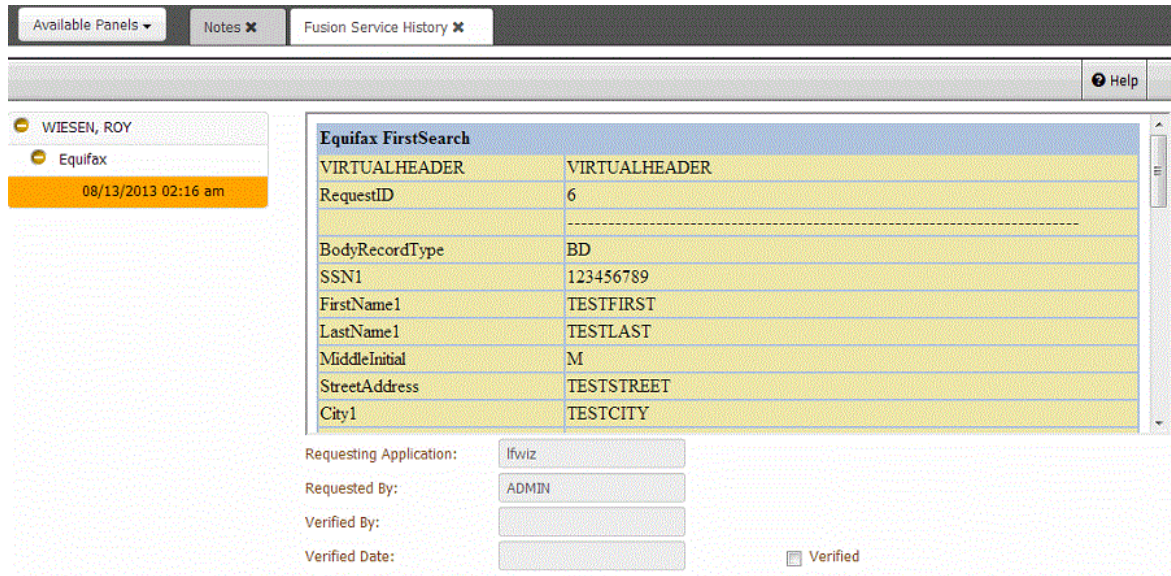

[Data]: Data submitted with the service request to the outside service provider.

Requesting Application: Program that requested the service.

Requested by: User who requested the service.

Verified by: User who verified the response from the service provider.

Verified Date: Date a user verified the response.

Verified: If selected, a user verified the response.

Verify a Response From an Outside Service Provider

Use the **Fusion Service History** panel to verify a response from an outside service provider for the account. You must have the Fusion Services - Verify Responses Permission.

To verify a response from an outside service provider

1. In the **Reference Panel** navigation bar, click **Available Panels** and then click **Fusion Service History**.

Available Panels ▾ Notes ✕ Fusion Service History ✕

WIESEN, ROY
null
12/31/0000 07:00 pm

Requesting Application:
Requested By:
Verified By:
Verified Date: Verified

- In the navigation tree, expand the party name and service provider nodes.
- Click the date and time entry. The service history appears.
- Select the **Verified** check box. The system populates the **Verified By** box with your user name and populates the **Verified Date** box with the current date and time.

Available Panels ▾ Notes ✕ Fusion Service History ✕

WIESEN, ROY
Equifax
08/13/2013 02:16 am

Equifax FirstSearch	
VIRTUALHEADER	VIRTUALHEADER
RequestID	6
BodyRecordType	BD
SSN1	123456789
FirstName1	TESTFIRST
LastName1	TESTLAST
MiddleInitial	M
StreetAddress	TESTSTREET
City1	TESTCITY

Requesting Application:
Requested By:
Verified By:
Verified Date: Verified

Income and Expenditures

Income and Expenditures

Use the **Income and Expenditure** panel to maintain a customer's income and expenditures. Latitude uses this information to calculate the customer's monthly disposable income. This information assists you in arranging a successful payment plan with the customer. You must have the Maintain Income and Expense items Permission.

For a linked account, this panel depends on the account having a Personal Unique Record Number (PURN) value. The system only allows one active income and expense record for an individual PURN. If a PURN is associated to more than one account, Latitude displays the income and expense record for the PURN regardless of which account you are viewing. You can update income and expenses from any of the linked accounts.

Add Financial Summary Information

Use the **Summary** tab in the **Income and Expenditure** dialog box to add financial summary information to the account.

To add financial summary information

1. In the **Reference Panel** navigation bar, click **Available Panels** and then click **Income and Expenditure**.

2. In the **Income and Expenditure** toolbar, click **Add** and then, in the **Income and Expenditure** dialog box, click the **Summary** tab.

Employment Status: Customer's employment status.

Home Status: Customer's home ownership or living situation.

Adults: Number of household members who are over the age of 18.

Children Under 14: Number of household members who are under the age of 14.

Children 14-18: Number of household members who are 14-18 years of age.

Vehicles: Number of vehicles in use for the household.

Total Income: Total amount of income from the **Income** tab. Latitude populates this box.

Total Expenditure: Total amount of expenses from the **Expense** tab. Latitude populates this box.

Total Priority Debt: Total amount of priority debt from the **Arrears** tab. Latitude populates this box.

Total Other Debt: Total amount of other debt from the **Arrears** tab. Latitude populates this box.

Disposable Income: Amount of monthly disposable income. Latitude calculates this value using the following formula: Total Income - (Total Expenses + Total Priority Debt + Total Other Debt).

3. Complete the information and then click **Save**.

Add Income

Use the **Income** tab to add income for the account.

To add income

1. In the **Reference Panel** navigation bar, click **Available Panels** and then click **Income and Expenditure**.

The screenshot shows the top navigation bar of the system. It includes a dropdown menu for 'Available Panels', a 'Notes' button, and a selected 'Income And Expenditure' button. Below this is a toolbar with an '+Add' button, 'History', and 'Help' icons. A secondary navigation bar contains tabs for 'Summary', 'Income', 'Expenses', and 'Arrears', with 'Income' currently selected.

Status		Monthly Financials	
Employment Status	<input type="text"/>	Total Income	<input type="text" value="£ 0"/>
Home Status	<input type="text"/>	Total Expenditure	<input type="text" value="£ 0"/>
Household		Total Priority Debt	<input type="text" value="£ 0"/>
Adults	<input type="text" value="0"/>	Total Other Debt	<input type="text" value="£ 0"/>
Children Under 14	<input type="text" value="0"/>	Disposable Income	<input type="text" value="£ 0"/>
Children 14-18	<input type="text" value="0"/>	Date Of Next Review	<input type="text"/>
Vehicles	<input type="text" value="0"/>		

2. In the **Income and Expenditure** toolbar, click **Add** and then click the **Income** tab.

Income and Expenditure

The screenshot shows the 'Income and Expenditure' form. The top navigation bar has tabs for 'Summary', 'Income', 'Expenses', and 'Arrears', with 'Income' selected. The form is divided into two main sections: 'Income' and 'Property and Assets'. The 'Income' section includes fields for Salary, Benefits, Allowances, Other, and Total Income, each with a currency input and a frequency dropdown. The 'Property and Assets' section includes fields for Value of Property, Mortgage Outstanding, Secured Loans, and Other Assets, each with a currency input. At the bottom, there are 'Save' and 'Cancel' buttons.

Income		Property and Assets	
Salary	<input type="text" value="£ 0"/> <input type="text" value="Monthly"/>	Value of Property	<input type="text" value="£ 0"/>
Benefits	<input type="text" value="£ 0"/> <input type="text" value="Monthly"/>	Mortgage Outstanding	<input type="text" value="£ 0"/>
Allowances	<input type="text" value="£ 0"/> <input type="text" value="Monthly"/>	Secured Loans	<input type="text" value="£ 0"/>
Other	<input type="text" value="£ 0"/> <input type="text" value="Monthly"/>	Other Assets	<input type="text" value="£ 0"/>
Total Income	<input type="text" value="£ 0"/>		

Income

Salary: Amount of money the customer receives from salary, and the frequency received.

Benefits: Amount of money the customer receives from benefits, and the frequency received.

Allowances: Amount of money the customer receives from allowances, and the frequency received.

Other: Amount of money the customer receives from other sources, and the frequency received.

Total Income: Total income that the customer receives.

Property and Assets - The system doesn't include these amounts in calculations.

Value of Property: Monetary value of the customer's property.

Mortgage Outstanding: Amount of the customer's mortgage that is outstanding.

Secured Loans: Balance of the customer's secured loans.

Other Assets: Monetary value of the customer's other assets.

3. Complete the information and then click **Save**.

Add Expenses

Use the **Expenses** tab to add expenses for the account. The **Trigger Figures** section displays the average expense amounts based on the number of people in the household and their ages. You must have the Trigger Values Permission to modify these amounts.

To add expenses

1. In the **Reference Panel** navigation bar, click **Available Panels** and then click **Income and Expenditure**.

The screenshot shows the 'Income and Expenditure' tool interface. At the top, there is a navigation bar with 'Available Panels', 'Notes', and 'Income And Expenditure'. Below this is a toolbar with a '+Add' button and 'History' and 'Help' icons. A secondary toolbar contains tabs for 'Summary', 'Income', 'Expenses', and 'Arrears'. The main area is split into two columns. The left column has a 'Status' section with dropdowns for 'Employment Status' and 'Home Status', and a 'Household' section with input fields for 'Adults', 'Children Under 14', 'Children 14-18', and 'Vehicles', all containing the number '0'. The right column has a 'Monthly Financials' section with input fields for 'Total Income', 'Total Expenditure', 'Total Priority Debt', 'Total Other Debt', and 'Disposable Income', all containing '£ 0', and a 'Date Of Next Review' field.

2. In the **Income and Expenditure** toolbar, click **Add** and then click the **Expenses** tab.

Income and Expenditure

Summary	Income	Expenses	Arrears
Mortgage	£ 0	Monthly	Vehicle
Rent	£ 0	Monthly	Car Tax/Insurance/Fuel
Council Tax	£ 0	Monthly	Other Travel
Utilities	£ 0	Monthly	e.g. Public Transport
Water/Gas/Electricity	£ 0	Monthly	Food
Telephone	£ 0	Monthly	Clothing
Landline/Mobile/Broadband	£ 0	Monthly	Other Housekeeping
Television	£ 0	Monthly	Lottery/Tobacco/Social/Healthcare
TV License/Satellite TV	£ 0	Monthly	Other
Trigger Figures			
Phone:	£100.00	Travel:	£150.00
		Housekeeping:	£250.00
		Other:	£300.00
<input type="button" value="Save"/> <input type="button" value="Cancel"/>			

Mortgage: Mortgage expense and the frequency in which the customer incurs this expense.

Rent: Rent expense and the frequency in which the customer incurs this expense.

Council Tax: Council tax expense and the frequency in which the customer incurs this expense.

Utilities: Utilities expenses (including water, gas, and electricity) and the frequency in which the customer incurs this expense.

Telephone: Telephone expenses (including land line, mobile, and broadband) and the frequency in which the customer incurs this expense.

Television: Television expenses (including TV license and satellite TV) and the frequency in which the customer incurs this expense.

Vehicle: Vehicle expenses (including car tax, insurance, and fuel) and the frequency in which the customer incurs this expense.

Other Travel: Other travel expenses (such as public transportation) and the frequency in which the customer incurs this expense.

Food: Food expense and the frequency in which the customer incurs this expense.

Clothing: Clothing expenses and the frequency in which the customer incurs this expense.

Other Housekeeping: Other housekeeping expenses and the frequency in which the customer incurs this expense.

Other: Other expenses and the frequency in which the customer incurs this expense.

Trigger Figures - Trigger figures with a red background indicate that the actual expense exceeds the trigger value.

Phone: Maximum amount that your organization considers normal for telephone expenses.

Travel: Maximum amount that your organization considers normal for travel expenses. Travel expenses include car tax, insurance, fuel, and other travel expenses such as public transport.

Housekeeping: Maximum amount that your organization considers normal for housekeeping expenses. Housekeeping expenses include food, clothing, lottery, tobacco, social, and healthcare.

Other: Maximum amount that your organization considers normal for other expenses.

- 1.
3. Complete the information and then click **Save**.

Add Arrears

Use the **Arrears** tab to add past due debt for the account.

To add arrears

1. In the **Reference Panel** navigation bar, click **Available Panels** and then click **Income and Expenditure**.

The screenshot shows the 'Income and Expenditure' form interface. At the top, there is a navigation bar with 'Available Panels' (dropdown), 'Notes' (with an 'x' icon), and 'Income And Expenditure' (with an 'x' icon). Below this is a toolbar with '+Add', 'History' (with a document icon), and 'Help' (with a question mark icon). The main content area has a tabbed interface with 'Summary', 'Income', 'Expenses', and 'Arrears' tabs. The 'Summary' tab is active, showing two columns: 'Status' and 'Household' on the left, and 'Monthly Financials' on the right. The 'Status' section includes 'Employment Status' and 'Home Status', both with dropdown menus. The 'Household' section includes 'Adults', 'Children Under 14', 'Children 14-18', and 'Vehicles', each with a text input field containing '0'. The 'Monthly Financials' section includes 'Total Income', 'Total Expenditure', 'Total Priority Debt', 'Total Other Debt', 'Disposable Income', and 'Date Of Next Review', each with a text input field. The monetary fields are pre-filled with '£ 0'.

2. In the **Income and Expenditure** toolbar, click **Add** and then click the **Arrears** tab.

Income and Expenditure

Summary	Income	Expenses	Arrears
Monthly Priority Debts			
Mortgage Arrears		£	<input type="text" value="0"/>
Rent Arrears		£	<input type="text" value="0"/>
Council Tax Arrears		£	<input type="text" value="0"/>
Utilities Arrears		£	<input type="text" value="0"/>
Other Secured Loans		£	<input type="text" value="0"/>
Magistrates Fines		£	<input type="text" value="0"/>
Maintenance		£	<input type="text" value="0"/>
Hire Purchase		£	<input type="text" value="0"/>
Other Arrears		£	<input type="text" value="0"/>
Monthly Other Debts			
Total No of Credit/Store Cards			<input type="text" value="0"/>
Credit/Store Cards Balance		£	<input type="text" value="0"/>
Credit/Store Cards Monthly Payment		£	<input type="text" value="0"/>
Total No of Loan Agreements			<input type="text" value="0"/>
Loan Agreements Balance		£	<input type="text" value="0"/>
Loan Agreements Monthly Payments		£	<input type="text" value="0"/>
Other Debts Balance		£	<input type="text" value="0"/>
Other Debts Monthly Payments Include Bank Overdraft		£	<input type="text" value="0"/>
<input type="button" value="Save"/> <input type="button" value="Cancel"/>			

Mortgage Arrears: Overdue mortgage amount.

Rent Arrears: Overdue rent amount.

Council Tax Arrears: Overdue council tax amount.

Utilities Arrears: Overdue utilities amount.

Other Secured Loans: Overdue secured loan amount.

Magistrates Fines: Overdue magistrate fines.

Maintenance: Overdue maintenance amount.

Hire Purchase: Overdue vehicle "hire purchase" amount.

Other Arrears: Overdue other amount.

Total No of Credit/Store Cards: Total number of credit cards and store cards.

Credit/Store Cards Balance: Total balance owed on the credit cards and store cards.

Credit/Store Cards Monthly Payment: Monthly payment amount for the credit cards and store cards.

Total No of Loan Agreements: Total number of loan agreements.

Loan Agreements Balance: Total balance owed on the loan agreements.

Loan Agreements Monthly Payments: Monthly payment amount for the loan agreements.

Other Debts Balance: Balance of other debts.

Other Debts Monthly Payments: Monthly payment amount for other debts.

- Complete the information and then click **Save**.

View Income and Expenditure History

Use the **Income and Expenditure History** dialog box to view the account's income and expenditure history. You can also replace information on the tabs in the **Income and Expenditures** panel with historical information.

To view income and expenditure history

1. In the **Reference Panel** navigation bar, click **Available Panels** and then click **Income and Expenditure**.

The screenshot shows the 'Income And Expenditure' panel in the software interface. At the top, there is a navigation bar with 'Available Panels', 'Notes', and 'Income And Expenditure'. Below this is a toolbar with '+Add', 'History', and 'Help'. The main area is divided into two columns: 'Status' and 'Monthly Financials'. Under 'Status', there are dropdown menus for 'Employment Status' (set to 'Employed - Full Time') and 'Home Status' (set to 'Mortgage Sole'). Under 'Household', there are input fields for 'Adults' (1), 'Children Under 14' (0), 'Children 14-18' (0), and 'Vehicles' (2). Under 'Monthly Financials', there are input fields for 'Total Income', 'Total Expenditure', 'Total Priority Debt', 'Total Other Debt', and 'Disposable Income', all set to '£ 0'. A 'Date Of Next Review' field is set to '19/11/2015'.

2. In the **Income and Expenditure** toolbar, click **History**. The **Income and Expenditure History** dialog box appears.
3. In the **Select a Date** list box, click a date. Historical information for the specified date appears.

The screenshot shows the 'Income and Expenditure History' dialog box. At the top, there is a 'Select a Date' dropdown menu with the date '2014-11-19T19:29:35.25' selected. Below this is a toolbar with 'Summary', 'Income', 'Expenses', and 'Arrears'. The main area is divided into two columns: 'Status' and 'Monthly Financials'. Under 'Status', there are dropdown menus for 'Employment Status' (set to 'Employed - Full Time') and 'Home Status' (set to 'Mortgage Sole'). Under 'Household', there are input fields for 'Adults' (1), 'Children Under 14' (0), 'Children 14-18' (0), and 'Vehicles' (2). Under 'Monthly Financials', there are input fields for 'Total Income', 'Total Expenditure', 'Total Priority Debt', 'Total Other Debt', and 'Disposable Income', all set to '£ 0'. At the bottom, there are two buttons: 'Make Current' (highlighted in yellow) and 'Cancel'.

4. Click a tab to view its information.
5. To replace information on the **Income and Expenditures** panel with this historical information, click **Make Current**.

Interactions and Events

Interactions and Events

Use the **Interactions** panel to view interactions with the account (for example, the system or a user added a note). An interaction is a group of events that occur while an account is open in the Agent Desktop. Use the **Events** panel to view the actions that occurred on the account (for example, a user changed the account status). You can use this information for auditing purposes.

View Account Interactions

Use the **Interactions** panel to view interactions for the account. Interactions include phone calls, texts, email messages, and letters.

To view account interactions

1. In the **Reference Panel** navigation bar, click **Available Panels** and then click **Interactions**. The **Interactions** panel appears.

Method	User	Started	Ended	Duration
quick search	GSadmin	4/26/18 8:36 am	-	-
quick search	GSadmin	4/26/18 8:35 am	4/26/18 8:36 am	00:00:12

Restrict to Users: If selected, only displays the interactions that the specified user created.

Restrict to Methods: If selected, only displays the interactions that match the specified method.

Restrict to Event Types: If selected, only displays the interactions that match the specified event type.

Date: If selected, only displays the interactions that match the specified date.

To Date: When used with the **Date** filter, only displays the interactions that fall within the specified date range. For example, if the Date value is 01/01/2018 and the To Date value is 04/24/2018, only interactions with a date that falls on or between 01/01/2018 and 04/24/2018 display.

Clear Filters: Clears the specified filters and displays all interactions.

Icons: Icons that indicate whether a user worked the account, attempted to contact a party on the account, or contacted a party on the account based on the interaction. For more information, see [Interaction Icons](#).

Method: Interaction that occurred.

User: User who started the interaction.

Started: Date and time the interaction started.

Ended: Date and time the interaction ended.

Duration: Length of time between the start and end of the interaction.

2. To display only the interactions that meet specific criteria, do one or more of the following:

- To limit the interactions to a specific user, in the **Restrict to Users** box, click the user.
- To limit the interactions to a specific method, in the **Restrict to Methods** box, click the method.
- To limit the interactions to a specific event type, in the **Restrict to Event Types** box, click the event type.
- To limit the interactions to a specific date, click in the **Date** box and then select the date from the calendar.
- To limit the interactions to a specific date range, click in the **Date** box and then select the start date from the calendar. Click in the **To Date** box and then select the end date from the calendar.

Only the interactions that match the selected criteria appear in the panel.

Tip: To clear the selected filters, click **Clear Filters**. All interactions appear in the panel.

3. To view more information for an interaction, click the plus sign (+) in the first column. More information for the interaction appears.

Date	User	Account	Event	Detail
6/25/18 2:04 pm	GSAdmin	1200	Interaction Started	+

4. To view details for an interaction, click the plus sign (+) in the Detail column. Detailed information for the interaction appears.

Date	User	Account	Event	Detail
6/25/18 2:04 pm	GSAdmin	1200	Interaction Started	+ Account Id: 1200 Interaction Id: 160 Method: quick search Method Data Term: F-1200 Started: 2018-06-25T18:04:06.3088147Z

Tip: To hide the details, click the minus sign (-).

View Events for an Account

Use the **Events** panel to view events that occurred on the account.

To view events for an account

1. In the **Reference Panel** navigation bar, click **Available Panels** and then click **Events**.

Available Panels ▾				
Notes ✕		Events ✕		
Filter By: Event Type		Select an option	Display Notes From Linked Accounts ✓	
Date	User	Event	Detail	
4/26/18 8:41 am	gs-GSAdmin	Account Note Added	+ DT-DEBTOR TELEPHONED OFFICE / TT-TALK TO - Added Employer	
4/26/18 8:40 am	gs-GSAdmin	Party Employment Verified	+ Party Employment Verified	
4/26/18 8:38 am	gs-GSAdmin	Queue Levels Changed	+ Queue level changed from 875 Linked Account (Non Driver) to 875 Linked Account (Non Driver)	
4/26/18 8:38 am	gs-GSAdmin	Account Statuses Changed	+ Status changed from NEW NEW STATUS ** (False) to ACT ACTIVE ACCOUNT ** (False)	

Previous 1 Next

Event Type: If selected, only displays events that match the specified event type.

Display Notes From Linked Accounts: If selected, displays notes for this account and the accounts linked to this account. If cleared, displays notes for this account only.

Date: Date and time the event occurred. To change the sort order, click the arrow in the Date column heading.

User: ID and name of the user who started the event.

Event: Event that occurred.

Detail: Information about the event.

- To limit the interactions to a specific event type, in the **Event Type** box, click the event type. Only the events that match the specified event type appear in the panel.

Tip: To clear the filter, click in the **Event Type** box and then click the blank option. All events appear in the panel.

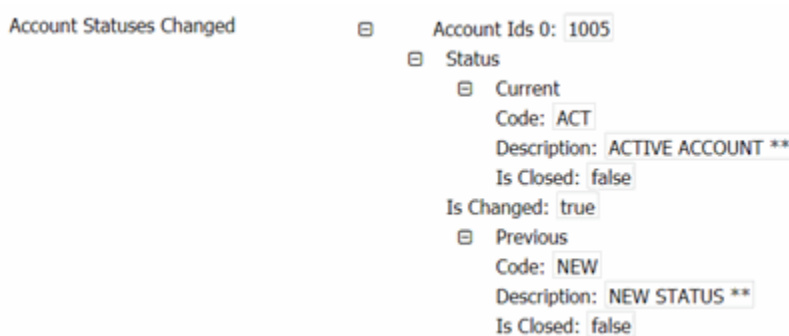

- To view details for an event, in the Detail column, click the plus sign (+). The event details appear.



Tip: To hide the details, click the minus sign (-).

Interaction Icons

The following table lists the interaction icons and their description. An interaction can have up to three icons.

Icon	Description
	Attempted. A user attempted to contact a party on the account.
	Contacted. A user contacted a party on the account.
	Worked. A user worked the account (for example, updated data successfully).

Medical

Medical

Use the **Medical** panel to add and modify medical patient, medical insurance, next of kin, and medical facility information for the account.

Add Patient Information

Use the **Patient Information** tab in the **Medical** panel to add patient information to the account.

To add patient information

1. In the **Reference Panel** navigation bar, click **Available Panels** and then click **Medical**.
2. Click the **Patient Information** tab.

The screenshot shows a web interface for adding patient information. At the top, there is a navigation bar with 'Available Panels' and 'Medical'. Below this is a 'Patient Information' tab. The form is organized into two columns of input fields. The left column contains fields for Name, Address (Street Line 1, Street Line 2, City, State, Postal Code, County, Country), Patient Id, Guarantor Id, Admission Date, Service Date, Discharge Date, Patient Type, Accident Date, Accident Type, Place of Service Code, Procedure Code, Financial Class, Servicing Provider Code, Import Procedures, Location Code, and Modifier. The right column contains fields for SSN, Gender, DOB, Age, Phone, Marital Status, Employer, Work Phone, Patient Relation to Guarantor, Additional Information, Diagnosis Code 1, Diagnosis Code 2, and Diagnosis Code 3. A 'Save' button is located at the bottom center of the form.

Name: Patient's name.

Address: Patient's street address line 1, line 2, city, state, postal code, county, and country.

Patient ID: Code that the medical facility assigned to identify the patient.

Admission Date: Date the medical facility admitted the patient.

Service Date: Date the patient received medical care.

Discharge Date: Date the medical facility discharged the patient.

Patient Type: Code assigned during the registration or admission process to identify the type of patient (for example, emergency or day surgery).

Accident Date: Date the patient had an accident that required medical attention.

Accident Type: Type of accident that the patient had.

Place of Service Code: Code that identifies the place that rendered service to the patient.

Procedure Code: Code that identifies the medical procedure that the patient received.

Financial Class: Code that identifies the patient's primary insurance to bill first for services.

Servicing Provider Code: Code that identifies the health care provider.

Import Procedures: Code that identifies a specific surgical, medical, or diagnostic intervention.

Location Code: Code that identifies the location where the patient received medical care.

Modifier: Code that identifies a medical service or procedure.

SSN: Patient's social security number.

Gender: Patient's gender.

DOB: Patient's date of birth.

Age: Patient's age.

Phone: Patient's phone number.

Marital Status: Patient's marital status.

Employer: Name of patient's employer.

Work Phone: Patient's work phone number.

Patient Relation to Guarantor: Patient's relationship to the person guaranteeing payment for medical care.

Additional Information: More information regarding the patient.

Diagnosis Code 1-3: Code that identifies the patient's medical diagnosis.

3. Complete the information and then click **Save**.

Modify Patient Information

Use the **Patient Information** tab in the **Medical** panel to modify patient information for the account.

To modify patient information

1. In the **Reference Panel** navigation bar, click **Available Panels** and then click **Medical**.
2. Click the **Patient Information** tab.

Latitude Printable Help

Available Panels ▾ Medical ✕

Help

Patient Information Insurance Next of Kin Facility

Name	John Doe	SSN	111223333
Address:	1000 Main St Street Line 2 Jacksonville FL 32256 Duval USA	Gender	Male ▾
		DOB	6/1/1991
		Age	26
		Phone	+1 (555) 555-5555
		Marital Status	Single ▾
Patient Id	123	Employer	ABC Co.
Guarantor Id	456	Work Phone	+1 (555) 999-9999
Admission Date	6/6/2016	Patient Relation to Guarantor	Self
Service Date	6/7/2016	Additional Information	
Discharge Date	6/8/2016		
Patient Type:	15	Diagnosis Code 1	06
Accident Date	6/6/2016	Diagnosis Code 2	05
Accident Type	14	Diagnosis Code 3	04
Place of Service Code	13		
Procedure Code	12		
Financial Class	11		
Servicing Provider Code	10		
Import Procedures	09		
Location Code	08		
Modifier	07		

Save

Name: Patient's name.

Address: Patient's street address line 1, line 2, city, state, postal code, county, and country.

Patient ID: Code that the medical facility assigned to identify the patient.

Admission Date: Date the medical facility admitted the patient.

Service Date: Date the patient received medical care.

Discharge Date: Date the medical facility discharged the patient.

Patient Type: Code assigned during the registration or admission process to identify the type of patient (for example, emergency or day surgery).

Accident Date: Date the patient had an accident that required medical attention.

Accident Type: Type of accident that the patient had.

Place of Service Code: Code that identifies the place that rendered service to the patient.

Procedure Code: Code that identifies the medical procedure that the patient received.

Financial Class: Code that identifies the patient's primary insurance to bill first for services.

Servicing Provider Code: Code that identifies the health care provider.

Import Procedures: Code that identifies a specific surgical, medical, or diagnostic intervention.

Location Code: Code that identifies the location where the patient received medical care.

Modifier: Code that identifies a medical service or procedure.

SSN: Patient's social security number.

Gender: Patient's gender.

DOB: Patient's date of birth.

Age: Patient's age.

Phone: Patient's phone number.

Marital Status: Patient's marital status.

Employer: Name of patient's employer.

Work Phone: Patient's work phone number.

Patient Relation to Guarantor: Patient's relationship to the person guaranteeing payment for medical care.

Additional Information: More information regarding the patient.

Diagnosis Code 1-3: Code that identifies the patient's medical diagnosis.

3. Modify the information and then click **Save**.

Add an Insurance Policy

Use the **Insurance** tab in the **Medical** panel to add an insurance policy to the account.

To add an insurance policy

1. In the **Reference Panel** navigation bar, click **Available Panels** and then click **Medical**.
2. Click the **Insurance** tab.

The screenshot shows a web interface for a 'Medical' record. At the top, there is a navigation bar with 'Available Panels' and 'Medical'. Below this are tabs for 'Patient Information', 'Insurance', 'Next of Kin', and 'Facility'. A '+ Add' button is visible. The main content area is divided into three columns: 'Insurance Policy', 'Insured Information', and 'Carrier Information'. Each column contains various input fields for text, dates, and dropdown menus. At the bottom, there is a 'Save' button.

3. Click + Add.

Add New Insurance Record

This screenshot shows the same 'Add New Insurance Record' form as above, but with all input fields empty and ready for data entry. The layout and labels are identical to the previous image.

Program Name: Name of the insured person's insurance program.

Employer Health Plan: Name of the employer's healthcare plan.

Group Number: Number that identifies the employer's group insurance plan.

Group Name: Name of the employer's group insurance plan.

Policy Number: Number that the insurance company assigned to identify the insured person's health insurance policy.

Coordination Number: Number that identifies the health insurance plan when a patient has more than one (for example, a primary and secondary healthcare plan).

Timely Filing Date: Deadline for billing the insurance company.

Additional Information: More information about the patient's health insurance.

Name: Insured person's name.

Insured Address: Insured person's street address line 1, line 2, city, state, postal code, county, and country.

Phone: Insured person's phone number.

Work Phone: Insured person's work phone number.

Insured DOB: Insured person's date of birth.

Employer: Name of Insured person's employer.

Gender: Insured person's gender.

SSN: Insured person's social security number.

Category: Type of insurance (for example, primary or secondary). The values available in the list box are based on what your organization defined using List Codes.

Carrier Name: Insurance carrier's name.

Carrier Address: Insurance carrier's street address line 1, line 2, city, state, postal code, county, and country.

Phone: Insurance carrier's phone number.

Carrier Fax: Insurance carrier's fax number.

Provider: Name of the healthcare provider.

Referring Provider: Name of the referring healthcare provider.

Accept Assignment: If selected, the healthcare provider agreed to accept assignment from the insurance provider.

Authorize Payment to Provider: If selected, the insurance provider authorized payment to the healthcare provider.

Patient Relationship: Patient's relationship to the insured person.

4. Complete the information and then click **Save**. The system adds a tab for the insurance policy on the **Insurance** tab in the **Medical** panel.

Modify an Insurance Policy

Use the **Insurance** tab in the **Medical** panel to modify an insurance policy for the account.

To modify an insurance policy

1. In the **Reference Panel** navigation bar, click **Available Panels** and then click **Medical**.
2. Click the **Insurance** tab.
3. Click the tab for the policy to edit.

4. Click **Edit**.

Update Insurance Record

Insurance Policy		Insured Information		Carrier Information	
Program Name	BCBS	Name	John Doe	Category	Primary
Employer Health Plan	Anthem	Insured Address	1000 Main St	Carrier Name	XYZ Co.
Group Number	4545	Street Line 2	Street Line 2	Carrier Address	2000 Main St
Group Name	8787	City	Jacksonville	Street Line 2	Street Line 2
Policy Number	1234	State	FLORIDA	City	Jacksonville
Coordination Number	1515	Postal Code	32256	State	FLORIDA
Timely Filing Date	8/30/2017	Country	USA	Postal Code	32256
Additional Information		Phone	Duval	Country	USA
		Work Phone	5555555555	Carrier Fax	
		Insured DOB	5559999999	Provider	Anthem
		Employer	6/1/1991		
			ABC Co.		

Save Help Cancel

Program Name: Name of the insured person's insurance program.

Employer Health Plan: Name of the employer's healthcare plan.

Group Number: Number that identifies the employer's group insurance plan.

Group Name: Name of the employer's group insurance plan.

Policy Number: Number that the insurance company assigned to identify the insured person's health insurance policy.

Coordination Number: Number that identifies the health insurance plan when a patient has more than one (for example, a primary and secondary healthcare plan).

Timely Filing Date: Deadline for billing the insurance company.

Additional Information: More information about the patient's health insurance.

Name: Insured person's name.

Insured Address: Insured person's street address line 1, line 2, city, state, postal code, county, and country.

Phone: Insured person's phone number.

Work Phone: Insured person's work phone number.

Insured DOB: Insured person's date of birth.

Employer: Name of Insured person's employer.

Gender: Insured person's gender.

SSN: Insured person's social security number.

Category: Type of insurance (for example, primary or secondary). The values available in the list box are based on what your organization defined using List Codes.

Carrier Name: Insurance carrier's name.

Carrier Address: Insurance carrier's street address line 1, line 2, city, state, postal code, county, and country.

Phone: Insurance carrier's phone number.

Carrier Fax: Insurance carrier's fax number.

Provider: Name of the healthcare provider.

Referring Provider: Name of the referring healthcare provider.

Accept Assignment: If selected, the healthcare provider agreed to accept assignment from the insurance provider.

Authorize Payment to Provider: If selected, the insurance provider authorized payment to the healthcare provider.

Patient Relationship: Patient's relationship to the insured person.

5. Modify the information and then click **Save**.

Invalidate an Insurance Policy

Use the **Insurance** tab in the **Medical** panel to flag an insurance policy as invalid for the account.

To invalidate an insurance policy

1. In the **Reference Panel** navigation bar, click **Available Panels** and then click **Medical**.
2. Click the **Insurance** tab.
3. Click the tab for the policy to invalidate.

The screenshot shows a web interface for managing insurance policies. At the top, there are tabs for 'Available Panels' and 'Medical'. Below that, there are sub-tabs for 'Patient Information', 'Insurance', 'Next of Kin', and 'Facility'. The 'Insurance' tab is selected, showing a list of policies with '1 - XYZ Co.' and an '+ Add' button. The main content area is divided into three columns: 'Insurance Policy', 'Insured Information', and 'Carrier Information'. Each column contains various input fields for policy details, insured person information, and carrier details. At the bottom of the 'Insurance Policy' section, there is an 'Invalidate Record' button. At the bottom center of the form, there is a 'Save' button.

4. Click **Invalidate Record**.

Invalidate Insurance

Reason:

- In the **Reason** box, type the reason the policy is invalid and then click **Save**. The system displays a red bar and a message across the top of the policy tab to indicate that the policy is invalid.

Add Next of Kin

Use the **Next of Kin** tab in the **Medical** panel to add next of kin information to the account.

To add next of kin

- In the **Reference Panel** navigation bar, click **Available Panels** and then click **Medical**.
- Click the **Next of Kin** tab.

Available Panels ▾ Medical ✕ Help

Patient Information Insurance **Next of Kin** Facility

Name

Phone

Address

Name: Full name of the patient's next of kin.

Phone: Phone number of the patient's next of kin.

Address: Street address line 1, line 2, city, state, postal code, county, and country of the patient's next of kin.

- Complete the information and then click **Save**.

Modify Next of Kin

Use the **Next of Kin** tab in the **Medical** panel to modify next of kin information for the account.

To modify next of kin

1. In the **Reference Panel** navigation bar, click **Available Panels** and then click **Medical**.
2. Click the **Next of Kin** tab.

The screenshot shows a software interface for editing patient information. At the top, there is a navigation bar with 'Available Panels' and 'Medical'. Below this is a 'Help' icon. The main area has four tabs: 'Patient Information', 'Insurance', 'Next of Kin', and 'Facility'. The 'Next of Kin' tab is active. The form contains the following fields:

- Name: Jane Doe
- Phone: +1 (555) 555-3333
- Address: 1000 Main St, Street Line 2, Jacksonville, FL 32256, Duval, USA

A 'Save' button is located at the bottom of the form.

Name: Full name of the patient's next of kin.

Phone: Phone number of the patient's next of kin.

Address: Street address line 1, line 2, city, state, postal code, county, and country of the patient's next of kin.

3. Modify the information and then click **Save**.

Add a Medical Facility

Use the **Facility** tab in the **Medical** panel to add a medical facility to the account.

To add a medical facility information

1. In the **Reference Panel** navigation bar, click **Available Panels** and then click **Medical**.
2. Click the **Facility** tab.

The screenshot shows a web interface for a medical reference panel. At the top, there is a navigation bar with 'Available Panels' and 'Medical'. Below this is a 'Help' icon. The main content area has four tabs: 'Patient Information', 'Insurance', 'Next of Kin', and 'Facility'. The 'Facility' tab is active, displaying two sections: 'Facility Information' and 'Admitting'. The 'Facility Information' section includes fields for Name, Facility Address (Street Line 1, Street Line 2, City, State, Postal Code, County, Country), Phone, and Fax. The 'Admitting' section includes fields for Doctor, Phone, Fax, Doctor Code, Attending Doctor, Phone, Fax, and Doctor Code. A 'Save' button is located at the bottom of the form.

Name: Name of the medical facility.

Facility Address: Medical facility's street address line 1, line 2, city, state, postal code, county, and country.

Phone: Medical facility's phone number.

Fax: Medical facility's fax number.

Doctor: Name of the doctor who admitted the patient.

Phone: Admitting doctor's phone number.

Fax: Admitting doctor's fax number.

Doctor Code: Code that the medical facility assigned to identify the admitting doctor.

Attending Doctor: Name of the doctor who is rendering service to the patient.

Phone: Attending doctor's phone number.

Fax: Attending doctor's fax number.

Doctor Code: Code that the medical facility assigned to identify the attending doctor.

3. Complete the information and then click **Save**.

Modify a Medical Facility

Use the **Facility** tab in the **Medical** panel to modify a medical facility for the account.

To modify a medical facility information

1. In the **Reference Panel** navigation bar, click **Available Panels** and then click **Medical**.
2. Click the **Facility** tab.

The screenshot shows a web interface with a top navigation bar containing 'Available Panels' and 'Medical'. Below this is a sub-navigation bar with tabs for 'Patient Information', 'Insurance', 'Next of Kin', and 'Facility'. The main content area is divided into two columns: 'Facility Information' and 'Admitting'. The 'Facility Information' column contains input fields for Name, Facility Address (with sub-fields for Street Line 1, Street Line 2, City, State, County, and Country), Phone, and Fax. The 'Admitting' column contains input fields for Doctor, Phone, Fax, Doctor Code, Attending Doctor, Phone, Fax, and Doctor Code. A 'Save' button is positioned at the bottom center of the form area.

Name: Name of the medical facility.

Facility Address: Medical facility's street address line 1, line 2, city, state, postal code, county, and country.

Phone: Medical facility's phone number.

Fax: Medical facility's fax number.

Doctor: Name of the doctor who admitted the patient.

Phone: Admitting doctor's phone number.

Fax: Admitting doctor's fax number.

Doctor Code: Code that the medical facility assigned to identify the admitting doctor.

Attending Doctor: Name of the doctor who is rendering service to the patient.

Phone: Attending doctor's phone number.

Fax: Attending doctor's fax number.

Doctor Code: Code that the medical facility assigned to identify the attending doctor.

3. Modify the information and then click **Save**.

Miscellaneous Extra Data

Miscellaneous Extra Data

Use the **Misc Extra** panel to view, add, and modify miscellaneous data associated to the account. Miscellaneous extra data is any type of information related to the account that you cannot record elsewhere within the system. The ability to add or modify miscellaneous extra data is based on your permissions.

Add Miscellaneous Extra Data

Use the **Add Misc Extra** dialog box to add miscellaneous extra data to the account. You can add miscellaneous information manually, or it can come from an import of customer data (including unmapped data). You must have the Create Misc Extra Data Permission.

To add miscellaneous extra data

1. In the **Reference Panel** navigation bar, click **Available Panels** and then click **Misc Extra**.

Extra Title	Extra Information	
Original Account#	7738179391196	Edit
Social	165406699	Edit
DOB	2/14/1978	Edit
Current Balance	2455.77	Edit
Charge Off Date	1/25/2009 12:00:00 AM	Edit

2. In the **Misc Extra** toolbar, click **Add Misc Extra**.

Add Misc Extra

Extra Title

Extra Information

Save Cancel Help

Extra Title: Label that represents the extra data.

Extra Information: Extra data value.

3. Complete the information and then click **Save**.

Modify Miscellaneous Extra Data

Use the **Edit Misc Extra** dialog box to modify miscellaneous extra data for the account. You must have the Update Misc Extra Data Permission.

To modify miscellaneous extra data

1. In the **Reference Panel** navigation bar, click **Available Panels** and then click **Misc Extra**.

Latitude Printable Help

Available Panels ▾		Misc Extra ✕	Help
+ Add Misc Extra			
Extra Title	Extra Information		
Original Account#	7738179391196	Edit	
Social	165406699	Edit	
DOB	2/14/1978	Edit	
Current Balance	2455.77	Edit	
Charge Off Date	1/25/2009 12:00:00 AM	Edit	

2. Click **Edit** for the extra data to modify.

Edit Misc Extra

Extra Title	<input type="text" value="Current Balance"/>
Extra Information	<input type="text" value="1307.21"/>

[Save](#) [Cancel](#) [Help](#)

Extra Title: Label that represents the extra data.

Extra Information: Extra data value.

3. Modify the information and then click **Save**.

Notes

Notes

Use the **Notes** panel to view notes and the **Add Note** dialog box to add notes to the account. The ability to view, add, or modify notes is based on your permissions.

View Account Notes

Use the **Notes** panel to view and filter notes for the account. You can filter notes by action code, result code, joined account, system-created, or user-created. You must have the View Private Notes Permission to view private notes.

To view account notes

1. In the **Reference Panel** navigation bar, click **Available Panels** and then click **Notes**.

Available Panels ▾		Notes ✖															
+ Add Note		+ Review Note		Q		Joined Account		Select an option		Created By		All		Clear Filters		Help	
Date	Account	User	Action	Result	Comment	Private?											
4/27/12 1:07 pm	1008	FUSION	SEND	SEND	Equifax FirstSearch Service data ordered on 04/27/2012. Current Balance = 476.55												
4/27/12 1:07 pm	1005	FUSION	SEND	SEND	Equifax FirstSearch Service data ordered on 04/27/2012. Current Balance = 1307.21												
2/11/11 10:13 am	1005	EXCHANGE-S	CO	CO	NEW BIZ IMPORT												
2/11/11 10:13 am	1008	EXCHANGE-S	CO	CO	NEW BIZ IMPORT												

Previous 1 Next

Joined Account: If selected, only displays notes for the specified joined account.

Created By: If selected, only displays notes for the specified user that created the note.

Clear Filters: Clears the specified filters and displays all notes.

Date: Date and time the system or a user created the note. Dates and times are based on your time zone.

Account: Number that the client assigned to identify the account.

User: User who created the note.

Action: Code that identifies the action taken on the account.

Result: Code that identifies the result of the action taken on the account.

Comment: Note detail.

Private: If selected, indicates that unauthorized users cannot view the note.

- To display only the notes that meet specific criteria, in the **Search** box, type a word or phrase and then click the Search icon. Only notes that match the search criteria display in the data grid.
- To display notes for a specific joined account only, in the **Joined Account** list box, click the joined account. Only notes for the specified joined account display in the data grid.
- To display notes based on who created them, in the **Created by** list box, do the following:
 - To display only the notes that the system created, click **System**. Only notes that the system created display in the data grid.
 - To display only the notes that users created, click **Users**. Only notes that users created display in the data grid.
 - To display all notes, click **All**. Notes that the system or users created display in the data grid.

Tip: To clear the filters, click **Clear Filters**.

Add an Account Note

Use the **Add Note** dialog box to add an unlimited number of notes to the account. You must have the Create Notes Permission. To flag a note as private, you must also have the Create Private Notes Permission.

To add an account note

1. In the **Reference Panel** navigation bar, click **Available Panels** and then click **Notes**.
2. In the **Notes** toolbar, click **Add Note**.

Add Note

The screenshot shows the 'Add Note' dialog box with the following fields and controls:

- Action Code:** A dropdown menu with the text "-- Choose Action - Required --".
- Result Code:** A dropdown menu with the text "-- Choose Result - Required --".
- Comments:** A large text area for entering note details.
- Is Private:** A checkbox.
- Buttons:** "Save" (yellow), "Cancel", and "Help" (with a question mark icon).

Action Code: Code that identifies the action taken on the account.

Result Code: Code that identifies the result of the action taken on the account. The system adds text to the **Comment** box for certain result codes.

Comments: Note detail. You can type an unlimited number of characters in this box.

Is Private: If selected, unauthorized personnel cannot view the note.

3. Complete the information and then click **Add Note**.

Redact an Account Note Comment

Use the **Review Note** dialog box to redact (obscure) all or a portion of a note comment. You must have the Allow Redaction Permission.

To redact an account note comment

1. In the **Reference Panel** navigation bar, click **Available Panels** and then click **Notes**.
2. In the data grid, click a note.
3. In the **Notes** toolbar, click **Review Note**.

Review Note

Action Code

Result Code

Comments

Is Private

4. In the **Comments** box, select the text to obscure and then click **Redact**.
5. In the confirmation dialog box, click **OK**. The system displays each character in the selected text as an "X". The original text remains untouched in the database.

Action and Result Codes

Action and result codes classify the work done on an account. The system and users attach notes to accounts. Action codes indicate the action on an account, while result codes indicate what happened as a result of the action. The system also uses result codes to count the number of accounts each collector works and contacts.

The following tables list the standard action and result codes.

Standard action codes

* Indicates system-utilized action codes.

Code	Description
3P	Third Party
AT	Attorney Telephoned
CO*	Comment Only
DT	Customer Telephoned Office
RL	Received Letter
SC	Supervisor Call
TA	Telephoned Attorney

Latitude Printable Help

TC*	Telephoned Client
TE*	Telephoned Employer
TI*	Telephoned Information
TR*	Telephoned Residence
TO	Telephoned Other

Standard result codes

* Indicates system-utilized action codes.

Code	Description	Worked	Contacted
AM*	Left message on Answering Machine	Yes	No
CO*	Comment Only	Yes	Yes
HU	Hung Up on	Yes	No
LB	Line Busy	Yes	Yes
LM	Left Message	Yes	Yes
LR	Left message on Recorder	No	No
LV	Left message on Voice Mail	No	No
NA*	No Answer	No	No
NH	No Help	Yes	Yes
NI	Not In	No	No
NL	No Listing	No	No
NP	Non-Published	No	No
TD	Temporarily Disconnected	No	No
TO	Telephoned Office	No	No
TT	Talked To	No	No

TW	Talked With (other than customer)	Yes	No
WN*	Wrong Number or no good	Yes	No

Payment History

Payment History

Use the **Payment History** panel to view payment history and payment history details for the account.

View Payment History for an Account

Use the **Payment History** panel to view payment history for the account.

To view payment history for an account

- In the **Reference Panel** navigation bar, click **Available Panels** and then click **Payment History**.

@UID	Effective Date	Entered Date	Total Paid	Batch Type	Method	Comment
16	2/4/15	2/4/15	\$50.00	Paid Us	CREDIT CARD	

UID: Code that identifies the payment transaction. Click the link in this column to view payment details.

Effective Date: Date and time the payment transaction occurred.

Entered Date: Date and time a user added the payment transaction to the system.

Total Paid: Payment amount.

Batch Type: Type of batch associated to the payment transaction.

Method: Payment method.

Comment: More information regarding the payment transaction.

View Payment History Detail for an Account

Use the **Transaction Detail** dialog box to view payment detail for the account.

To view payment history detail for an account

- In the **Reference Panel** navigation bar, click **Available Panels** and then click **Payment History**.

@UID	Effective Date	Entered Date	Total Paid	Batch Type	Method	Comment
16	2/4/15	2/4/15	\$50.00	Paid Us	CREDIT CARD	

- In the UID column, click the link. The **Transaction Detail** dialog box appears.

Transaction Detail - 16 - Paid Us

System Month:	2			
Date Entered:	2/4/15	Principal	\$50.00	\$12.50
Entered By:	gs	Interest	\$0.00	\$0.00
Batch Type:	PU	Collection Costs	\$0.00	\$0.00
Batch Number:	15	Bad Check Chgs	\$0.00	\$0.00
Processed By:	gs	Court Cost	\$0.00	\$0.00
UID	16	Attorney Fees	\$0.00	\$0.00
Matched	N	Misc	\$0.00	\$0.00
Date Paid:	2/4/15		\$0.00	\$0.00
Date Invoiced:			\$0.00	\$0.00
Customer:	0000001	Transaction Charges	\$0.00	\$0.00
Desk Code:	0000000	Over Paid:	\$0.00	
Check Number		Total	\$50.00	\$12.50
Payment Method:	CREDIT CARD	Collector Fee:		\$12.50
Invoice Number:		Agency Fee:		\$0.00
Comment:				

Close Help

System Month: Processing month associated to the payment.

Date Entered: Date a user added the payment arrangement to the system.

Entered By: User who added the payment arrangement to the system. If you set up an API key and create a payment using another program (such as Exchange Manager), the user associated to the API key displays here.

Batch Type: Type of batch associated to the payment, which is also the payment type. For more information, see [Payment Type Codes](#).

Batch Number: Number that Latitude assigned to identify the payment batch.

Processed By: User who processed the payment batch. If you set up an API key and process a payment using another program (such as Exchange Manager), the user associated to the API key displays here.

UID: Code that identifies the payment transaction.

Matched: Indicates whether the system matched the payment to a reversal and, therefore, didn't include it on the invoice.

Date Paid: Payment date.

Date Invoiced: Date the system invoiced the customer.

Customer: Customer associated to the account.

Desk Code: Code that identifies the desk that added the payment.

Check Number: Check number associated to the payment.

Payment Method: Form of payment (for example, cash, check, credit card).

Invoice Number: Invoice number for the payment.

Comment: More information regarding the payment.

Money Buckets: Money buckets associated to the payment.

Paid: Amount of the payment assigned to the money bucket.

Fee: Collection fee associated to the money bucket amount.

Overpaid: Overpayment amount (amount paid less the account balance).

Total: Totals for payment and fee amounts.

Collector Fee: Total collector fees (sum of the fees for all the money buckets).

Agency Fee: Total agency fees.

- When finished viewing the information, click **Close**.

Phones

Phones

Use the **Phones** panel to view phone numbers for parties on the account and use the **Add Phone Number** dialog box to add phone numbers.

View Phone Numbers for an Account

Use the **Phones** panel to view phone numbers for parties on the account.

To view phone numbers for an account

- In the **Reference Panel** navigation bar, click **Available Panels** and then click **Phones**.

Number	Type	Consent	Status	Customer	Attempts	Last Attempt	Name	On Hold	Hold Expiration Date
(610) 557-8455 (On Hold)				Dugan, Susan	0				4/22/15

Number: Person's phone number. If a call is on hold, a Hold icon and a message appear next to the phone number.

Type: Type of phone number.

Consent: Indicates whether the customer granted permission to call or send a text message to the phone number. For more information, see [Phone Usage Consent Icons](#).

Status: Status of the phone number. For more information, see [Phone Number Status Icons](#).

Customer: Customer on the account.

Attempts: Number of times you attempted to call or text the phone number.

Last Attempt: Date and time you last attempted to call or text the phone number.

Name: Name of the person associated to the phone number.

On Hold: If the phone number is on hold, the hold icon appears.

Hold Expiration Date: Date the hold expires. If the phone number is on hold and there isn't an expiration date, the hold remains until a user or a process removes the hold.

Add a Phone Number to an Account

Use the **Add Phone Number** dialog box to add a party's phone number to the account. To add a phone number, you must have the Create Phone Numbers Permission.

To add a phone number to an account

1. Do one of the following:
 - In the **Task Panel** navigation tree, click **Customer** and then click a name. In the **Contact Information** tab, click **Add Phone**.
 - In the **Reference Panel** navigation bar, click **Available Panels** and then click **Phones**. In the **Phones** toolbar, click **Add Phone**.

The **Add Phone Number** dialog box appears.

Add Phone Number

Phone Number

Phone Extension

Type

Status

Customer on Account

Name

On Hold

Hold Expiration Date:

Consent To Call Granted

Consent To Auto Dial Granted

Consent To SMS Granted

Consent To FAX Granted

Obtained From

Phone Number: Person's phone number, including the country code. You can select the country from the list box or type a plus sign (+) and then the country code (for example, "+44" for United Kingdom).

Phone Extension: Phone extension.

Type: Type of phone number.

Status: Status of the phone number.

Customer on Account: Customer on the account.

Name: Name of the person associated to the phone number.

On Hold: If selected, the phone number is on hold.

Hold Expiration Date: Date the hold expires. If you don't specify a date, the hold remains until you clear the **On Hold** check box or remove the hold using another process.

Consent To Call: If selected, the person granted permission to call this phone number.

Consent To Auto Dial: If selected, the person granted permission to call this phone number using a dialer campaign.

Consent To SMS: If selected, the person granted permission to send a text message to this phone number.

Consent to fax: If selected, the person granted permission to send a fax to this phone number.

Obtained From: Person who granted or denied permission to contact this phone number.

Method: Indicates whether the person granted permission verbally or in writing.

Comment: More information regarding the phone number.

2. Complete the information and then click **Save**.

Modify a Phone Number on an Account

Use the **Edit Phone Number** dialog box to modify phone information for a party on the account. To modify phone numbers, you must have the Update Phone Numbers Permission. To modify phone consent options, you must have the Change Phone Consent Permission. The system records phone number changes in the **Notes** panel.

Note: If the system administrator configured the Mask Phone Numbers Permission, the system replaces all or parts of the phone number with asterisks (*), depending on the configuration.

To modify a phone number on an account

1. Do one of the following:
 - In the **Task Panel** navigation tree, click **Customer** and then click a name. The **Contact Information** tab appears.

- In the **Reference Panel** navigation bar, click **Available Panels** and then click **Phones**. The **Phones** panel appears.



2. Click the arrow next to the phone number and then click **Edit**.

Edit Phone Number

Phone Number +16105587744

Phone Extension 0

Type Home

Status Good

Customer on Account Eva M Severino

Name

On Hold

Hold Expiration Date:

Consent To Call Granted

Consent To Auto Dial Granted

Consent To SMS Granted

Consent To FAX Granted

Obtained From -- Choose Obtained From - Required --

Method Written Verbal

Save Cancel Help

Phone Number: Person's phone number, including the country code. You can select the country from the list box or type a plus sign (+) and then the country code (for example, "+44" for United Kingdom). You cannot modify the phone number.

Phone Extension: Phone extension. You cannot modify the phone extension.

Type: Type of phone number. To modify the phone type, you must have the Update Phone Type Permission.

Status: Status of the phone number. To modify the phone status, you must have the Update Phone Status Permission.

Customer on Account: Customer on the account.

Name: Name of the person associated to the phone number.

On Hold: If selected, the phone number is on hold.

Hold Expiration Date: Date the hold expires. If you don't specify a date, the hold remains until you clear the **On Hold** check box or remove the hold using another process.

Consent To Call: If selected, the person granted permission to call this phone number.

Consent To Auto Dial: If selected, the person granted permission to call this phone number using a dialer campaign.

Consent To SMS: If selected, the person granted permission to send a text message to this phone number.

Consent to fax: If selected, the person granted permission to send a fax to this phone number.

Obtained From: Person who granted or denied permission to contact this phone number.

Method: Indicates whether the person granted permission verbally or in writing.

Comment: More information regarding the phone number.

3. Modify the information and then click **Save**.

Change the Status of an Account Phone Number

Use the **Contact Information** tab or the **Phones** panel to change the status of a phone number on the account. You must have the Update Phone Status Permission.

To change the status of an account phone number

1. Do one of the following:
 - In the **Task Panel** navigation tree, click **Customer** and then click a name. The **Contact Information** tab appears.

- In the **Reference Panel** navigation bar, click **Available Panels** and then click **Phones**. The **Phones** panel appears.

Number	Type	Consent	Status	Customer	Attempts	Last Attempt	Name	On Hold	Hold Expiration Date
(610) 557-8455 (On Hold)				Dugan, Susan	0				4/22/15

2. Click the arrow next to the phone number and then click the status (**Good** or **Bad**).

Dial a Phone Number

Use the **Contact Information** tab or the **Phones** panel to dial a phone number on the account. You can dial a phone number directly under the following conditions:

- Dialer is present.
- User is not on a call currently through manual or campaign dialing.

Latitude Printable Help

- **Consent To Call** option is selected, indicating that the person granted permission to call the phone number.
- Phone status is "Good."

To dial a phone number

1. Do one of the following:
 - In the **Task Panel** navigation tree, click **Customer** and then click a name. The **Contact Information** tab appears.

The screenshot shows the 'Contact Information' tab in the Latitude system. The form is divided into several sections: 'Arrangements', 'Care and Financial Hardship', 'Complaints', 'Customer' (with a list of names including 'Zellers Jr, Leslie E' and 'Wiesen, Roy'), 'Disputes', 'Legal - New Court Case', 'Letters', and 'Payments'. The main form area contains fields for 'Prefix', 'First Name', 'Last Name', 'Middle Name', 'Suffix', 'Gender', 'AKA Name', 'Is Business', 'Business Name', and 'Preferred Contact Method'. There are also fields for 'Type', 'Number', 'Attempts', 'Consent', and 'Status'. The 'Address' section includes 'Street Line 1', 'Street Line 2', 'City', 'State', and 'Zip'. The 'Email' field is also present. On the right side, there are fields for 'Relation to Account', 'Is Responsible', 'Authorized', 'National Id', 'Date Of Birth', 'Drivers License', 'Language', 'Time Zone', and 'Observes DST'. At the bottom, there are 'Add', 'Save', and 'Help' buttons.

- In the **Reference Panel** navigation bar, click **Available Panels** and then click **Phones**. The **Phones** panel appears.

The screenshot shows the 'Phones' panel in the Latitude system. It features a table with the following columns: 'Number', 'Type', 'Consent', 'Status', 'Customer', 'Attempts', 'Last Attempt', 'Name', 'On Hold', and 'Hold Expiration Date'. The table contains one row of data: a phone number '(610) 557-8455 (On Hold)', type 'Dugan, Susan', 0 attempts, and a hold expiration date of 4/22/15. There are also 'Add Phone', 'Notes', and 'Phones' tabs at the top, and an 'Add Phone' button and a 'Help' icon on the right.

Number	Type	Consent	Status	Customer	Attempts	Last Attempt	Name	On Hold	Hold Expiration Date
(610) 557-8455 (On Hold)	Dugan, Susan				0				4/22/15

2. Click the arrow next to the phone number and then click **Dial Number**. If the conditions for dialing a phone number are met, Latitude places the call.

