



PureConnect®

2023 R3

Generated:

09-November-2023

Content last updated:

09-October-2020

See [Change Log](#) for summary of changes.



# Salesforce Connector

## Printed Help

### Abstract

This document contains the application help for Salesforce Connector.

For the latest version of this document, see the PureConnect Documentation Library at: <http://help.genesys.com/pureconnect>.

For copyright and trademark information, see [https://help.genesys.com/pureconnect/desktop/copyright\\_and\\_trademark\\_information.htm](https://help.genesys.com/pureconnect/desktop/copyright_and_trademark_information.htm).

# Table of Contents

Table of Contents	2
About the Salesforce Object Routing Connector	4
Overview	4
Get started	4
Troubleshoot	4
Release notes for the Salesforce Object Routing Connector	5
How the Salesforce Object Routing Connector works with Salesforce	6
How the Salesforce Object Routing Connector works with Salesforce	6
Concepts for the Salesforce Object Routing Connector	7
Connector group	7
Connector instance	7
Email interaction form	8
PushTopic	8
Trigger and custom object	9
Workflow for the Salesforce Object Routing Connector	9
Diagram of the connector pipeline for the Salesforce Object Routing Connector	10
Networking components of the Salesforce Object Routing Connector for CIC	12
Access a purchased connector	13
Access a purchased connector	13
Requirements for the Salesforce Object Routing Connector	13
PureCloud Bridge	13
CIC	13
Salesforce	13
Set up the Salesforce Object Routing Connector	13
PureCloud Bridge items	13
Salesforce-side items	13
CIC-side items	13
Set up the Salesforce Object Routing Connector	14
PureCloud Bridge items	14
Salesforce-side items	14
CIC-side items	14
Install the Bridge Server	14
Add a Salesforce Object Routing Connector	16
Configure the Salesforce Object Routing Connector	16
Configure the Salesforce Object Routing Connector	16
Access the Connector Details page	17
Configure the Salesforce Object Routing Connector	17
Add Configuration properties	17
Add CIC Credentials	17
Add Salesforce credentials	17
Add a connector instance	17
Install the managed package for the Salesforce Object Routing Connector	17
Install the Interaction Routing Queues tab for the Salesforce Object Routing Connector	17
Add queues to monitor for the Salesforce Object Routing Connector	18
Add skills-based routing for the Salesforce Object Routing Connector	18
Install the Salesforce Interaction Creator handler	18
Configure Redundancy for a Switchover Event	18
Troubleshoot the Salesforce Object Routing Connector	18
Connector log files	18
Server log files	18
Bridge Server outage	19
CIC server switchover	19
Connector failed to start	19
No interaction is routed	19
Email interactions stop routing	20
Unable to connect to the CIC server	22
Unable to connect to the Salesforce server	22
Push notification stop working after sandbox refresh	22
Troubleshoot the Salesforce Object Routing Connector	22
Connector log files	23
Server log files	23

Bridge Server outage	23
CIC server switchover	23
Connector failed to start	23
No interaction is routed	23
Email interactions stop routing	24
Unable to connect to the CIC server	26
Unable to connect to the Salesforce server	26
Push notification stop working after sandbox refresh	27
Change log	28

# About the Salesforce Object Routing Connector

## Overview

The Salesforce Object Routing Connector integrates Salesforce with CIC (Customer Interaction Center). The connector automates the process of routing various CRM (customer relationship management) objects (cases) from your CRM to CIC's ACD engine. The CIC engine intelligently queues these objects based on predetermined criteria. For example, the connector directs emails addressed to Support or Sales to the appropriate support or sales queue based on workgroup skills or utilization.

**Notice:** The Salesforce Object Routing Server is a replacement for the Salesforce Object Routing Connector. It eliminates the need for the PureCloud Bridge Server. Genesys will not support the PureCloud Bridge Server after January 1, 2021. To use the new Salesforce Object Routing Server, customers must use CIC 2018 R4 or a later release. For more information, see the [Salesforce Object Routing Server help](#).

- [Release notes](#)
- [How the connector works with Salesforce](#)
- [Concepts](#)
- [Workflow](#)
- [Connector pipeline](#)
- [Networking components](#)

## Get started

To use the Salesforce Object Routing Connector, access the purchased connector and then set up and configure items for PureCloud Bridge, Salesforce, and CIC.

- [Access a purchased connector](#) (login required)
- [Requirements](#)
- [Set up PureCloud Bridge, Salesforce, and CIC items](#)

## Troubleshoot

For any problems with the Salesforce Object Routing Connector, browse troubleshooting information about log files and individual issues.

- [Troubleshoot the connector](#)

# Release notes for the Salesforce Object Routing Connector

This article describes all Salesforce Object Routing Connector releases.

salesforceobjectrouting-cic2015r2

Version	Release Date	Description
15.2.0.369	12-July-2019	Update to managed package (v1.9). This update fixes a bug where interactions were not being created when comments were added to a case in Salesforce.
15.2.0.369	01-April-2019	Update to managed package (v1.8). This adds a new direct-to-queue option and fixes an routing issue where interactions were routed to the originating monitored queue after the case owner was changed to an unmonitored queue.
15.2.0.369	18-September-2018	Bug fixes to failover and notify in the event of a critical failure, as well as fixing errors related to writing to the event log.
15.2.0.359	27-July-2018	Fixed bug to adhere to changes to Salesforce's streaming API.
15.2.0.337	10-April-2017	Fixed a bug that could prevent emails from routing.
15.2.0.310	06-January-2016	Added compatibility for TLS 1.1 and 1.2. Made improvements to internal components.
15.2.0.299	12-November-2015	Added additional tracing around connection and reconnection logic.
15.2.0.295	26-October-2015	<b>Note:</b> Before upgrading to this version, you must update the handler and managed package. Added ability to assign skills to agents and route interactions based on these skills. Updated handler and managed package (v1.7).
15.2.0.221	09-July-2015	Added a timeout to fix a processing delay that occurs when the connector does not receive a response from Salesforce. Instead of waiting indefinitely for a response, the connector times out and proceeds with other requests in queue.
15.2.0.207	12-June-2015	Fixed a race condition that caused an exception to be thrown and message processing to be delayed until the connector was restarted. Refactored code to use a thread-safe collection.
15.2.0.203	27-May-2015	Fixed error handling when Salesforce reconnects after session timeout, network drop, and so on. Added ability to re-establish CIC connection when socket exceptions occur.
15.2.0.198	06-May-2015	Initial release of the CIC version of the connector

## How the Salesforce Object Routing Connector works with Salesforce

Salesforce receives incoming messages of various media types (chat, email, web form), creates cases for them, and routes the cases to queues. These queues are large undifferentiated buckets of cases. The cases sit in these queues until an agent processes them.

The Salesforce Object Routing Connector optimizes this process by placing email cases (Email-to-Case) in differentiated buckets (workgroups) to which you assign agents. The connector accomplishes this optimization by routing interactions through the CIC server. This routing allows the connector to take advantage of CIC's ACD engine and its intelligent queuing capability.

**Note:** The Salesforce Object Routing Connector only supports using a single CIC server with a single Salesforce organization. However, you can set up a second CIC server for switchover support.

For interactions to be created and routed to a case:

- The case associated with the interaction must appear in a queue specified on the Interaction Routing Queues tab.
- The case must be new or updated.
- For updated cases, one of the following must occur:
  - The case owner changed.
  - The case queue changed to a queue specified on the Interaction Routing Queues tab.
  - Someone other than the case owner added a comment.
  - An email response is received for the case.

To route the interactions to the CIC server, the connector uses Salesforce's native triggers, custom objects, and PushTopics in a managed package. The connector listens to queues in Salesforce for new or updated cases, and routes any incoming messages from that queue to the named workgroup in CIC. A message then pops up in the Salesforce interface for an agent in this particular workgroup.

The connector can route messages with designated required skills (for example, language or product knowledge). Agents in the workgroup who have the skills then receive these messages.

**Note:** Because the solution uses an email message as a container, the agent must respond to the case using the screen pop, not the email interaction form.

## How the Salesforce Object Routing Connector works with Salesforce

Salesforce receives incoming messages of various media types (chat, email, web form), creates cases for them, and routes the cases to queues. These queues are large undifferentiated buckets of cases. The cases sit in these queues until an agent processes them.

The Salesforce Object Routing Connector optimizes this process by placing email cases (Email-to-Case) in differentiated buckets (workgroups) to which you assign agents. The connector accomplishes this optimization by routing interactions through the CIC server. This routing allows the connector to take advantage of CIC's ACD engine and its intelligent queuing capability.

**Note:** The Salesforce Object Routing Connector only supports using a single CIC server with a single Salesforce organization. However, you can set up a second CIC server for switchover support.

For interactions to be created and routed to a case:

- The case associated with the interaction must appear in a queue specified on the Interaction Routing Queues tab.
- The case must be new or updated.
- For updated cases, one of the following must occur:
  - The case owner changed.
  - The case queue changed to a queue specified on the Interaction Routing Queues tab.
  - Someone other than the case owner added a comment.
  - An email response is received for the case.

To route the interactions to the CIC server, the connector uses Salesforce's native triggers, custom objects, and PushTopics in a managed package. The connector listens to queues in Salesforce for new or updated cases, and routes any incoming messages from that queue to the named workgroup in CIC. A message then pops up in the Salesforce interface for an agent in this particular workgroup.

The connector can route messages with designated required skills (for example, language or product knowledge). Agents in the workgroup who have the skills then receive these messages.

**Note:** Because the solution uses an email message as a container, the agent must respond to the case using the screen pop, not the email interaction form.

# Concepts for the Salesforce Object Routing Connector

The following sections explain key concepts for the Salesforce Object Routing Connector.

- [Connector group](#)
- [Connector instance](#)
- [Email interaction form](#)
- [PushTopic](#)
- [Trigger and custom object](#)

---

## Connector group

A **connector group** refers to a single configuration of a connector type that is set up and configured in PureCloud. For example, the connector group WebServicesDataDip refers to a single configuration of the connector type webservices-datadip.

For different configurations, use multiple connector groups of the same connector type. The connector groups can use the same Bridge Server or different Bridge Servers.

Connector groups must include a single instance of a connector, but can include multiple instances of a connector for resiliency purposes (if the connector supports failover and fault tolerance).

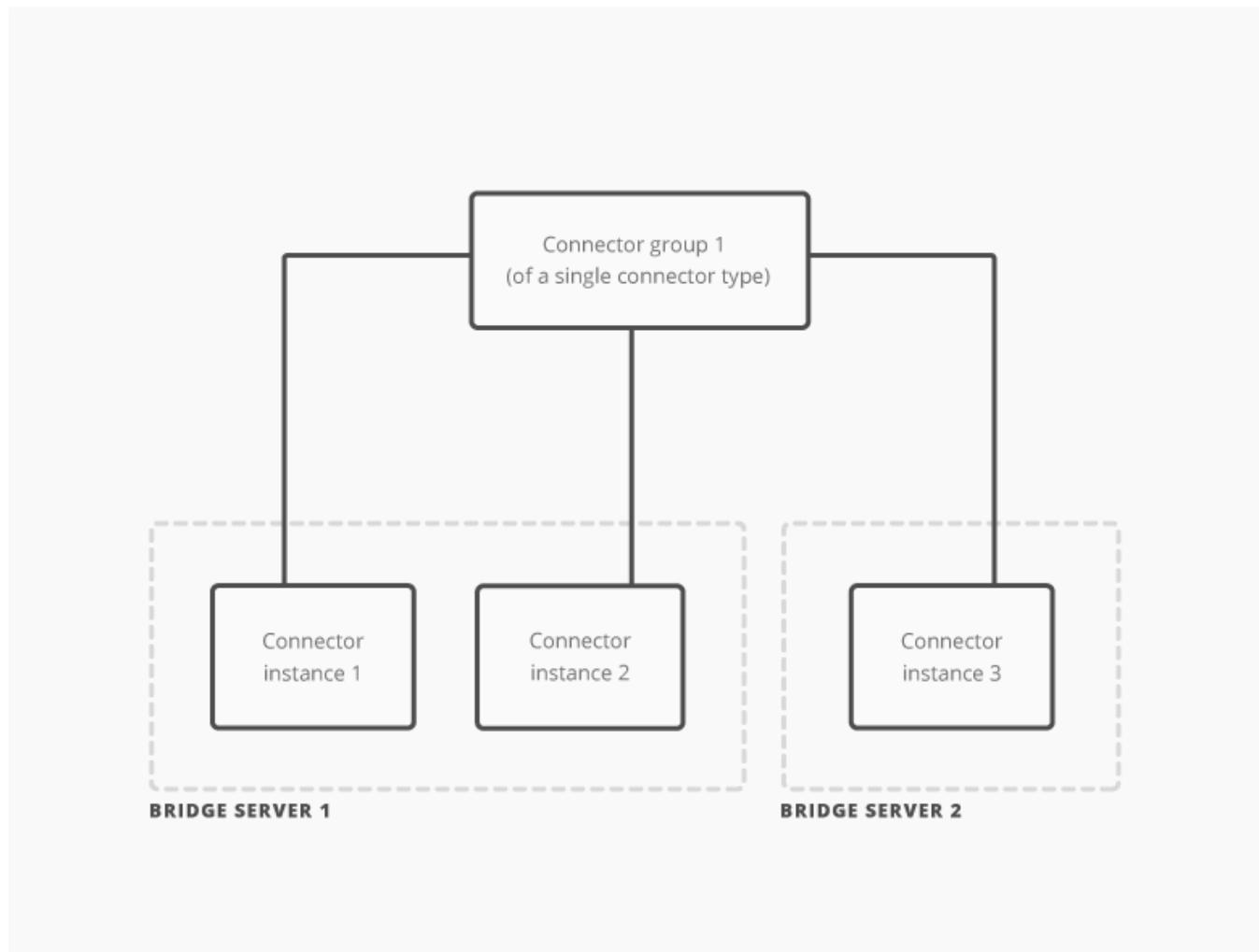

Connector groups, connector instances, and bridge servers



---

## Connector instance

A **connector instance** refers to a single occurrence of a connector in a connector group. Each connector group must have at least one connector instance.

All instances in a connector group share the same configuration and are of the same connector type. For example, all instances in the connector group WebServicesDataDip share the same configuration and are of the connector type webservicess-datadip.

Use multiple instances in a connector group for:

- connector failover support\*  
To do this, run multiple instances with the same Bridge Server or different Bridge Servers.
- Bridge Server fault tolerance\*  
To do this, run multiple instances with different Bridge Servers.

\* If supported by the connector

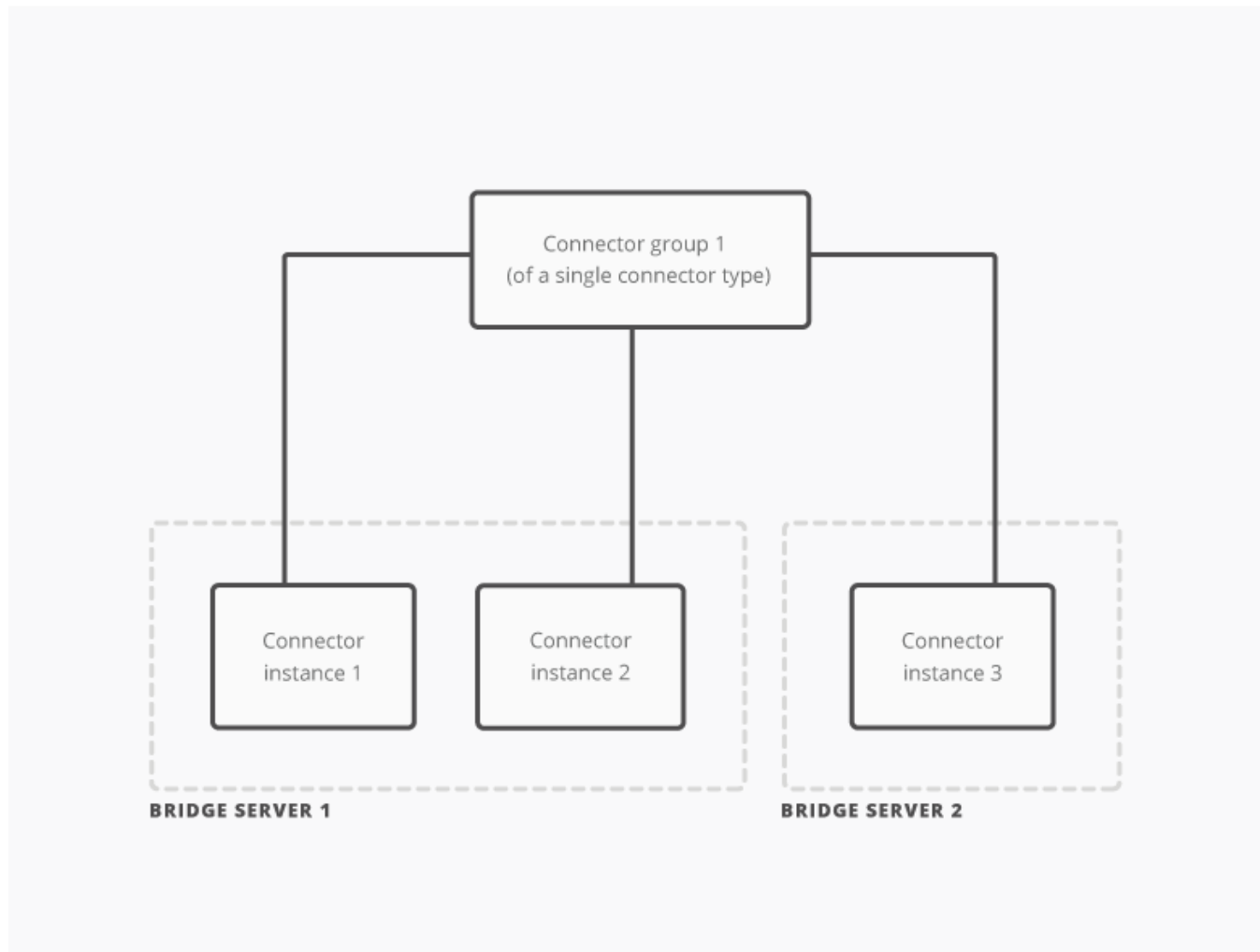

Connector groups, connector instances, and bridge servers



---

## Email interaction form

With the Salesforce Object Routing Connector, case information is converted to a CIC email interaction for ACD routing. Typically, when an agent selects an email interaction in Salesforce, an email interaction form dialog appears on the agent's screen.

The connector creates a screen pop for the Salesforce case and automatically suppresses the email interaction form. This behavior does not affect other email interactions created outside the connector.

---

## PushTopic



A PushTopic is a Salesforce-specific object that notifies listeners, such as the Salesforce Object Routing Connector, about changes to an object.

---

## Trigger and custom object

In Salesforce, once a case has been created, a trigger (event) is fired. A trigger listens for the creation of a case. After the trigger learns that a new case has been created, the trigger pulls certain data from the email and pushes it into a custom object (table).

**Note:** Currently, the trigger for the Salesforce Object Routing Connector can only create and update a custom object; the trigger cannot delete an object.

## Workflow for the Salesforce Object Routing Connector

The following is a common workflow using the object routing connector.

1. A customer sends an email.
  - a. Salesforce receives the email and creates a case.
  - b. The managed package detects the newly added case. If the case is in one of the monitored Salesforce queues, the managed package adds the case to a routing table.
2. The managed package alerts the connector of the new entry in the routing table. The managed package forwards information about the case, the CIC workgroup that the case is assigned to, and the skills for the interaction.
3. The connector raises a custom notification, which fires a handler on the CIC server. The handler creates the email interaction and assigns it to the CIC workgroup.
4. The ACD engine routes this email interaction to an agent who is using a Salesforce integration. The integration screen pops the case in the agent's browser.
5. IceLib notifies the connector that an interaction was successfully created.
6. The connector marks the entry in the routing table in Salesforce as processed.
7. The agent replies to the customer within Salesforce.
8. The managed package adds the updated case to the routing table and alerts the connector of the new entry in the routing table. The managed package forwards information about the case, the CIC workgroup that the case is assigned to, and the skills for the interaction.
9. The connector detects the reply and tells IceLib to disconnect the interaction (if EnableAutoDisconnectOnReply is selected in the connector configuration).
10. The connector marks the entry in the routing table in Salesforce as processed.

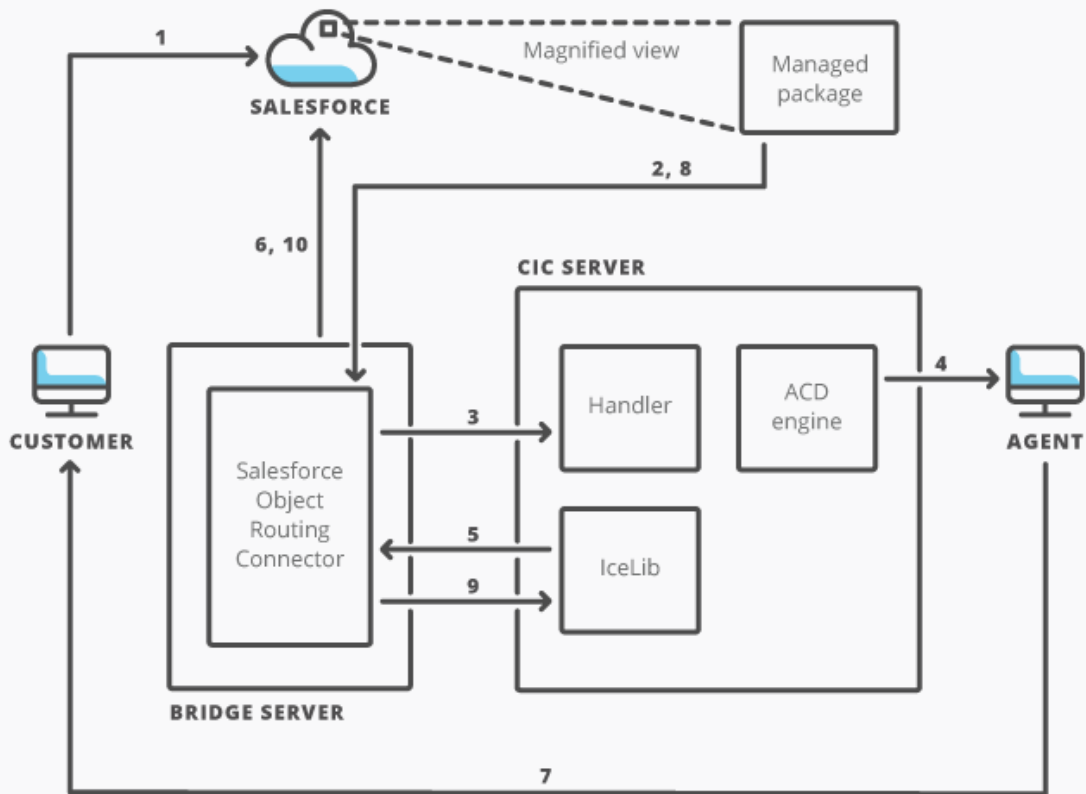

Workflow for the Salesforce Object Routing Connector

# Diagram of the connector pipeline for the Salesforce Object Routing Connector

The Salesforce Object Routing Connector:

- Creates objects containing data.
- Creates interactions representing these objects.
- Assigns interactions to workgroups on the CIC server.

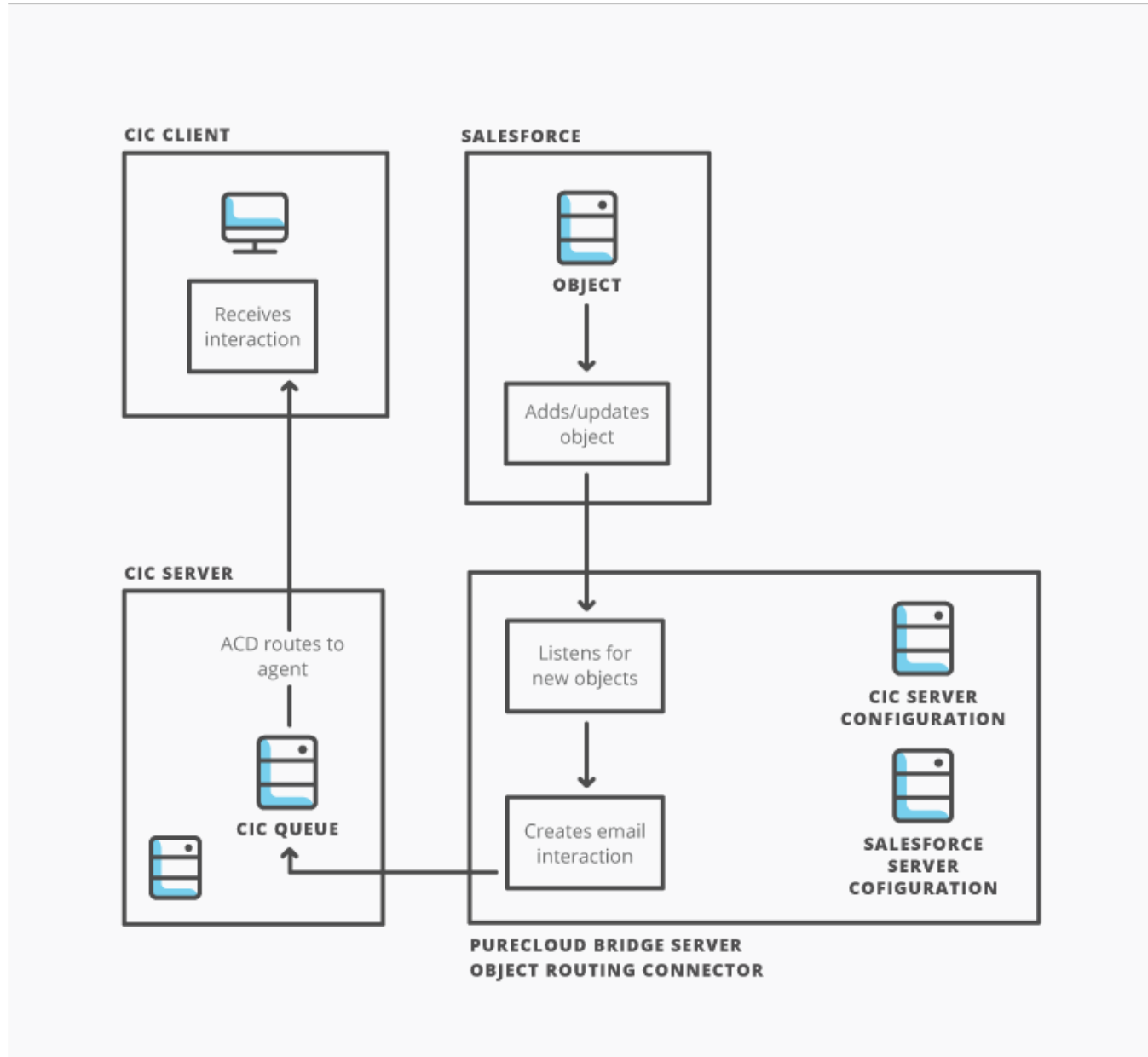

Connector pipeline for the Salesforce Object Routing Connector

# Networking components of the Salesforce Object Routing Connector for CIC

The following diagram shows which ports are needed for outbound access from the Bridge Server and the connector to Genesys Cloud, CIC, and Salesforce.

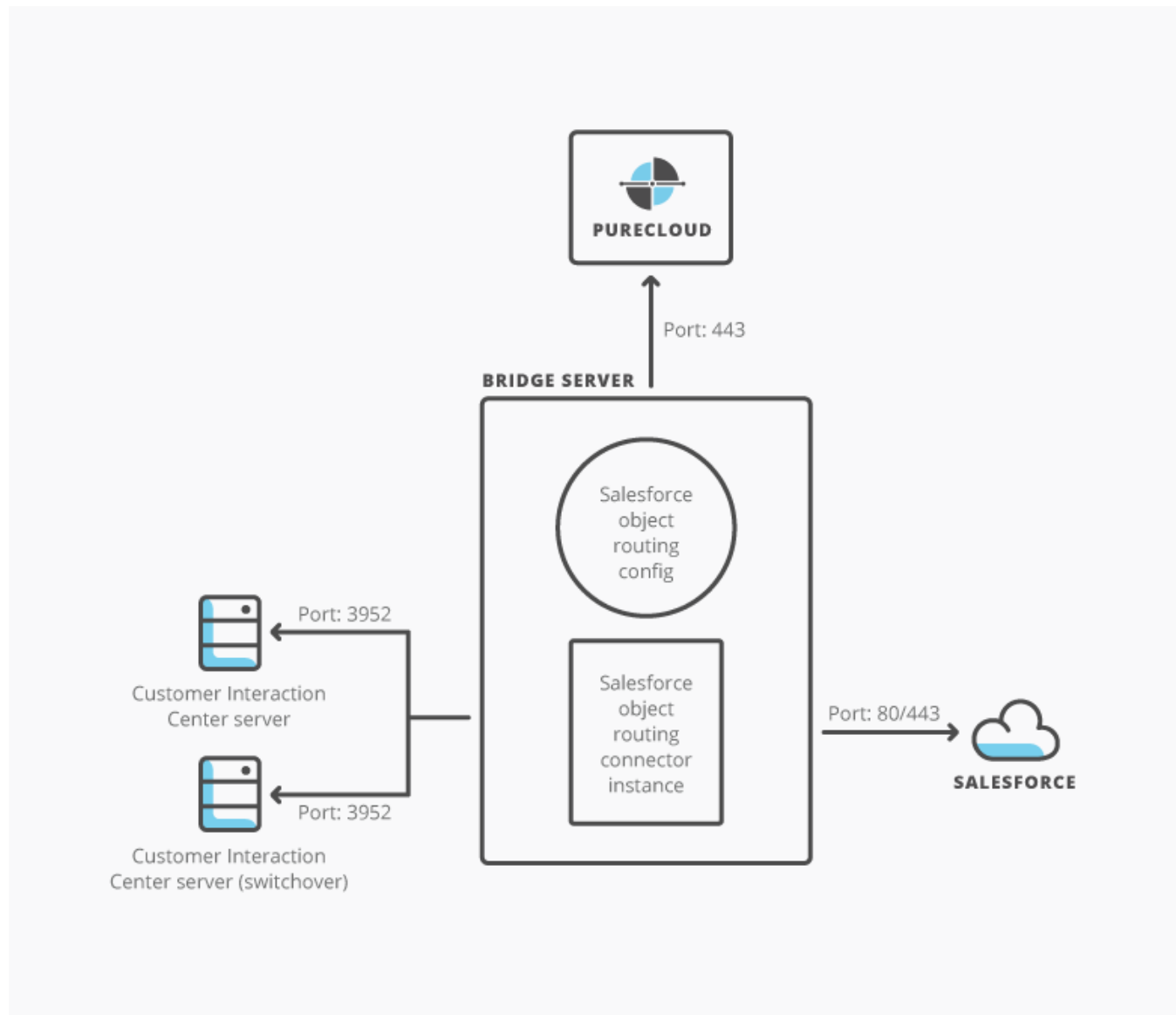

Networking components of the Salesforce Object Routing Connector



## Access a purchased connector

**Notice:** The Salesforce Object Routing Server is a replacement for the Salesforce Object Routing Connector. It eliminates the need for the PureCloud Bridge Server. Genesys will not support the PureCloud Bridge Server after January 1, 2021. To use the new Salesforce Object Routing Server, customers must use CIC 2018 R4 or a later release. For more information, see the [Salesforce Object Routing Server help](#).

To access the connector:

1. Follow the instructions in an older version of the documentation, [PureCloud for CIC Administrators Guide](#), to install the Bridge Server
2. Open a Genesys Cloud support ticket to request the activation of the connector for the Genesys Cloud organization. Include the email address and company name used for the Genesys Cloud organization.
3. Genesys Cloud Product Management will enable the purchased connector.
4. Begin setting up the connector in Genesys Cloud.

## Access a purchased connector

**Notice:** The Salesforce Object Routing Server is a replacement for the Salesforce Object Routing Connector. It eliminates the need for the PureCloud Bridge Server. Genesys will not support the PureCloud Bridge Server after January 1, 2021. To use the new Salesforce Object Routing Server, customers must use CIC 2018 R4 or a later release. For more information, see the [Salesforce Object Routing Server help](#).

To access the connector:

1. Follow the instructions in an older version of the documentation, [PureCloud for CIC Administrators Guide](#), to install the Bridge Server
2. Open a Genesys Cloud support ticket to request the activation of the connector for the Genesys Cloud organization. Include the email address and company name used for the Genesys Cloud organization.
3. Genesys Cloud Product Management will enable the purchased connector.
4. Begin setting up the connector in Genesys Cloud.

## Requirements for the Salesforce Object Routing Connector

**Prerequisite:** Before setup, purchase the connector and then follow the [steps to access it](#) (login required).

---

### PureCloud Bridge

- a PureCloud organization with a Bridge Server
- an instance of the connector configured for that Bridge Server
- login credentials set in the connector configuration
- all non-optional fields filled out in the connector configuration

**Note:** The year and release in the connector name indicates the minimum supported version of the CIC server. For example, a connector with 2015R2 in the name requires a CIC server that is 2015R2 or newer.

---

### CIC

- a running Customer Interaction Center (CIC) server
- a user with rights to:
  - View, Modify, Monitor, & Search for all Workgroup Queues
  - View, Modify, Monitor, & Search for all Station Queues
  - View, Modify, Monitor, & Search for all Line Queues
  - View, Modify, Monitor, & Search for all User Queues
  - View access for all Workgroups

**NOTE:** Standard CIC agents do not need special permissions to use the Salesforce Object Routing Connector.

- Use *this user* for ICAdminUser in the connector configuration.

---

### Salesforce

- Email-to-Case enabled in your Salesforce organization  
Under Build in Salesforce, select **Customize > Cases > Email-to-Case**.
- a user with administrator rights in Salesforce who:
  - can access the cases that the queue owns
  - use the API
  - has appropriate access to [PushTopics](#)Use this user for SalesforceUser in the connector configuration.
- agents need:
  - access to cases
  - to be members in a queue
  - a Salesforce integration client ([CIC for Salesforce](#))

**Note:** Salesforce agents can use the standard (default) user profile in Salesforce.

---

## Set up the Salesforce Object Routing Connector

### PureCloud Bridge items

1. [Install the PureCloud Bridge Server](#).
2. [Add a Salesforce Object Routing Connector](#).
3. [Configure the Salesforce Object Routing Connector](#).

### Salesforce-side items

1. [Install the managed package](#).
2. [Install the Interactions Routing Queues tab](#).
3. [Add queues to monitor](#).
4. [Add skills-based routing \(optional\)](#).

### CIC-side items

1. [Install the handler](#).
2. [Configure redundancy for a switchover event](#)

## Set up the Salesforce Object Routing Connector

### PureCloud Bridge items

1. [Install the PureCloud Bridge Server.](#)
2. [Add a Salesforce Object Routing Connector.](#)
3. [Configure the Salesforce Object Routing Connector.](#)

### Salesforce-side items

1. [Install the managed package.](#)
2. [Install the Interactions Routing Queues tab.](#)
3. [Add queues to monitor.](#)
4. [Add skills-based routing \(optional\).](#)

### CIC-side items

1. [Install the handler.](#)
2. [Configure redundancy for a switchover event](#)

## Install the Bridge Server

Install the Bridge Server so you can begin adding connectors for various data systems.

### Prerequisites:

- Machine (virtual machine recommended) for running the Bridge Server (see [PureCloud Bridge Server specifications](#)).
- Plan for handling connector credentials (Active Directory, Microsoft Exchange, and SharePoint integrations only)
- Plan for fault tolerance (know how many Bridge Servers you will install)
- If you plan to configure the Bridge Server and connectors behind a web proxy, complete the [proxy server configuration](#) before you install the Bridge Server.
- Make sure to apply all critical and important Windows updates before you install the Bridge Server.

### Procedure:

1. Click **Admin**.
2. Under Integrations, click **Bridge**.
3. Click the **Servers** tab, then click **Add Server**.

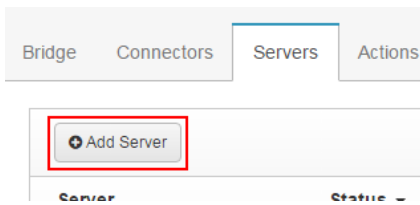

4. Enter a name and optional description, then click **Save**.

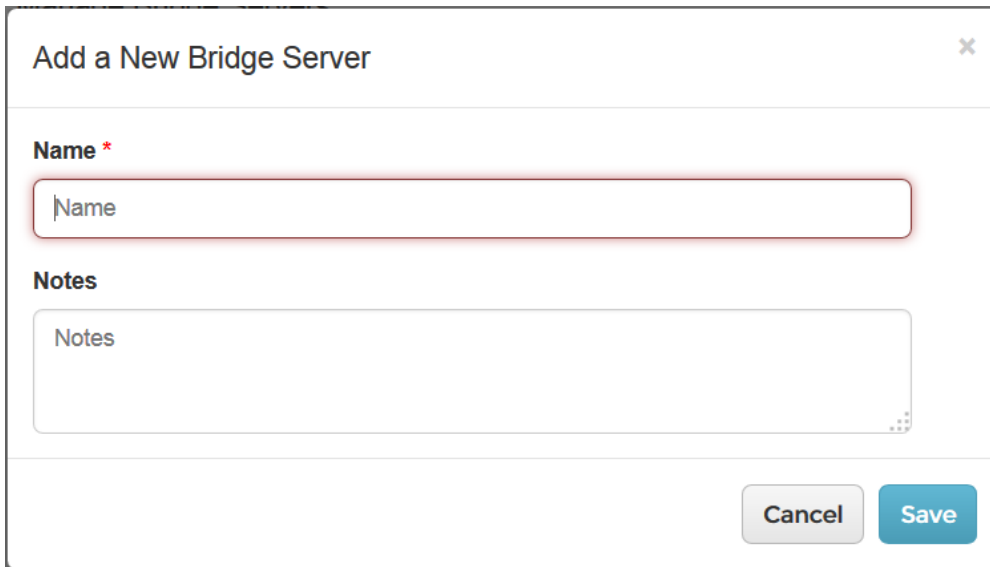
A screenshot of the 'Add a New Bridge Server' dialog box. The dialog has a title bar with a close button. Below the title bar, there are two input fields: 'Name \*' and 'Notes'. The 'Name \*' field is highlighted with a red border. At the bottom right of the dialog, there are two buttons: 'Cancel' and 'Save'.

5. Click **Server Installer** to download the Bridge Server executable.

## My New Bridge Server Details

Manage Servers / Server Details

← Back to servers

Status: offline

Last Started:

Initially Paired:

Contract Version:

Server Version:

Server Installer

Logs

Memory dumps

6. Under Pairing Token, click **Generate token**.

Pairing Token

Generate token

7. Copy the pairing token that appears to your clipboard or a text file.

Pairing Token

Generate token

84e6cce49140428c9c2062d76154c07516088f8bf4cc0c338c23b3cf1a6d2479

Copy

Search

8. Run the Bridge Server executable to start the installation wizard. Follow the prompts.
- Select a destination folder.
  - Select your Amazon Web Services region.
  - Paste the token into the Token field.
  - If you are using a [proxy server](#), type the proxy address in the Proxy Server field.
  - Select a service account based on your plan for handling the [Bridge credentials](#):
    - If the connectors will receive credentials from the cloud through the Network Service, accept the default.
    - If the connectors will receive credentials from the Bridge Server domain account, type the account credentials. Make sure that the account credentials include the domain name before the user name (domain\username).
  - Click **Install**.
9. If you plan to install multiple instances of the Bridge Server for fault tolerance, repeat the previous steps to install the Bridge Server on other machines.

**Tip:** You can [upgrade a Bridge Server](#) when a message on the Servers tab of the Bridge page indicates that a new version of the server is available.

## Add a Salesforce Object Routing Connector

**Note:** The year and release in the connector name indicates the minimum supported version of the CIC server. For example, a connector with 2015R2 in the name requires a CIC server that is 2015R2 or newer.

**Prerequisite:** Before setup, purchase the connector and then follow the [steps to access it](#) (login required).

To add a new connector group:

1. Click **Admin**.
2. Under Integrations, click **Bridge**.
3. Click the **Connectors** tab.
4. Click **Add**. A pop-up window appears.

### Add a new Connector ✕

---

**Name**

**Description**

---

**Choose a Plugin \***

⌵

**Publisher**  
inin

**Name**  
salesforcequeue-cic2015r2

**Description**  
This connector automates the process of routing cases from Salesforce to CIC's ACD engine. The ACD engine intelligently queues these cases based on predetermined criteria.

**Available Platforms**  
win-x64: v15.2.0.116 (latest)

**Platform \***  ⌵

**Version \***  ⌵

---

- a. Enter a name.  
The name must not contain any spaces but can include hyphens. This name appears as the Group Name on the Manage Connectors page.  
Use unique names. Unique names differentiate multiple connector groups of the same connector type from one another. For example, if you create two connector groups for the Salesforce Object Routing Connector, name them SalesforceORGroup1 and SalesforceORGroup2.
  - b. Choose the connector you want from the list provided.
  - c. Choose the Platform and Version.  
By default, the latest version is selected.
5. Click **Save**.

**Note:** Upgrades to Genesys Cloud and its connectors occur regularly. You can easily [upgrade an existing version](#) of the Salesforce Object Routing Connector.

## Configure the Salesforce Object Routing Connector

To use the Salesforce Object Routing Connector, add configuration properties, CIC and Salesforce credentials, and instances of the connector on the Connector Details page.

**Note:** Any configuration change requires a connector restart.

1. [Access the Connector Details page.](#)
2. [Add configuration properties.](#)
3. [Add CIC credentials.](#)
4. [Add Salesforce credentials.](#)
5. [Add a connector instance.](#)

## Configure the Salesforce Object Routing Connector

To use the Salesforce Object Routing Connector, add configuration properties, CIC and Salesforce credentials, and instances of the connector on the Connector Details page.

**Note:** Any configuration change requires a connector restart.

1. [Access the Connector Details page.](#)
2. [Add configuration properties.](#)
3. [Add CIC credentials.](#)
4. [Add Salesforce credentials.](#)
5. [Add a connector instance.](#)



## Access the Connector Details page

To use the Salesforce Object Routing Connector, add configuration properties, CIC and Salesforce credentials, and instances of the connector on the Connector Details page.

**Note:** Any configuration change requires a connector restart.

To access the Connector Details page:

1. Click **Admin**.
2. Under Integrations, click **Bridge**.
3. Click the **Connectors** tab.
4. Click an existing connector Group Name.  
The Connector Details page appears.

## Configure the Salesforce Object Routing Connector

To use the Salesforce Object Routing Connector, add configuration properties, CIC and Salesforce credentials, and instances of the connector on the Connector Details page.

**Note:** Any configuration change requires a connector restart.

1. [Access the Connector Details page](#).
2. [Add configuration properties](#).
3. [Add CIC credentials](#).
4. [Add Salesforce credentials](#).
5. [Add a connector instance](#).

## Add Configuration properties

To add configuration properties for the Salesforce Object Routing Connector:

1. Go to the Configuration section on the Connector Details page.
2. Add values for the following properties:
  - PluginName**—the unique name (for example, salesforcequeue) given to the log file created for this connector.  
**Note:** When running multiple connector instances on the same Bridge Server, make sure that the value for PluginName is unique for each connector group. The value for PluginName distinguishes the log files of the connector groups from one another.
  - SalesforceUrl** (optional)—the Salesforce URL used to connect to the API. For a test organization, use https://test.salesforce.com. Otherwise, the service defaults to https://login.salesforce.com.
  - ICServerName**—the name of the CIC server that the connector connects to.
  - EnableAutoDisconnectOnReply**—property that determines whether the interactions that were created as a result of the case are disconnected after an agent replies to a case. Set to **true** to enable this property, **false** to disable it. By default, this property is set to true.
3. Click **Save**.

## Add CIC Credentials

To add CIC credentials:

1. Go to the **Credentials** section on the Connector Details page.
2. Under CIC Credentials, click **Change**. A pop-up window appears. Add information for the following fields:
  - CIC Username**—login ID for the CIC server.
  - CIC Password**—password for the CIC server.
3. Click **Update**.

## Add Salesforce credentials

To add Salesforce credentials for the Salesforce Object Routing Connector:

1. Go to the **Credentials** section on the Connector Details page.
2. Under Salesforce Credentials, click **Change**. A pop-up window appears. Add information for the following fields:
  - Salesforce Username**—login ID for Salesforce. Use standard user profile as the minimum profile type.
  - Salesforce Password**—password for the Salesforce login ID.
  - Salesforce Security Token**—API token generated for the Salesforce org, which resembles AS4DFA9SasdJas2Hlasd1asdf.
3. Click **Update**.

## Add a connector instance

1. In the Connector Details tab, click **Add Instance** in the Instances section.
2. Click **Set Server** to open the Set Server window.
3. Select a Bridge Server and click **Save**.
4. Click the Enabled button to **ON**, and then click **Yes** in the Enable Connector Instance window.
5. Click the **Start** button under Control to turn on the connector.
6. To create more instances, repeat these steps. If you installed more than one instance of the Bridge Server for fault tolerance, add extra instances of the connector.

## Install the managed package for the Salesforce Object Routing Connector

The managed package contains all of the information needed for the Salesforce Object Routing Connector: the trigger, the custom object created from the trigger, and the PushTopic.

Download the managed package from Salesforce for a [production environment](#) or a [test environment](#). Follow the on-screen instructions for installation.

## Install the Interaction Routing Queues tab for the Salesforce Object Routing Connector

The Interaction Routing Queues tab allows you to tell the trigger which Salesforce queue names to monitor.

**Note:** For an interaction to be created from a case and routed to a queue, the case must go to a Salesforce queue specified on the Interaction Routing Queues page.

To add the Interaction Routing Queues tab:

1. In the left navigation pane under Build, select **Create > Tabs**.
2. In the Custom Object Tabs section, click **New**.
3. In the Object pulldown menu, select **Interaction Routing Queues**.
4. In the Tab Style pulldown menu, select any style.
5. In the Description text box, enter **Configure which queues to monitor for events**.  
The following steps assume the use of the default settings. Change the standard Salesforce configuration options before clicking **Next** or **Save**.
6. Click **Next**.
7. Click **Next**.
8. Click **Save**.

Once installed, a tab for the Interaction Routing Queues page appears in the top navigation bar in Salesforce.

## Add queues to monitor for the Salesforce Object Routing Connector

After you have installed the Interaction Routing Queues tab, map Salesforce queue names to CIC workgroup names. To map names, add Salesforce queue names and CIC workgroup names to the Interaction Routing Queues tab. The Salesforce Object Routing Connector monitors these Salesforce queues for cases and then routes the cases to these CIC workgroups.

**Note:** When using two Salesforce organizations, each organization must use different queue names in Salesforce and different workgroup names in CIC. Also, CIC workgroup members cannot belong to both organizations.

To add Salesforce queue names and CIC workgroup names in Salesforce:

1. Click **Interaction Routing Queues**.
2. Click **New**.
3. In the Salesforce Queue Name text box, add the [name of an existing Salesforce queue](#). The name of the queue input in the Salesforce Queue Name text box must match the name of an existing queue in Salesforce. The matching is case-sensitive.
4. In the CIC Workgroup Name text box, add the name of an existing CIC workgroup.  
The name of the workgroup input in the CIC Workgroup Name text box must match the name of an existing workgroup in CIC. The matching is case-sensitive.  
**Note:** Specify the workgroup on the CIC server as an ACD workgroup so that cases are routed based on certain criteria such as the agents' availability or skills. Also, configure the workgroup so that members in the workgroup are able to accept email interactions.
5. Leave the QueueID text box blank.  
The QueueID text box automatically populates with the ID of the Salesforce Queue Name when you click Save.
6. Click **Save**.

## Add skills-based routing for the Salesforce Object Routing Connector

The connector can route messages with designated required skills (for example, language or product knowledge). Agents in the workgroup who have the skills then receive these messages.

**Note:** Interactions route to agents with the designated skill regardless of proficiency or desire to use.

To set up skills-based routing:

1. Ensure that at a minimum your managed package is version 1.7.
2. Ensure that your handler is the latest version.
3. Check that the skills you want to use to route messages are set and assigned to users in Interaction Administrator.
4. Set the custom case field (ObjectRouting\_\_Skills\_\_c) in Salesforce during case creation. You can set the custom case field through the Salesforce API, through a before insert Salesforce trigger, or through other means. When setting field values:
  - o Match the skill names used in Interaction Administrator.
  - o Do not begin names with spaces.
  - o Separate multiple skills with semicolons. Do not use the pipe | delimiter.
  - o Limit skill names (including semicolons) to a total of 255 characters.

## Install the Salesforce Interaction Creator handler

To install the Salesforce Interaction Creator handler, [download](#) the handler file (zipped .ihd file) and publish it to the CIC server.

[SalesForce Object Routing Connector Help](#)

## Configure Redundancy for a Switchover Event

The Salesforce Object Routing Connector does not re-route lost interactions after a switchover event. This functionality is achieved through Interaction Recovery Service (IRS) and must be in place for email interactions. To enable IRS for email interactions, see [Recovery of email interactions](#) in the Automated Switchover Technical Reference.

[Copyright and trademark](#)

## Troubleshoot the Salesforce Object Routing Connector

- [Connector log files](#)
- [Server log files](#)
- [Bridge Server outage](#)
- [CIC server switchover](#)
- [Connector failed to start](#)
- [No interaction is routed](#)
- [Email interactions stop routing](#)
- [Unable to connect to the CIC server](#)
- [Unable to connect to the Salesforce server](#)
- [Push notifications stop working after sandbox refresh](#)

**Note:** See also the [PureConnect for Salesforce help](#) and the [Troubleshooting](#) section in the Salesforce Integration Administrator's Guide.

### Connector log files

The connector includes standard log files that record all events that have occurred in the execution of the programs. These files allow for tracking and diagnosis.

There are two types of connector log files:

- **inbridgehost\_{X}**: these log files are created when the Bridge Server loads the connector.
- **{connector group name}\_{X}.inlog**: these log files include both traces from connector and configuration loading, and any traces logged by the connector. These log files are created every day and each time the connector is restarted.

For copies of these log files:

1. Go to the Connector Details page.
  - a. Click **Admin**.
  - b. Under Integrations, click **Bridge**.
  - c. Click the **Connectors** tab.
  - d. Click the connector whose log files you want to view.
2. In the Instances section, click **Logs**.
3. Click **Request connector logs**.
4. Click a file to download. Both types of connector log files are included in the downloaded zip file.

### Server log files

The Bridge Server includes its own logging system for logging information about the internals of the server. These log files contain low-level process details that can describe any problems with starting the server as a whole or with receiving messages. For example, if the Windows processes of the server do not start or there are no relevant traces in the connector log files, check the Bridge Server log files.

There are three types of server log files:

- **inbridgeprocesslauncher.ininlog**: these log files record information about Bridge Server processes, such as crashes and restarts.
- **inbridgeserver\_{X}.ininlog**: these log files include information about the management of the connectors and their processes.
- **inbridgeservices\_{X}.ininlog**: these log files include information about communication between the Bridge Server and Amazon Web Services.

For copies of these log files:

1. Go to the Server Details page.
    - a. Click **Admin**.
    - b. Under Integrations, click **Bridge**.
    - c. Click the **Servers** tab.
    - d. Click the server whose log files you want to view.
  2. Click **Logs**.
  3. Click **Request server logs**.
  4. Click a file to download.
- 

## Bridge Server outage

When the connector or Bridge Server goes down, no data is lost. The next time the connector starts, the connector processes any updates that were left unprocessed due to the outage.

---

## CIC server switchover

A CIC server switchover requires having two CIC servers installed: one as the primary CIC server and another as the backup CIC server. When a CIC switchover occurs, the primary CIC server goes down and the backup CIC server becomes the new primary CIC server. The Bridge connector then creates a connection to the new primary CIC server.

---

## Connector failed to start

### Problem

The connector failed to start.

### Causes

The connector can fail to start for the following reasons:

- The Salesforce user permissions are incorrect.
- The Salesforce credentials in the connector configuration are incorrect.
- The CIC credentials in the connector configurations are incorrect.
- Some other unspecified error occurred.

### Solutions

- Confirm that the requirements for the [Salesforce user](#) with administrator rights have been met.
  - Confirm the [Salesforce credentials](#) in the connector configuration.
  - Confirm the [CIC credentials](#) in the connector configuration.
  - Check the connector log files for information about errors.
- 

## No interaction is routed

### Problem

A new object is created in Salesforce, but no interaction appears in the CIC queue.

### Causes

This issue can stem from any number of problems in any of the components or configurations that the connector requires.

- Email-to-case in Salesforce is not assigned to go to the user or queue set in your Interaction Routing Queues tab.
- No agent in queue has the skill assigned to the interaction.
- >An interaction for the object already exists.
  - If an interaction exists and is active, a new interaction is not created.

### Solutions

- Confirm that the settings in Case Assignment Rule and the Interaction Routing Queues tab in Salesforce go to the same user or queue.
  - Check the ACD Wait Reason in IC Business Manager.
    - The ACD Wait Reason column on the Agent or Workgroup Queue states if there are no available agents with the skill. If no available agents have the skill, then the interaction is not routed.
  - Confirm that an interaction exists.
    - Check the Salesforcequeue log file for the following note-level trace. The default location for this file is C:\Program Files\Interactive Intelligence\Bridge Server\logs.
    - An existing interaction was found related to object, no new interactions will be created for this object, object ID: (...)
  - If an interaction does not exist, narrow down the reason for the issue.
    1. Check the Observer log file on the connector configuration page for errors or warnings.
    2. Check the server-generated log file on the connector configuration page for the connector for errors or warnings.
    3. Check the individual connector log files in >C:\Program Files\Interactive Intelligence\Bridge Server\logs.
      - a. Confirm that a log file exists with the connector's name as the file name.
      - b. Look for any error or warning messages that indicate a problem.
      - c. Confirm that the object was detected. For example, look for an entry in the Salesforcequeue log file that is similar to the following: "PollingAgent.Poll : Received a polling event".
      - d. Confirm that the object data looks correct. For example, look for an entry in the Salesforcequeue log file that is similar to the following. This entry also shows the payload that represents the object.

```
"PollingAgent.HandlePollingResult : The request was successful".
```
    - e. Confirm that an attempt was made to create the interaction from the object.

```
"IceLibInteractionManager.CreateEmailInteraction : Creating email interaction with sender".
```
    - f. Confirm that the interaction was successfully created.

```
"IceLibInteractionManager.CreateEmailInteraction : Email interaction (...) was successfully created."
```
    - g. Confirm that the interaction was transferred to a workgroup.

```
"IceLibInteractionManager.CreateEmailInteraction : Transferring email interaction (...) to target workgroup (...)", and then look for "IceLibInteractionManager.CreateEmailInteraction : Email Interaction ... was successfully transferred."
```
    - h. Finally, confirm that the connector received a notification that the interaction was successfully created with an ID.

```
"SalesforceQueuePlugin.OnMessageReceived : Created Interaction with Id: 100154078860131210".
```
-

## Email interactions stop routing

### Problem

Push Notifications for the Salesforce Console do not work after deploying the Salesforce Console app in the target org or in a refreshed sandbox.

### Causes

The cause of emails failure is due to the removal of Push Topics. Push notifications are part of Salesforce streaming API which helps in subscribing the ININ Object Routing Queue table to SORS.

### Solution

You can recreate the Push Topic following these steps:

1. In the **Workbench** application, click **queries** and select **Streaming Push Topics** option from the list.

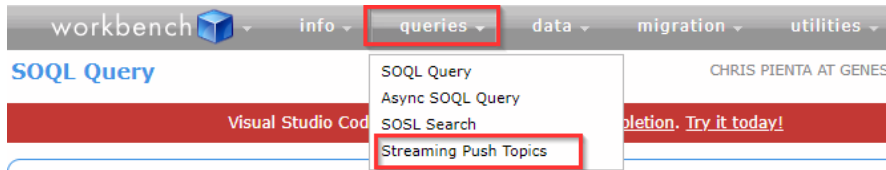

2. In the **Streaming Push Topics** page, select **ININ\_ObjectRouting** option from the **Push Topic** list.
3. To display object **Name**, **API Version**, and **Query** boxes, click **Details**.
4. Click **Delete**.

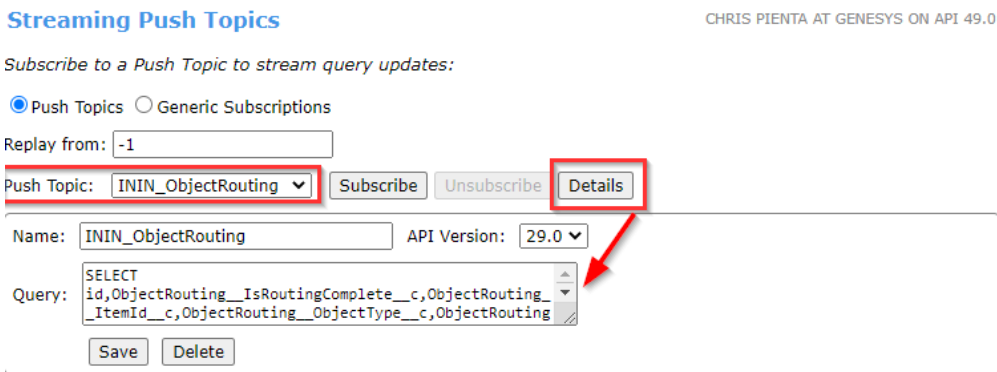

>>>> ORIGINAL //eic/2021r1\_systest/products/documentation/source/SalesforceConnector/Troubleshoot\_the\_Salesforce\_Object\_Routing\_Connector.htm#2

2. In the **Streaming Push Topics** page, select **ININ\_ObjectRouting** option from the **Push Topic** list.
3. To display object **Name**, **API Version**, and **Query** boxes, click **Details**.
4. Click **Delete**.

### Streaming Push Topics

CHRIS PIENTA AT GENESYS ON API 49.0

Subscribe to a Push Topic to stream query updates:

Push Topics  Generic Subscriptions

Replay from: -1

Push Topic: ININ\_ObjectRouting

Name: ININ\_ObjectRouting API Version: 29.0

Query: SELECT id, ObjectRouting\_IsRoutingComplete\_\_c, ObjectRouting\_ItemId\_\_c, ObjectRouting\_ObjectType\_\_c, ObjectRouting...

5. Click  next to the user name and select the **Developer Console** from the list.

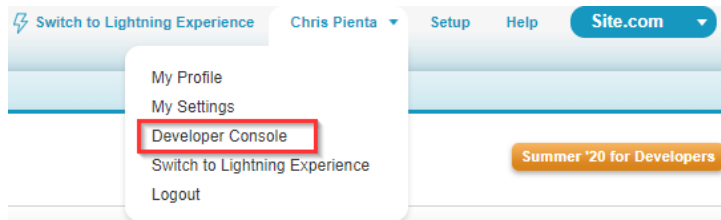

6. Select the **Open Execute Anonymous Window** from the **Debug** list.

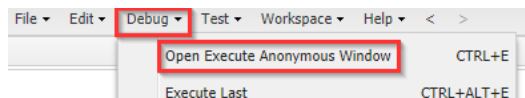

7. In the **Open Execute Anonymous Window**, run the below script.

```
PushTopic ==== THEIRS
//eic/2021rl_systest/products/documentation/source/SalesforceConnector/Troubleshoot_the_Salesforce_Object_Routing_Connector.htm#3
```

- In the **Streaming Push Topics** page, select **ININ\_ObjectRouting** option from the **Push Topic** list.
- To display object **Name**, **API Version**, and **Query** boxes, click **Details**.
- Click **Delete**.

## Streaming Push Topics

CHRIS PIENTA AT GENESYS ON API 49.0

Subscribe to a Push Topic to stream query updates:

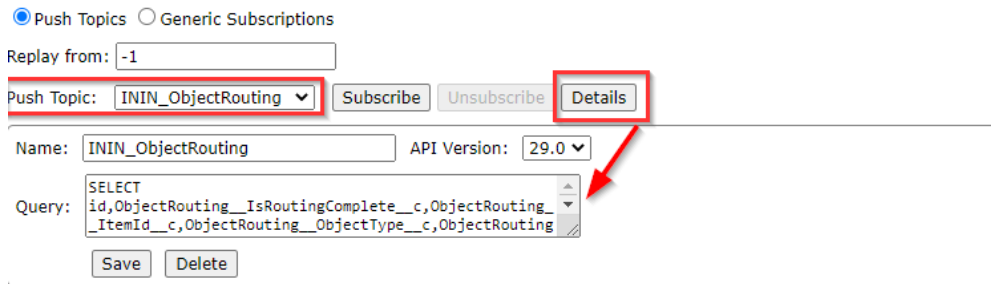

5. Click  next to the user name and select the **Developer Console** from the list.

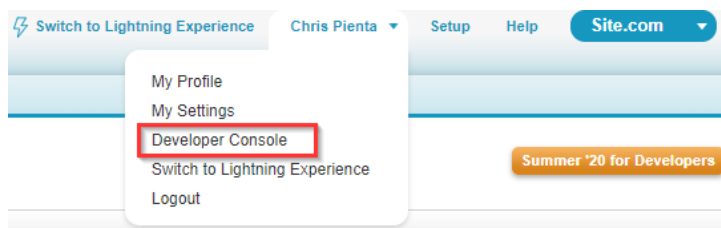

6. Select the **Open Execute Anonymous Window** from the **Debug** list.

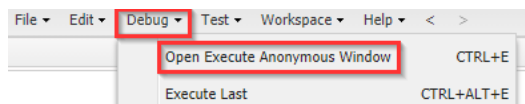

7. In the **Open Execute Anonymous Window**, run the below script.

```
PushTopic ==== YOURS //inf-
5cd0246xjc_eic_main_systest/products/documentation/source/SalesforceConnector/Troubleshoot_the_Salesforce_Object_Routing_Connector.htm
```

5. Click  next to the user name and select the **Developer Console** from the list.

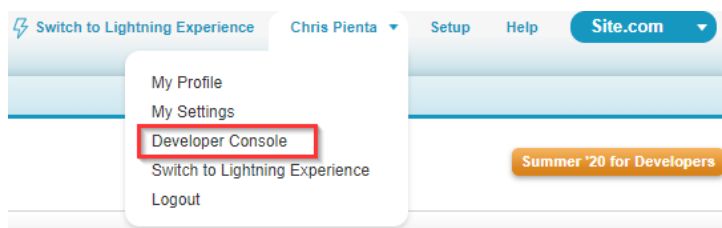

6. Select the **Open Execute Anonymous Window** from the **Debug** list.

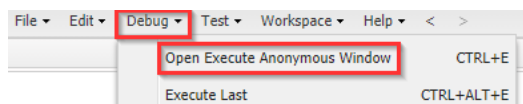

7. In the **Open Execute Anonymous Window**, run the below script.

```
PushTopic <<<< pushTopic = new PushTopic();
pushTopic.Name = 'ININ_ObjectRouting';
>>>> ORIGINAL //eic/2021rl_systest/products/documentation/source/SalesforceConnector/Troubleshoot_the_Salesforce_Object_Routing_Connector.htm#2
pushTopic.Query = 'SELECT
id,ObjectRouting_IsRoutingCompletec,ObjectRoutingItemIdc,ObjectRoutingObjectTypec,ObjectRoutingQueueNamec,ObjectRoutingSearchableIdc,ObjectRout
ObjectRoutingInteractionTypec, ObjectRoutingAdditionalAttributesc, ObjectRoutingSkillsc FROM ObjectRoutingININ_Object_Routing_Queue_c';
pushTopic.ApiVersion ==== THEIRS
//eic/2021rl_systest/products/documentation/source/SalesforceConnector/Troubleshoot_the_Salesforce_Object_Routing_Connector.htm#3
pushTopic.Query = 'SELECT
id,ObjectRouting_IsRoutingComplete_c,ObjectRouting_ItemId_c,ObjectRouting_ObjectType_c,ObjectRouting_QueueName_c,ObjectRouting_Searcha
ObjectRouting_InteractionType_c, ObjectRouting_AdditionalAttributes_c, ObjectRouting_Skills_c FROM
ObjectRouting_ININ_Object_Routing_Queue_c';
pushTopic.ApiVersion ==== YOURS //inf-
5cd0246xjc_eic_main_systest/products/documentation/source/SalesforceConnector/Troubleshoot_the_Salesforce_Object_Routing_Connector.htm
pushTopic.Query ='SELECT
id,ObjectRouting_IsRoutingCompletec,ObjectRoutingItemIdc,ObjectRoutingObjectTypec,ObjectRoutingQueueNamec,ObjectRoutingSearchableIdc,ObjectRout
ObjectRoutingInteractionTypec, ObjectRoutingAdditionalAttributesc, ObjectRoutingSkillsc FROM ObjectRoutingININ_Object_Routing_Queue_c';
pushTopic.ApiVersion <<<< = 29.0;
```

```
pushTopic.NotifyForOperationCreate = true;
pushTopic.NotifyForOperationUpdate = true;
pushTopic.NotifyForOperationUndelete = true;
pushTopic.NotifyForOperationDelete = false;
pushTopic.NotifyForFields = 'Referenced';
insert pushTopic;
```

#### 8. Restart the SORS.

---

## Unable to connect to the CIC server

### Problem

The connector is unable to connect to the CIC server.

### Causes

This issue is typically due to invalid or missing server credentials in the connector configuration. However, this issue can also be due to security settings blocking network traffic or to an outage of the CIC server.

### Solutions

- Confirm the connector configuration settings.
  - **ICServerName**: name of the CIC server that the connector connects to
  - **CIC Username**: login ID for the CIC server
  - **CIC Password**: password for the CIC server
- If the issue is not due to incorrect configuration settings, confirm that the connection to the CIC server was successful. Check the Salesforcequeue log file for the following configurations. The default location for this file is C:\Program Files\Interactive Intelligence\Bridge Server\logs.

```
ICConnectionManager.SessionConnectionStateChanged : CIC connection state has changed to 'Attempting'. Message: 'Connecting to Interaction Center.'. Reason: 'LogOn'.
ICConnectionManager.SessionConnectionStateChanged : CIC connection state has changed to 'Up'. Message: 'Successfully connected to Interaction Center.'. Reason: 'LogOn'.
```

If these messages exist, the connection was successful.

If they do not exist, the connection was not successful. Check the security settings and [firewall permissions](#) for your network connection.

---

## Unable to connect to the Salesforce server

### Problem

The connector is unable to connect to the Salesforce server.

### Causes

This issue is typically due to invalid or missing server credentials in the connector configuration. However, this issue can also be due to security settings blocking network traffic or to an outage of the Salesforce server.

### Solutions

- Confirm the connector configuration settings.
  - **Salesforce Username**: login ID for Salesforce  
Use the standard user profile as the minimum profile type.
  - **Salesforce Password**: password for the Salesforce login ID
  - **Salesforce Security Token**: API token generated for the Salesforce org, which resembles AS4DFA9SasJas2Hlasd1asdf.
- If the issue is not due to incorrect configurations, confirm that the connection to the connector was successful. Check the Interactive Intelligence log file for the following. The default location for this file is C:\Program Files\Interactive Intelligence\Bridge Server\logs.

```
SalesforceQueuePlugin.ConnectToSalesforce : Connecting to Salesforce User: [Salesforce administrator's user email address]
```

```
Connection.Connect : Attempting to connect to Salesforce with user:
```

```
Connection.Connect : Successfully connected to https://na15.salesforce.com/services/Soap/u/27.0/..., is password expired?False
```

If these messages exist, the connection was successful.

If they do not exist, the connection was not successful. Check the security settings and [firewall permissions](#) for your network connection.

---

## Push notification stop working after sandbox refresh

### Problem

Push Notifications for the Salesforce Console do not work in a target organization after deploying the Console app or in a refreshed sandbox.

### Causes

Push Notification Objects and Fields in a Console configuration are not copied when deploying a Console app or when refreshing a sandbox.

### Solutions

You can recreate the Push Notifications following these steps:

1. From **Setup**, enter **Apps** in the **Quick Find** box, then select **Apps**.
  2. Select the name of a Console App.
  3. Select **Select objects and fields for notifications** next to **Choose Push Notifications**.
  4. Click **Edit**, select the desired objects and fields, then click **Save**.
- 

## Troubleshoot the Salesforce Object Routing Connector

- [Connector log files](#)
  - [Server log files](#)
  - [Bridge Server outage](#)
  - [CIC server switchover](#)
  - [Connector failed to start](#)
-

- [No interaction is routed](#)
- [Email interactions stop routing](#)
- [Unable to connect to the CIC server](#)
- [Unable to connect to the Salesforce server](#)
- [Push notifications stop working after sandbox refresh](#)

**Note:** See also the [PureConnect for Salesforce help](#) and the [Troubleshooting](#) section in the Salesforce Integration Administrator's Guide.

## Connector log files

The connector includes standard log files that record all events that have occurred in the execution of the programs. These files allow for tracking and diagnosis.

There are two types of connector log files:

- **ininbridgehost\_{X}**: these log files are created when the Bridge Server loads the connector.
- **{connector group name}\_{X}.ininlog**: these log files include both traces from connector and configuration loading, and any traces logged by the connector. These log files are created every day and each time the connector is restarted.

For copies of these log files:

1. Go to the Connector Details page.
  - a. Click **Admin**.
  - b. Under Integrations, click **Bridge**.
  - c. Click the **Connectors** tab.
  - d. Click the connector whose log files you want to view.
2. In the Instances section, click **Logs**.
3. Click **Request connector logs**.
4. Click a file to download. Both types of connector log files are included in the downloaded zip file.

## Server log files

The Bridge Server includes its own logging system for logging information about the internals of the server. These log files contain low-level process details that can describe any problems with starting the server as a whole or with receiving messages. For example, if the Windows processes of the server do not start or there are no relevant traces in the connector log files, check the Bridge Server log files.

There are three types of server log files:

- **ininbridgeprocesslauncher.ininlog**: these log files record information about Bridge Server processes, such as crashes and restarts.
- **ininbridgeserver\_{X}.ininlog**: these log files include information about the management of the connectors and their processes.
- **ininbridgeservices\_{X}.ininlog**: these log files include information about communication between the Bridge Server and Amazon Web Services.

For copies of these log files:

1. Go to the Server Details page.
  - a. Click **Admin**.
  - b. Under Integrations, click **Bridge**.
  - c. Click the **Servers** tab.
  - d. Click the server whose log files you want to view.
2. Click **Logs**.
3. Click **Request server logs**.
4. Click a file to download.

## Bridge Server outage

When the connector or Bridge Server goes down, no data is lost. The next time the connector starts, the connector processes any updates that were left unprocessed due to the outage.

## CIC server switchover

A CIC server switchover requires having two CIC servers installed: one as the primary CIC server and another as the backup CIC server. When a CIC switchover occurs, the primary CIC server goes down and the backup CIC server becomes the new primary CIC server. The Bridge connector then creates a connection to the new primary CIC server.

## Connector failed to start

### Problem

The connector failed to start.

### Causes

The connector can fail to start for the following reasons:

- The Salesforce user permissions are incorrect.
- The Salesforce credentials in the connector configuration are incorrect.
- The CIC credentials in the connector configurations are incorrect.
- Some other unspecified error occurred.

### Solutions

- Confirm that the requirements for the [Salesforce user](#) with administrator rights have been met.
- Confirm the [Salesforce credentials](#) in the connector configuration.
- Confirm the [CIC credentials](#) in the connector configuration.
- Check the connector log files for information about errors.

## No interaction is routed

### Problem

A new object is created in Salesforce, but no interaction appears in the CIC queue.

### Causes

This issue can stem from any number of problems in any of the components or configurations that the connector requires.

- Email-to-case in Salesforce is not assigned to go to the user or queue set in your Interaction Routing Queues tab.

- No agent in queue has the skill assigned to the interaction.
- >An interaction for the object already exists.  
If an interaction exists and is active, a new interaction is not created.

## Solutions

- Confirm that the settings in Case Assignment Rule and the Interaction Routing Queues tab in Salesforce go to the same user or queue.
- Check the ACD Wait Reason in IC Business Manager.  
The ACD Wait Reason column on the Agent or Workgroup Queue states if there are no available agents with the skill. If no available agents have the skill, then the interaction is not routed.
- Confirm that an interaction exists.  
Check the Salesforcequeue log file for the following note-level trace. The default location for this file is C:\Program Files\Interactive Intelligence\Bridge Server\logs.  
An existing interaction was found related to object, no new interactions will be created for this object, object ID: (...)
- If an interaction does not exist, narrow down the reason for the issue.
  1. Check the Observer log file on the connector configuration page for errors or warnings.
  2. Check the server-generated log file on the connector configuration page for the connector for errors or warnings.
  3. Check the individual connector log files in >C:\Program Files\Interactive Intelligence\Bridge Server\logs.
    - a. Confirm that a log file exists with the connector's name as the file name.
    - b. Look for any error or warning messages that indicate a problem.
    - c. Confirm that the object was detected. For example, look for an entry in the Salesforcequeue log file that is similar to the following: "PollingAgent.Poll : Received a polling event".
    - d. Confirm that the object data looks correct. For example, look for an entry in the Salesforcequeue log file that is similar to the following. This entry also shows the payload that represents the object.  
"PollingAgent.HandlePollingResult : The request was successful".
    - e. Confirm that an attempt was made to create the interaction from the object.  
"IceLibInteractionManager.CreateEmailInteraction : Creating email interaction with sender".
    - f. Confirm that the interaction was successfully created.  
"IceLibInteractionManager.CreateEmailInteraction : Email interaction (...) was successfully created."
    - g. Confirm that the interaction was transferred to a workgroup.  
"IceLibInteractionManager.CreateEmailInteraction : Transferring email interaction (...) to target workgroup (...)", and then look for "IceLibInteractionManager.CreateEmailInteraction : Email Interaction ... was successfully transferred."
    - h. Finally, confirm that the connector received a notification that the interaction was successfully created with an ID.  
"SalesforceQueuePlugin.OnMessageReceived : Created Interaction with Id: 100154078860131210".

## Email interactions stop routing

### Problem

Push Notifications for the Salesforce Console do not work after deploying the Salesforce Console app in the target org or in a refreshed sandbox.

### Causes

The cause of emails failure is due to the removal of Push Topics. Push notifications are part of Salesforce streaming API which helps in subscribing the ININ Object Routing Queue table to SORS.

### Solution

You can recreate the Push Topic following these steps:

1. In the **Workbench** application, click **queries** and select **Streaming Push Topics** option from the list.

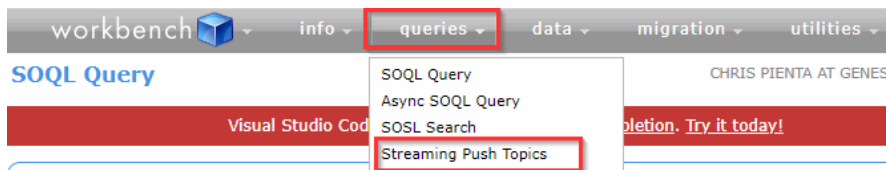

2. In the **Streaming Push Topics** page, select **ININ\_ObjectRouting** option from the **Push Topic** list.
3. To display object **Name**, **API Version**, and **Query** boxes, click **Details**.
4. Click **Delete**.

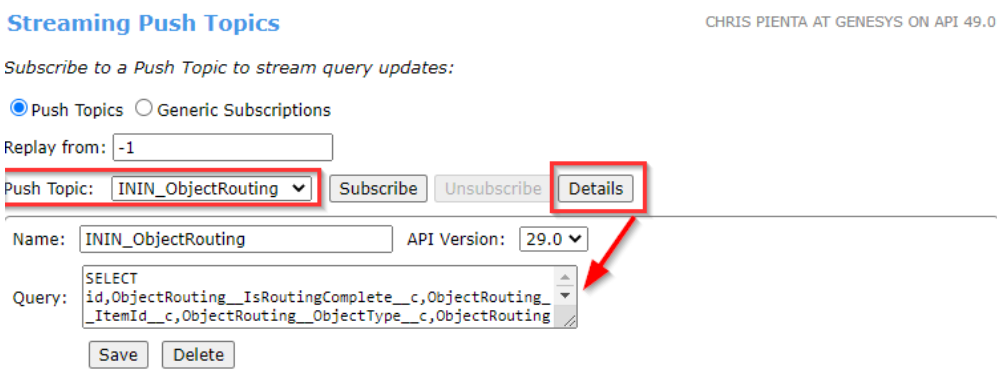

>>>> ORIGINAL //eic/2021r1\_systest/products/documentation/source/SalesforceConnector/Troubleshoot\_the\_Salesforce\_Object\_Routing\_Connector.htm#2

2. In the **Streaming Push Topics** page, select **ININ\_ObjectRouting** option from the **Push Topic** list.
3. To display object **Name**, **API Version**, and **Query** boxes, click **Details**.
4. Click **Delete**.



## Streaming Push Topics

CHRIS PIENTA AT GENESYS ON API 49.0

Subscribe to a Push Topic to stream query updates:

Push Topics  Generic Subscriptions

Replay from:

Push Topic:

Name:  API Version:

Query: 

```
SELECT
id,ObjectRouting_IsRoutingComplete__c,ObjectRouting_
ItemId__c,ObjectRouting_ObjectType__c,ObjectRouting
```

5. Click  next to the user name and select the **Developer Console** from the list.

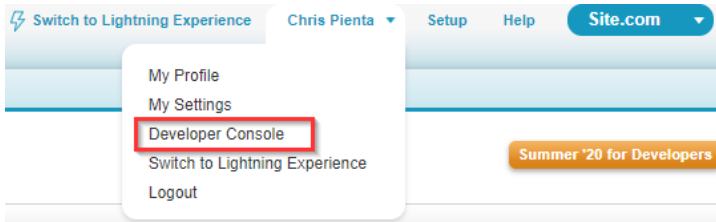

6. Select the **Open Execute Anonymous Window** from the **Debug** list.

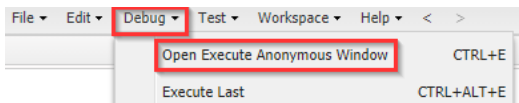

7. In the **Open Execute Anonymous Window**, run the below script.

```
PushTopic ==== THEIRS
//eic/2021r1_systest/products/documentation/source/SalesforceConnector/Troubleshoot_the_Salesforce_Object_Routing_Connector.htm#3
```

2. In the **Streaming Push Topics** page, select **ININ\_ObjectRouting** option from the **Push Topic** list.

3. To display object **Name**, **API Version**, and **Query** boxes, click **Details**.

4. Click **Delete**.

## Streaming Push Topics

CHRIS PIENTA AT GENESYS ON API 49.0

Subscribe to a Push Topic to stream query updates:

Push Topics  Generic Subscriptions

Replay from:

Push Topic:

Name:  API Version:

Query: 

```
SELECT
id,ObjectRouting_IsRoutingComplete__c,ObjectRouting_
ItemId__c,ObjectRouting_ObjectType__c,ObjectRouting
```

5. Click  next to the user name and select the **Developer Console** from the list.

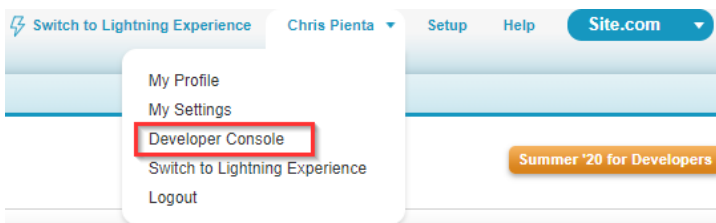

6. Select the **Open Execute Anonymous Window** from the **Debug** list.

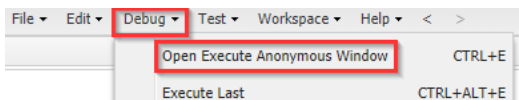

7. In the **Open Execute Anonymous Window**, run the below script.

```
PushTopic ==== YOURS //inf-
5cd0246xjc_eic_main_systest/products/documentation/source/SalesforceConnector/Troubleshoot_the_Salesforce_Object_Routing_Connector.htm
```

5. Click  next to the user name and select the **Developer Console** from the list.

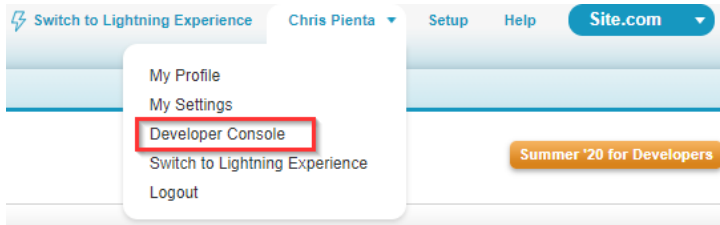

6. Select the **Open Execute Anonymous Window** from the **Debug** list.

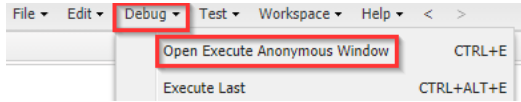

7. In the **Open Execute Anonymous Window**, run the below script.

```

PushTopic <<<< pushTopic = new PushTopic();
pushTopic.Name = 'ININ_ObjectRouting';
>>> ORIGINAL //eic/2021r1_systest/products/documentation/source/SalesforceConnector/Troubleshoot_the_Salesforce_Object_Routing_Connector.htm#2
pushTopic.Query = 'SELECT
id,ObjectRouting_IsRoutingCompletec,ObjectRoutingItemIdc,ObjectRoutingObjectTypec,ObjectRoutingQueueNamec,ObjectRoutingSearchableIDc,ObjectRout
ObjectRoutingInteractionTypec, ObjectRoutingAdditionalAttributesc, ObjectRoutingSkillsc FROM ObjectRoutingININ_Object_Routing_Queue_c';
pushTopic.ApiVersion ==== THEIRS
//eic/2021r1_systest/products/documentation/source/SalesforceConnector/Troubleshoot_the_Salesforce_Object_Routing_Connector.htm#3
pushTopic.Query = 'SELECT
id,ObjectRouting_IsRoutingComplete_c,ObjectRouting_ItemId_c,ObjectRouting_ObjectType_c,ObjectRouting_QueueName_c,ObjectRouting_Searcha
ObjectRouting_InteractionType_c, ObjectRouting_AdditionalAttributes_c, ObjectRouting_Skills_c FROM
ObjectRouting_ININ_Object_Routing_Queue_c';
pushTopic.ApiVersion ==== YOURS //inf-
5cd0246xjc_eic_main_systest/products/documentation/source/SalesforceConnector/Troubleshoot_the_Salesforce_Object_Routing_Connector.htm
pushTopic.Query ='SELECT
id,ObjectRouting_IsRoutingCompletec,ObjectRoutingItemIdc,ObjectRoutingObjectTypec,ObjectRoutingQueueNamec,ObjectRoutingSearchableIDc,ObjectRout
ObjectRoutingInteractionTypec, ObjectRoutingAdditionalAttributesc, ObjectRoutingSkillsc FROM ObjectRoutingININ_Object_Routing_Queue_c';
pushTopic.ApiVersion <<<< = 29.0;
pushTopic.NotifyForOperationCreate = true;
pushTopic.NotifyForOperationUpdate = true;
pushTopic.NotifyForOperationUndelete = true;
pushTopic.NotifyForOperationDelete = false;
pushTopic.NotifyForFields = 'Referenced';
insert pushTopic;

```

8. Restart the SORS.

## Unable to connect to the CIC server

### Problem

The connector is unable to connect to the CIC server.

### Causes

This issue is typically due to invalid or missing server credentials in the connector configuration. However, this issue can also be due to security settings blocking network traffic or to an outage of the CIC server.

### Solutions

- Confirm the connector configuration settings.
  - **ICServerName**: name of the CIC server that the connector connects to
  - **CIC Username**: login ID for the CIC server
  - **CIC Password**: password for the CIC server
- If the issue is not due to incorrect configuration settings, confirm that the connection to the CIC server was successful. Check the Salesforcequeue log file for the following configurations. The default location for this file is C:\Program Files\Interactive Intelligence\Bridge Server\logs.

```

ICCConnectionManager.SessionConnectionStateChanged : CIC connection state has changed to 'Attempting'. Message: 'Connecting to Interaction Center.'. Reason: 'LogOn'.
ICCConnectionManager.SessionConnectionStateChanged : CIC connection state has changed to 'Up'. Message: 'Successfully connected to Interaction Center.'. Reason: 'LogOn'.

```

If these messages exist, the connection was successful.

If they do not exist, the connection was not successful. Check the security settings and [firewall permissions](#) for your network connection.

## Unable to connect to the Salesforce server

### Problem

The connector is unable to connect to the Salesforce server.

### Causes

This issue is typically due to invalid or missing server credentials in the connector configuration. However, this issue can also be due to security settings blocking network traffic or to an outage of the Salesforce server.

### Solutions

- Confirm the connector configuration settings.
  - **Salesforce Username**: login ID for Salesforce
  - Use the standard user profile as the minimum profile type.

- **Salesforce Password:** password for the Salesforce login ID
- **Salesforce Security Token:** API token generated for the Salesforce org, which resembles AS4DFA9SasJas2Hlasd1asdf.
- If the issue is not due to incorrect configurations, confirm that the connection to the connector was successful. Check the Interactive Intelligence log file for the following. The default location for this file is C:\Program Files\Interactive Intelligence\Bridge Server\logs.

```
SalesforceQueuePlugin.ConnectToSalesforce : Connecting to Salesforce User: [Salesforce administrator's user email address]
```

```
Connection.Connect : Attempting to connect to Salesforce with user:
```

```
Connection.Connect : Successfully connected to https://na15.salesforce.com/services/Soap/u/27.0/..., is password expired?False
```

If these messages exist, the connection was successful.

If they do not exist, the connection was not successful. Check the security settings and [firewall permissions](#) for your network connection.

---

## Push notification stop working after sandbox refresh

### Problem

Push Notifications for the Salesforce Console do not work in a target organization after deploying the Console app or in a refreshed sandbox.

### Causes

Push Notification Objects and Fields in a Console configuration are not copied when deploying a Console app or when refreshing a sandbox.

### Solutions

You can recreate the Push Notifications following these steps:

1. From **Setup**, enter **Apps** in the **Quick Find** box, then select **Apps**.
2. Select the name of a Console App.
3. Select **Select objects and fields for notifications** next to **Choose Push Notifications**.
4. Click **Edit**, select the desired objects and fields, then click **Save**.

# Change log

Date	Changes
24-May-2017	Moved Salesforce Object Routing Connect documentation from the PureCloud Resource Center to the PureConnect Documentation Library.
08-September-2017	Rebranded documentation to Genesys terminology and standards.
14-December-2017	Updated Requirements for the Salesforce Object Routing Connector topic. In CIC section, added a user with rights to View access for All Workgroups.
09-January-2018	Updated Requirements for the Salesforce Object Routing Connector topic. Added a user with administrator rights in Salesforce who has appropriate access to PushTopics to the Salesforce section.
07-December-2018	Added September 18, 2018 and July 27, 2018 information to Release notes for the Salesforce Object Routing Connector topic.
18-March-2019	Created this change log.
02-April-2019	<p>Added to Release Notes: April 1, 2019, 15.2.0.369. Update to managed package (v1.8). This adds a new direct-to-queue option and fixes an routing issue where interactions were routed to the originating monitored queue after the case owner was changed to an unmonitored queue.</p> <p>Updated Release Note: October 26, 2015, 15.2.0.295. Added (v1.7) to Updated handler and managed package (v1.7).</p>
10-April-2019	In the Install the managed package for the Salesforce Object Routing Connector, updated the hyperlinks for production environment and test environment.
08-July-2019	Added new topic: Configure Redundancy for a Switchover Event. Added link to this new topic to the Set up the Salesforce Object Routing Connector topic.
12-July-2019	Added to Release Notes: 15.2.0.369, 12-July-2019, Update to managed package (v1.9). This update fixes a bug where interactions were not being created when comments were added to a case in Salesforce.
20-September-2019	In the Install the managed package for the Salesforce Object Routing Connector topic, changed links for production environment to <a href="https://login.salesforce.com/packaging/installPackage.apexp?p0=04t4A000000onEw">https://login.salesforce.com/packaging/installPackage.apexp?p0=04t4A000000onEw</a> and link for test environment to <a href="https://test.salesforce.com/packaging/installPackage.apexp?p0=04t4A000000onEw">https://test.salesforce.com/packaging/installPackage.apexp?p0=04t4A000000onEw</a> .
12-November-2019	Added note referring to the PureConnect for Salesforce help and the Troubleshooting section of the Salesforce Integration Administrator's Guide to the Troubleshoot the Salesforce Object Routing Connector topic.
15-January-2020	Updated Zip file for handler in the Install the handler for the Salesforce Object Routing Connector topic.
30-March-2020	Added Notice of Salesforce Object Routing Server to the About the Salesforce Object Routing Connector topic.
08-May-2020	Replaced links to <a href="http://inin.com">inin.com</a> with links to <a href="http://genesys.com">genesys.com</a> .
23-September-2020	Updated for Genesys Cloud rebranding.
09-October-2020	Renamed handler topic to Install the Salesforce Interaction Creator handler and rewrote description.