



420HD IP Phone

User's Guide

(for PureConnect)

The information contained herein is proprietary and confidential and cannot be disclosed or duplicated without the prior written consent of Genesys Telecommunications Laboratories, Inc.
Copyright © 2018 Genesys Telecommunications Laboratories, Inc. All rights reserved.

About Genesys

Genesys powers 25 billion of the world's best customer experiences each year. Our success comes from connecting employee and customer conversations on any channel, every day. Over 10,000 companies in 100+ countries trust our #1 customer experience platform to drive great business outcomes and create lasting relationships. Combining the best of technology and human ingenuity, we build solutions that mirror natural communication and work the way you think. Our industry-leading solutions foster true omnichannel engagement, performing equally well across all channels, on-premise and in the cloud. Experience communication as it should be: fluid, instinctive and profoundly empowering. Go to www.genesys.com for more information.

Each product has its own documentation for online viewing at the Genesys Documentation website or on the Documentation Library DVD, which is available from Genesys upon request. For more information, contact your sales representative.

Notice

Although reasonable effort is made to ensure that the information in this document is complete and accurate at the time of release, Genesys Telecommunications Laboratories, Inc. cannot assume responsibility for any existing errors. Changes and/or corrections to the information contained in this document may be incorporated in future versions.

Your Responsibility for Your System's Security

You are responsible for the security of your system. Product administration to prevent unauthorized use is your responsibility. Your system administrator should read all documents provided with this product to fully understand the features available that reduce your risk of incurring charges for unlicensed use of Genesys products.

Trademarks

Genesys and the Genesys logo are registered trademarks of Genesys Telecommunications Laboratories, Inc. All other company names and logos may be trademarks or registered trademarks of their respective holders. © 2018 Genesys Telecommunications Laboratories, Inc. All rights reserved.

Technical Support from VARs

If you have purchased support from a value-added reseller (VAR), please contact the VAR for technical support.

Ordering and Licensing Information

Complete information on ordering and licensing PureConnect products can be found in the [PureConnect Licensing Technical Reference](#).

Released by: Genesys Telecommunications Laboratories, Inc. <http://www.genesys.com/>

Table of Contents

1	Introducing the 420HD IP Phone	10
1.1	About Genesys' 420HD High Definition IP Phones	10
1.2	Cutting Edge Voice Quality & HD VoIP	10
2	Setting up the Phone	12
2.1	Unpacking	12
2.2	Device Description	12
2.2.1	Front View	12
2.2.2	Rear View	14
2.3	Cabling	15
2.4	Mounting the Phone	16
2.4.1	Mounting the Phone on a Desk	16
2.4.1.1	Routing the Handset Cable	17
2.4.2	Mounting the Phone on a Wall	18
3	Getting Started	19
3.1	LCD in Idle State	19
3.1	LCD in Ongoing Call State	19
3.2	Default Softkeys	20
3.3	Accessing Menus	22
3.4	Entering Numbers, Alphabetical Letters and Symbols	23
3.5	Displayed Messages	25
4	Customizing Your Phone	27
4.1	Selecting Language	27
4.2	Selecting Ring Tone	27
4.3	Enabling Call Waiting	28
4.4	Setting Date and Time	29
4.5	Changing LCD Contrast Level	30
4.6	Setting the LCD Backlight Timeout	31
4.7	Changing the Default Answer Device	32
4.8	Restarting the Phone	32
4.9	Adjusting Volume	33
4.9.1	Adjusting Ring Volume	33
4.9.2	Adjusting Tones Volume	33
4.9.3	Adjusting Handset Volume	34
4.9.4	Adjusting Speaker Volume	34
4.9.5	Adjusting Headset Volume	34
4.10	Defining Call Forwarding	35
4.11	Managing Your Personal Directory	36
4.11.1	Accessing the Directory	36
4.11.2	Adding Contacts to the Personal Directory	36
4.11.3	Editing a Contact	37
4.11.4	Deleting a Contact	38
4.11.5	Searching for a Contact	38
4.12	Configuring Keys	39
4.12.1	Configuring Function Keys [as Speed Dials]	39

4.12.1.1	Editing a Function Key Configured as a Speed Dial	40
4.12.1.2	Deleting a Function Key Configured for Speed Dialing	40
4.12.2	Configuring a Function Key for Paging	40
4.12.3	Configuring a Softkey	41
4.12.3.1	Programmable Softkeys (PSKs).....	43
4.12.3.2	Configuring Softkeys	43
4.12.4	Deleting a Configured Softkey	45
4.12.4.1	Configuring a Softkey for Speed Dialing	45
4.12.4.2	Configuring a Softkey as a Speed Dial + BLF	45
4.12.5	Configuring a Navigation Key Position Function	46
4.12.5.1	Removing a Configured Function.....	47
5	Performing Basic Operations	49
5.1	Using Audio Devices	49
5.2	Making Calls	49
5.2.1	Dialing	50
5.2.2	Redialing	50
5.2.3	Dialing a Missed Call	51
5.3	Answering Calls	51
5.4	Rejecting Incoming Calls	52
5.5	Silencing Incoming Calls.....	52
5.6	Ending an Established Call.....	52
5.7	Viewing Missed, Received and Dialed Calls.....	52
6	Performing Advanced Operations	55
6.1	Answering Waiting Calls	55
6.2	Placing Calls On Hold.....	55
6.3	Calling a Contact Listed in the Directory.....	55
6.4	Enabling Auto Redial	56
6.5	Pressing a Speed Dial Key to Make a Call	57
6.6	Transferring Calls	57
6.6.1	Performing an Attended Transfer	58
6.6.2	Performing a Semi-Attended Transfer	60
6.6.3	Performing a Blind Transfer.....	61
6.7	Hosting 3-Way Conference Calls.....	62
6.7.1	Leaving a 3-Way Conference You Set up without Disconnecting the Others	62
6.8	Muting Calls	62
6.9	Activating Do Not Disturb.....	63
6.10	Retrieving Voice Mail Messages.....	63
6.11	Using Two Lines	64
6.11.1	Choosing an Extension Line	64
6.11.2	Making a Call on an Extension Line	64
6.11.3	Making Two Calls on a Line.....	65
6.11.4	Making Multiple Line Calls	65
6.11.5	Toggling Between Multiple-Line Calls.....	65
6.11.6	Toggling Between Calls on the Same Line.....	66
6.11.7	Answering Calls	66
6.11.8	Ending Calls.....	66
6.12	Logging into a Remote HTTP/S Server	67
7	Troubleshooting	68

List of Figures

Figure 2-1: Front View	13
Figure 2-2: Rear View	14
Figure 2-3: Cabling	15
Figure 3-1: LCD in Idle State	19
Figure 3-2: LCD in Ongoing Call State	19
Figure 3-3: Menus	22
Figure 3-4: Alphanumerical Selection	23
Figure 3-5: Selected Alphanumerical Mode (Abc)	23
Figure 3-6: Entering a Symbol such as a Full Stop	24

List of Tables

Table 2-1: Front View Description	13
Table 2-2: Rear View Description	14
Table 3-1: LCD in Idle State	19
Table 3-2: LCD in Ongoing Call State	19
Table 3-3: Default Softkeys for all Menus.....	20
Table 3-4: Messages Displayed on LCD Indicating Processes In Progress.....	25
Table 4-1: Configurable Softkeys	41
Table 7-1: Troubleshooting.....	68

This page is intentionally left blank.



Preface

Welcome to the *420HD IP Phone User's Guide*. This guide shows users how to use the many features and functions of the Genesys 420 HD IP Phone.

Pursuant to the WEEE EU Directive, electronic and electrical waste must not be disposed of with unsorted waste. Please contact your local recycling authority for disposal of this product.

About the 420HD IP Phone

Genesys IP phones are based on proprietary High Definition (HD) voice technology, providing clarity and a rich audio experience in Voice-over-IP (VoIP) calls. The phones are fully-featured telephones that provide voice communication over an IP network, allowing you to place and receive phone calls, put calls on hold, transfer calls, make conference calls, and so on.

The phone offers a wide variety of management and configuration tools:

1. **Phone's LCD display user interface** - easy-to-use, menu-driven display screen, providing basic phone configuration and status capabilities
2. **Web interface** - provides a user-friendly Web interface that runs on a Web browser (Microsoft® Internet Explorer is the recommended browser).
3. **Configuration file** - text-based file (created using any plain text editor such as Microsoft's Notepad) containing configuration parameters and which is loaded to the phone using the Web interface or a TFTP, FTP, HTTP or HTTPS server.
4. **TR-069** for remote configuration and management
5. **CLI over Telnet**

Contacting Genesys Customer Care

If you have purchased support directly from Genesys, please read the [Genesys Care Support Guide for On-Premises](#) for complete information on how and when to contact Customer Care.

1 Introducing the 420HD IP Phone

Genesys' 420HD IP Phone is based on Genesys' High Definition voice technology, providing clarity and a rich audio experience in Voice-over-IP (VoIP) calls. The 420HD is a two-line, two concurrent calls per line premium model which includes a large monochrome multi-language graphic LCD display.

The 420HD IP Phone is a fully-featured telephone that provides voice communication over an IP network, allowing you to place and receive phone calls, put calls on hold, transfer calls, make conference calls, etc.

Read this User's Manual to learn how to operate this product and take advantage of its multiple features.

1.1 About Genesys' 420HD High Definition IP Phones

Genesys 420HD High Definition IP Phones offer a new dimension of voice call quality and clarity for the IP Telephony market. This new IP Phones further expands Genesys' product offering for the service providers' hosted services, Enterprise IP telephony and Enterprise contact centers markets. As a natural addition to the Genesys' Soft Phone, and Genesys' offers of AudioCodes Media Gateway, Session Border Controller, and Session Experience Manager, the Genesys' High Definition IP Phones enable Systems Integrators and end-customers to build end-to-end customer service & enterprise communication solutions. The Genesys' High Definition IP Phones meet a growing demand for High Definition VoIP solutions in end-user phones and terminals, improving the productivity and efficiency of business communications with new quality standards set by the High Definition voice technology.

1.2 Cutting Edge Voice Quality & HD VoIP

Based on the advanced, robust and field-proven VoIPerfectHD™ software, Genesys' IP Phones are designed to utilize the most popular wideband coders. Each of these phones features enhanced proprietary capabilities, such as packet loss concealment, high quality wideband acoustic echo canceler, and low-delay adaptive jitter buffers to enrich the HDVoIP experience.

This page is intentionally left blank.

2 Setting up the Phone

2.1 Unpacking

When unpacking, ensure that the following items are present and undamaged:

420HD IP Phone / Stand

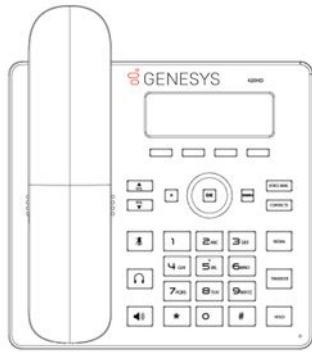

Handset / Cord

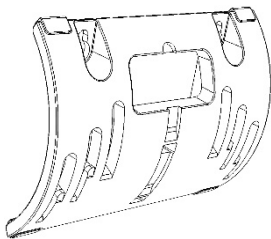

Cat 5e Ethernet Cable

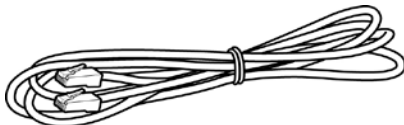

AC Power Adapter (Optional)



If anything appears to be missing or broken, contact the distributor from whom you purchased the phone for assistance.

2.2 Device Description

Use the graphics below to identify and familiarize yourself with the device's hardware functions.

2.2.1 Front View

The front view of the phone is shown in [Figure 2-1](#) and described in [Table 2-1](#).

Figure 2-1: Front View

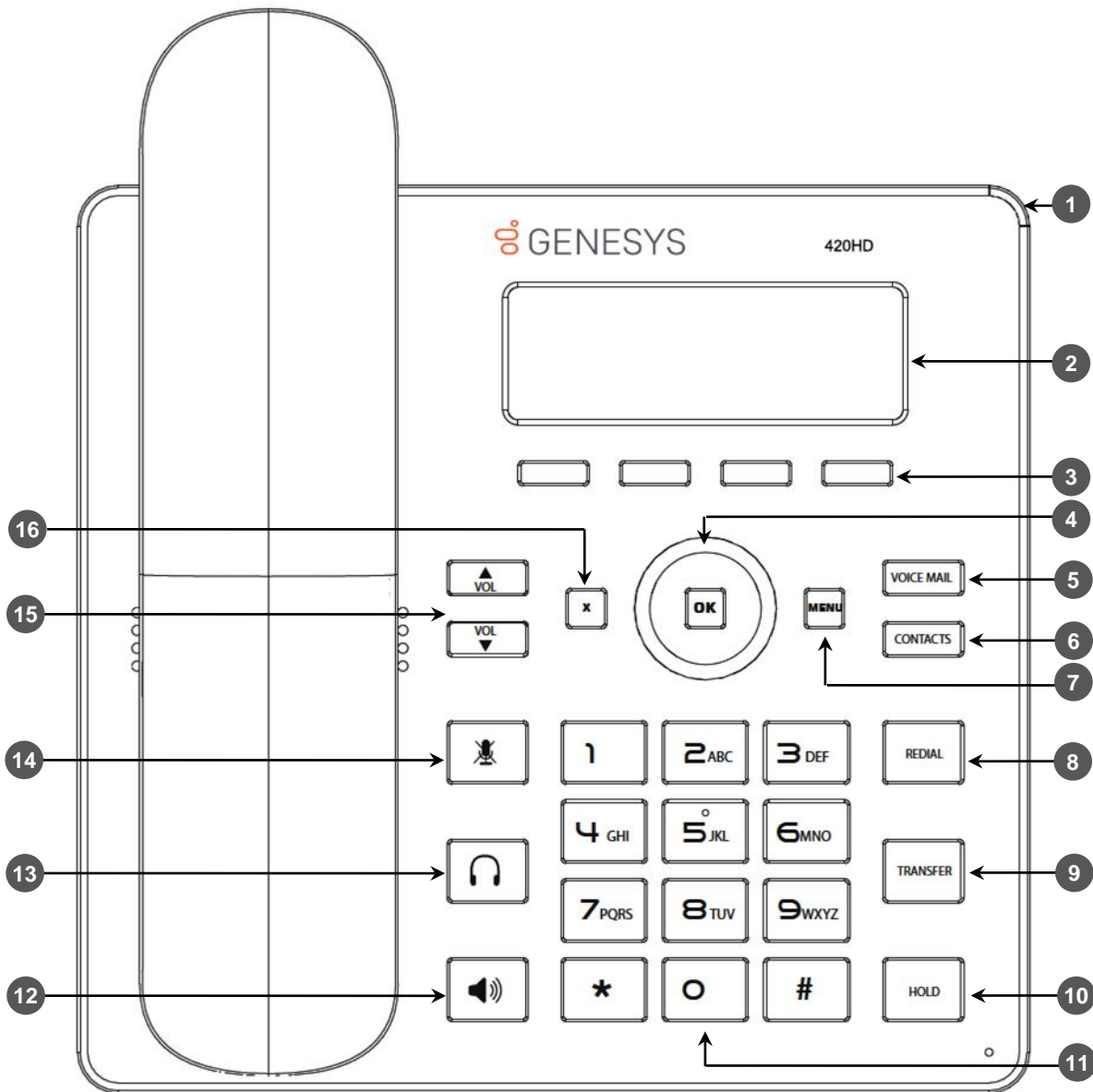

Table 2-1: Front View Description

Item #	Label/Name	Description
1	Ring LED	Flashing blue light visually indicates an incoming call.
2	LCD	Liquid Crystal Display - interactive screen displaying calling information, enabling you to set up phone features.
3	Softkeys	See Section 3.2.
4	Navigation Control / OK	Press the upper rim to scroll up menus/items in the LCD display screen. Press its lower rim to scroll down. Press its left or right rim to move the cursor left or right (when editing a contact number for example). Press the OK button to select a menu/item/option.
5	VOICE MAIL	Retrieves voice mail messages.
6	CONTACTS	Press to directly access the Personal directory.

Item #	Label/Name	Description
7	MENU	Accesses menus (1) Call Log (2) Directory (3) Speed Dial (4) Settings (5) Status (6) Administration.
8	REDIAL	Accesses recently dialed numbers; one can be selected to redial.
9	TRANSFER	Transfers a call.
10	HOLD	Places an active call on hold.
11	Alphanumerical Keypad	Keys for entering numbers, letters and symbols (e.g., colons).
12	SPEAKER	Activates the speaker, allowing a hands-free conversation.
13	HEADSET	Activates a call using an external headset.
14	MUTE	Mutes a call.
15	▲ VOL	Increases or decreases the volume of the handset, headset, speaker, ring tone and call progress tones.
	VOL ▼	
16	x	Cancel an action, such as dialing a number, after beginning it.

2.2.2 Rear View

The rear view of the phone is shown in the figure below and described in the table below.

Figure 2-2: Rear View

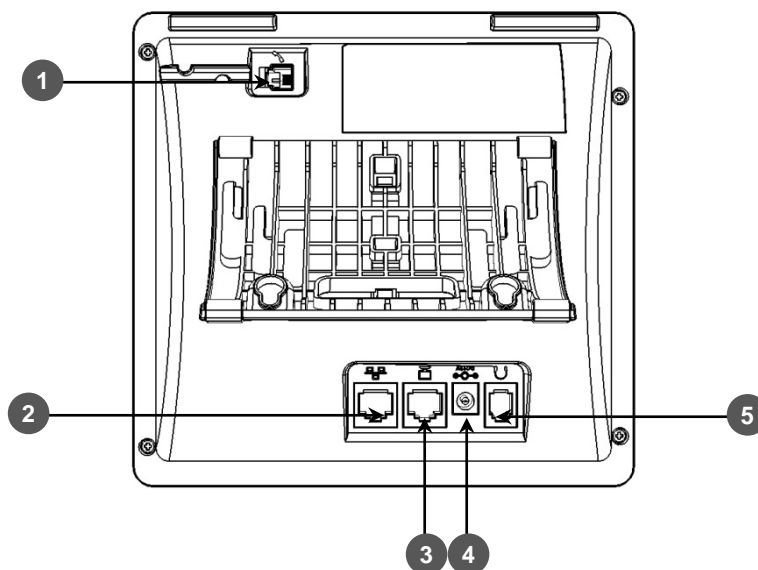







Table 2-2: Rear View Description

#	Label	Description
1		Handset jack, i.e., RJ-9 port, to connect the handset.
2		RJ-45 port to connect to the Ethernet LAN cable for the LAN connection (uplink - 10/100 Mbps). If you're using Power over Ethernet (PoE), power to the phone is supplied from the Ethernet cable (draws power from either a spare line or signal line).
3		RJ-45 port for connecting the phone to a PC (10/100 Mbps downlink).

#	Label	Description
4	 DC12V	12V DC power jack that connects to the AC power adapter.
5		Headset jack, i.e., RJ-9 port that connects to an external headset.

2.3 Cabling

This section shows how to cable your phone.

Figure 2-2 Cabling

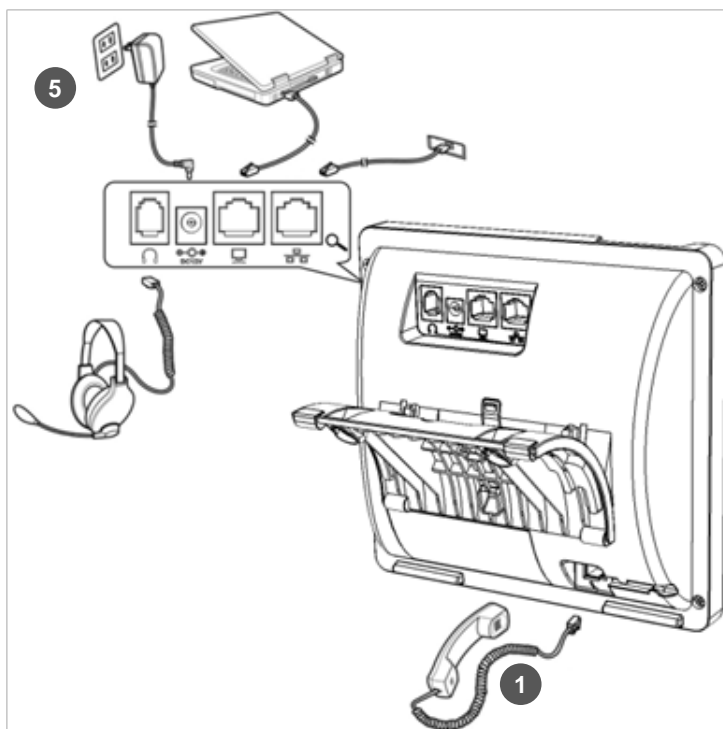

Action	Description
1	Connect the <i>short, straight end of the cord</i> to the handset. Connect the <i>longer, straight end</i> to the jack (RJ-9 port, for the handset) on the phone.
2	Connect the RJ-45 LAN port to your LAN network (LAN port or LAN switch/router), using a CAT 5 / 5e Ethernet cable
3	Connect the RJ-45 PC port to a computer, using a CAT 5 / 5e straight-through Ethernet cable
4	Connect the connector tip of the AC power adapter to the phone's power socket (labelled DC 12V). Connect the two-prong AC adapter directly to the electrical wall outlet. When the phone powers up, all the LEDs momentarily light up
5	Connect the RJ-9 headset jack to a headset (optional)



Note: If the LAN to which the phone is connected supports Power over Ethernet (PoE), no AC adapter is required; the phone receives power from the Ethernet network.



Prior to connecting power, see the *Compliance and Regulatory Information* at www.audiocodes.com/library.

2.4 Mounting the Phone

The phone can be mounted on a:

- Desk (see Section 2.4.1 below)
- Wall (see Section 2.4.2 on page 18)

2.4.1 Mounting the Phone on a Desk

You can mount the phone on a desk or flat surface.

➤ **To mount the phone on a desk or flat surface:**

1. Off-hook the handset (if on-hook) and place the phone upside down, i.e., base-up, on your desktop.
2. On the phone's base, identify outer rails.
3. On the phone's stand, identify outer notches.
4. Invert the stand and align its outer notches with the base's outer rails.
5. Insert the stand's outer notches into the base's outer rails and slide the notches along the rails until the stand click-locks into the base.
6. Revert the phone and stand it on the desktop.

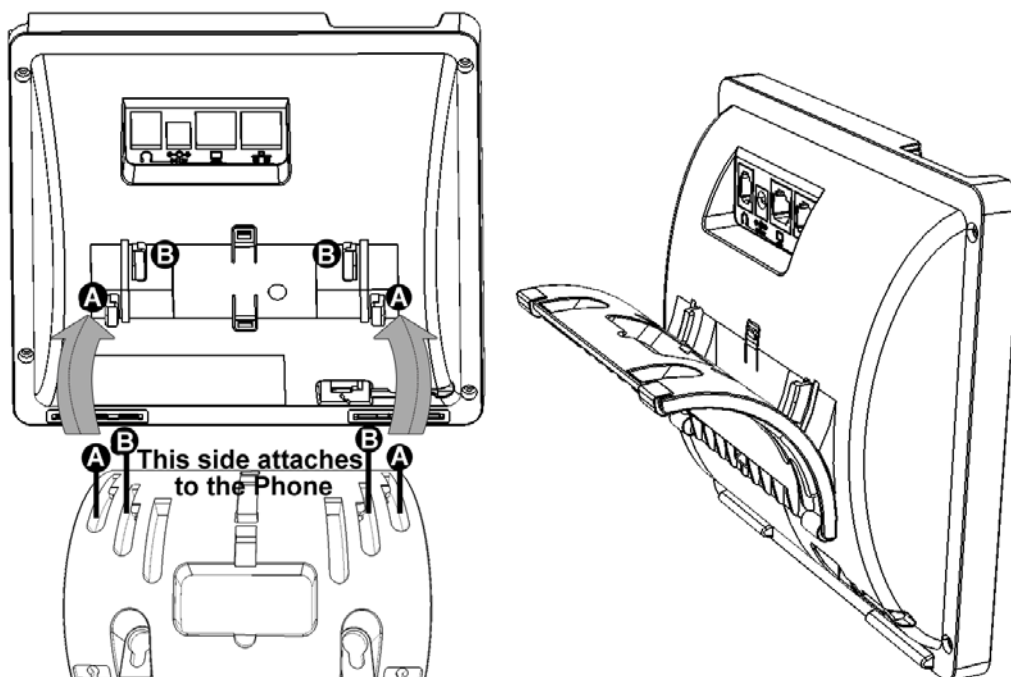

2.4.1.1 Routing the Handset Cable

The phone features a groove for routing the handset cable.

2.4.2 Mounting the Phone on a Wall

This section shows you how to mount the phone on a wall or wall plate.

➤ **To mount the phone on a wall:**

1. Attach the stand of the phone for the purpose of a wall mounting:
 - a. Detach the base.

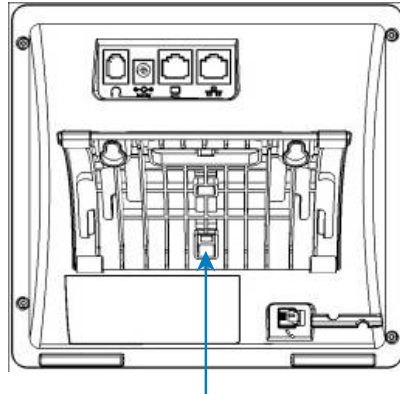

To detach the phone's stand, push this button

- b. Attach it again as you did for a desktop mounting (see Section 2.4.1 on page 16) only now make sure that it's flatly aligned to lie flush against the wall, i.e., slide the *middle rails* of the phone stand onto the phone base's inner notches.

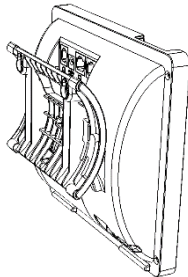

2. Connect the AC power adapter, LAN and PC cords.
3. In the wall, drill two horizontal holes at a distance of $3 \frac{15}{16}$ inches (100 mm) from one another, in line with the template.
4. Insert two masonry anchors into the holes if necessary.
5. Thread two screws (not supplied) into the two masonry anchors; ensure that the heads extend sufficiently (about $\frac{3}{16}$ inch or 5 mm from the wall) for the phone stand's keyhole slots to hang on.
6. Hang the phone stand's keyhole slots on these screws.

3 Getting Started

The phone features an LCD, providing an intuitive, menu-driven user interface for configuring the phone and viewing call information.

This section shows how to use the phone's LCD.

3.1 LCD in Idle State

The figure below shows the phone's LCD in idle state. See the table below for reference.

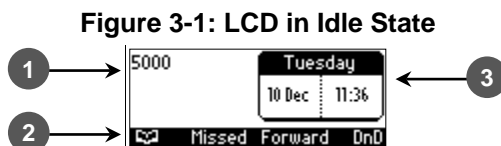

Table 3-1: LCD in Idle State

Reference	Description
1	Extension lines. An extension line will only be displayed after your system administrator configures it using the Web interface. See the <i>Administrator's Manual</i> for details on how to configure a line.
2	Softkeys (Directory, Missed, Forward and DnD ¹). To activate a softkey, press the key below it on the device.
3	Day, Date and Time.

3.1 LCD in Ongoing Call State

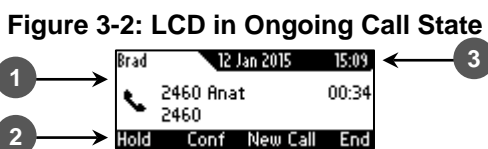

Table 3-2: LCD in Ongoing Call State

Reference	Description
1	Extension lines. An extension line will only be displayed after your system administrator configures it using the Web interface. See the <i>Administrator's Manual</i> for details on how to configure a line.
2	Softkeys (Hold, Conf, New Call and End ²). To activate a softkey, press the key below it on the device.
3	Day, Date and Tim

¹ The default softkeys in the idle screen (for more information, see Section 3.23.2).

² The default softkeys in the ongoing call state screen (for more information, see Section 3.23.2).



3.2 Default Softkeys

The table below describes softkeys displayed in the LCD according to *menu level* currently accessed. To activate a softkey, press the key on the phone keypad, located below the screen, corresponding to the softkey.



Note: Softkeys can also be customized. For more information, see Section 4.12.3.

Table 3-3: Default Softkeys for all Menus

Softkey	Description
	Opens the phone's directory. Lets you select a contact in the Personal directory . Displayed in idle state as well as (for example) after lifting the handset.
Missed	Displays missed calls.
Forward	Defines and activates call forwarding.
DnD	Displayed in idle state. Activates the Do not Disturb feature.
Select	Selects a menu or menu option. Identical to the OK key. Either can be used.
Back	Displayed for example after pressing the MENU key as well as after selecting any of the submenu's under it. Returns you to the previous screen state or menu level.
Dial	Displayed after a number is keyed, a directory contact is selected, or a logged call is selected. Dials the phone number / directory contact / logged call.
Save	Saves settings.
Detail	Displayed after a number is keyed, a directory contact is selected, or a logged call is selected. Dials the phone number / directory contact / logged call.
Clear	Displayed for example after pressing the first digit key of a phone number. Deletes from right to left each time the digit or character is pressed. To delete all digits/characters, keep pressed until all are deleted.
New Call	Displayed after you dial a number and the call is answered. Also shown after <i>you</i> answer a call. Opens the NEW CALL screen in which you can key a number or URL to include in the current call.
Conf	Displayed after you dial a number and the call is answered. Also shown after <i>you</i> answer a call. Opens the CONFERENCE WITH screen in which you can key a number or URL to include in the current call.
Hold	Lets you place the call on hold. Displayed when you are in an active call.
URL	Displayed after lifting the handset, after selecting New Call , Conf or Trans , and after keying the  key. Lets you call a URL.
	Opens the Call Log submenus. Lets you select All Calls , Missed Calls , Received Calls or Dialed Calls . Displayed after lifting the handset. Also displayed after New Call or Conf is selected.
A/a/l	Enables choosing letters or digits (123). The letters option can be all caps (ABC), all small letters (abc) or first letter capitalized (Abc).
Start	Displayed after pressing Forward > selecting an extension line > selecting when to forward. Activates call forwarding.
Cancel	Cancels the currently initiated call or configuration.

Softkey	Description
End	Displayed for example after pressing the Dial softkey and when the called party lifts the handset/accepts the call. Also displayed after accepting an incoming call or lifting the handset to answer. Ends the call.
Edit	Displayed after a menu/submenu item to be edited is selected. Enables editing the selected item.
Delete	Displayed you select the Detail softkey after selecting a call under a Call Log submenu (e.g., under Missed Calls). Before deleting the call, a warning prompt is displayed.

3.3 Accessing Menus

Menus are used to access information and to configure the phone. Example: Use **Personal directory** under **Directory** to add contacts; use **Missed Calls** under **Call Log** to view missed calls and reply to them; use **Network Status** under **Status** to view the phone's dynamic IP address.

The figure below shows the phone's menus and submenus.

Figure 3-3: Menus

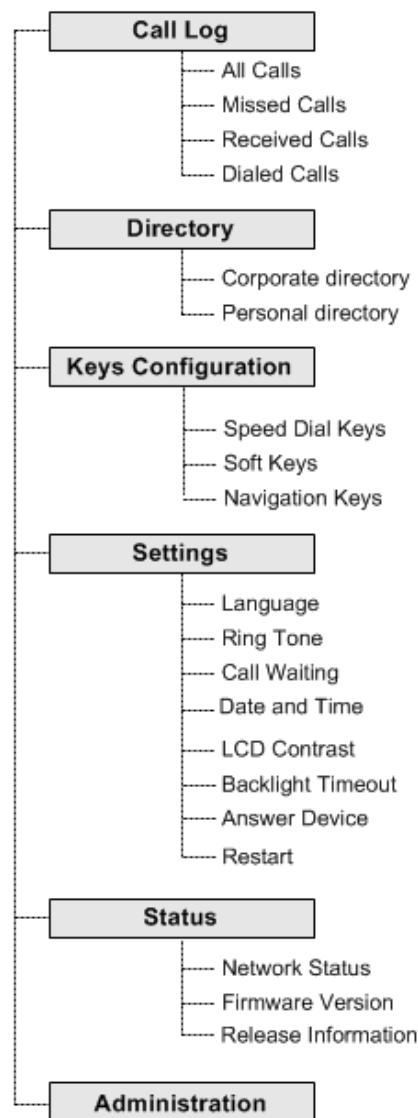

Note:

- The Administration menu is intended for system administrators only. It is password protected. See the *Administrator's Manual* for details.
- If you define a second extension line, the Call Log menu displays menu items per extension.
- The **Soft Keys** item under the Keys Configuration menu is not displayed on IP phones in a Genesys or BroadSoft environment when the Automatic Call Distribution (ACD) feature is enabled.



- **To access the menus:**
 - Press the **MENU** key located on the device.
- **To navigate to menus and items:**
 - Press the navigating control's upper and lower rim -OR- press the listed item's number on the keypad, e.g., press **3** to navigate to Speed Dial.
- **To select a menu or menu item:**
 - Press the **Select** softkey or press the navigation control's **OK** button.
- **To cancel and move to a previous menu level:**
 - Press the **Back** softkey.

3.4 Entering Numbers, Alphabetical Letters and Symbols

The phone's alphanumerical keypad lets you to enter alphabetical letters, numbers and symbols. To select either alphabet mode, number mode or symbol mode, press the **A/a/1** softkey successively or press the **#** pound key successively.

To define a contact name, you need alphabet mode. To define an IP address, you need to revert from number mode to symbol mode: and back to number, etc. To dial a number to make a new call, press its key on the keypad when the LCD is in idle state.

- **To select a mode:**
 1. Successively press the **A/a/1** softkey or **#** key to select the mode required:

Figure 3-4: Alphanumerical Selection



2. Choose either:
 - **abc** = lower case letters
 - **ABC** = upper-case letters
 - **Abc** = first-letter upper case, the rest lower case
 - **123** = numerical mode (i.e., numbers)

After selecting, the LCD displays your selection.

Figure 3-5: Selected Alphanumerical Mode (Abc)



3. To enter a letter, press the required alphanumerical key on the keypad. Successive presses on the same key moves you to that key's next letter. Pressing another key enters the first letter indicated on it. Long-pressing a key when in alphabet mode enters the numerical digit corresponding to the pressed key.

- **To enter a symbol such as a period (full stop):**
 1. (Mandatory) Press the **A/a/1** softkey successively to select alphabet mode lower case letters (**abc**) (see 1 below).
 2. Press the **1** key on the keypad; a semi-colon is entered. Immediately press **1** again; a colon is

entered. Immediately press **1** again; a period is entered.

- To revert to numbers, for example, press the pound **#** key successively to choose **123** mode (see [2](#) below).

Figure 3-6: Entering a Symbol such as a Full Stop



Successively pressing the **1** key produces:

- ; (semi-colon)
- : (colon)
- . (period)
- @ (at)
- # (pound)
- \$ (dollar)
- % (percentage)
- ^ (caret)
- & (ampersand)
- + (plus)
- - (minus)
- _ (underscore)

Note that you can also use the star key to enter a full stop, asterisk (*) symbol, and @ symbol.

3.5 Displayed Messages

Messages indicating processes in progress, displayed in the LCD, include:

Table 3-4: Messages Displayed on LCD Indicating Processes In Progress

Message	Description
Initializing	Initializing
Discovering LLDP	Discovering Link Layer Discovery Protocol (LLDP) for initialization
Discovering CDP	Discovering Cisco Discovery Protocol (CDP) for initialization
Acquiring IP	Acquiring an IP address from a DHCP server
Initializing Network	Initializing the network
Registering	Registering to a SIP proxy server (at phone bootup)
Registration in Progress	SIP Registration in Progress
Registration Failure	SIP Registration failure
Downloading Firmware File	Downloading a firmware file
Upgrading Firmware	Upgrading the phone's firmware
Updating Configuration	Loading a configuration file
Generate Certificate	Generates the phone's security certificate
LAN link failure	The phone is not physically connected to a network device because <ul style="list-style-type: none"> ▪ the network cable is not plugged into the phone ▪ the network device / network cable is damaged and/or ▪ the network device is shut down
IP Duplication and Reboot	The phone received an IP address already taken by another device. This may have been due to <ul style="list-style-type: none"> ▪ a problem with the DHCP server -or- ▪ another device was given a static IP address within the range of the DHCP server



Note: The status of factory installed certificates is also displayed. The phone start up (boot) process now visually displays the following certificate status indications:

- Installed
- Self-Signed
- Not-Installed

This page is intentionally left blank.

4 Customizing Your Phone

You can customize your phone for enhanced usability.

4.1 Selecting Language

The LCD supports multiple languages. English is the default but you can change it to another.

➤ **To change the default language:**

1. Access the **Languages** screen (**MENU** key > **Settings** > **Language**).



2. Navigate to the language you require.
3. Press the **Select** softkey.
4. Press the **Save** softkey to apply your setting.



4.2 Selecting Ring Tone

The phone provides a selection of ring tones that you can choose from to indicate incoming calls. If line extensions are defined on your phone, you can assign a ring tone per line extension.

➤ **To select a ring tone:**

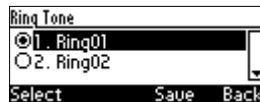
1. Access the **Ring Tone** screen (**MENU** key > **Settings** > **Ring Tone**).
2. In the **Ring Tone** screen, select **All Extensions**, or select **Extension 1** or **Extension 2** (if extensions are configured).
3. Navigate to a ring tone of your choice. A sample of each ring tone is played as you navigate through the list.



4. Press the VOL  or VOL  key on the keypad to set ring tone volume. You can also increase or decrease ring tone volume when the phone is in idle state or when a call is incoming (see Section 4.9.1).



A few seconds after adjusting the volume level, the Ringer Volume indication is hidden.

5. Press the **Select** softkey.
6. Press the **Save** softkey to apply your setting.

4.3 Enabling Call Waiting

You can enable or disable the call waiting feature.

➤ **To enable or disable call waiting:**

1. Access the **Call Waiting** screen (**MENU** key > **Settings** > **Call Waiting**).

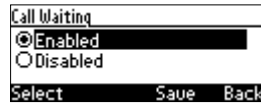

2. Navigate to one of the following:
 - **Disabled** (disables call waiting)
 - **Enabled** (enables call waiting)
3. Press the **Select** softkey.
4. Press the **Save** softkey to apply your setting.

4.4 Setting Date and Time

You can manually set date and time displayed on the phone. If a Network Time Protocol (NTP) server is deployed and enabled by your administrator, however, then date and time are automatically retrieved over the Internet from the server and manually setting them will not be possible. You'll receive this message:



Notes:



- It's recommended to implement an NTP server (system administrators can see the *Administrator's Manual* for detailed information).
- If date and time are manually set, the settings are not retained after rebooting the phone or powering off. You will need to manually reset date and time if you reboot or power off.

➤ To set date and time:

1. Access the **Date and Time** screen (**MENU** key > **Settings** > **Date and Time**).



2. Navigate down to the **Date format** option and set **European** or **American**.
3. Navigate to the **Date** option and modify using the **Clear** softkey.
4. Navigate to the **Time** option. The time is in the format hhmmss. Modify using the **Clear** softkey.



5. Navigate to the **Time format** option.



6. Press the navigation control's left rim to change the format from **24h** to **12h** if required, or press the **Select** soft key.
7. Press the **Save** softkey to apply your setting.

4.5 Changing LCD Contrast Level

The phone's LCD supports 0-30 contrast levels. You can select the level that suits you best.

➤ **To change the LCD's contrast level:**

1. Access the **LCD Contrast** submenu (**MENU** key > **Settings** > **LCD Contrast**).

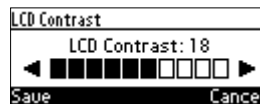

2. Press the navigation control's left or right rim to navigate to the contrast level that suits you best.
3. Press the **Save** softkey to apply your setting.

4.6 Setting the LCD Backlight Timeout

You can set the duration, in seconds, for which the phone's backlight is lit when the phone is not being used (idle). After the duration expires, the backlight turns off. You can opt to have the backlight on all the time by selecting the **Always on** option.

➤ **To set the LCD's backlight timeout:**

1. Access the **Backlight Timeout** screen (**MENU** key > **Settings** > **Backlight Timeout**).

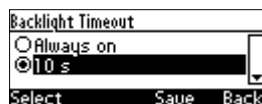

2. Navigate to **Always on** or **10 seconds** (default) **20 seconds**, **30 seconds**, **40 seconds**, **50 seconds** or **60 seconds**).
3. Press the **Select** softkey.
4. Press the **Save** softkey to apply your setting.

4.7 Changing the Default Answer Device

You can change the default answer device. The default answer device is the speaker.

➤ **To change the default to handset or headset:**

1. Access the **Answer Device** screen (**MENU** key > **Settings** > **Answer Device**).



2. Navigate to **Speaker** or **Headset**, and then press the **Select** softkey.
3. Press the **Save** softkey to apply the setting.

4.8 Restarting the Phone

You can restart the phone. You can use this feature to initially troubleshoot a phone issue (for example), as you do with a pc issue.

➤ **To restart the phone:**

1. Access the **Restart** screen (**MENU** key > **Settings** > **Restart**).

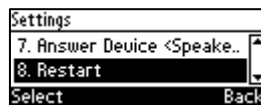

2. Select **Restart** and then in the warning prompt that is displayed, press the **Yes** softkey.

4.9 Adjusting Volume

You can adjust the volume of the phone's:

- Ring
- Tones (e.g., dial tone)
- Handset
- Speakerphone
- Headset



4.9.1 Adjusting Ring Volume

You can adjust the volume of the ring indicating an incoming call.





Note: By default, you can adjust ringing volume in the phone's LCD. Your network administrator, however, can block this capability and provision ringing volume remotely. If this was done and you need to adjust the ringing volume, consult your network administrator.

➤ To adjust ring volume:

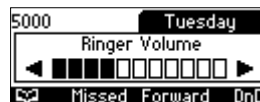
1. When the phone is in idle state (i.e., not in use), press the VOL  or VOL  key; the Ringer Volume bar is displayed on the screen:





2. Press the VOL  and/or VOL  key on the phone to adjust the volume. After adjusting, the Ringer Volume level disappears from the screen.



4.9.2 Adjusting Tones Volume

You can adjust the volume of the phone's tones, including dial tone, ring-back tone and all other call progress tones.

➤ To adjust tones volume:

1. Off-hook the phone (using handset, speaker or headset).
2. Press the VOL  or VOL  keyboard key; the Tones Volume bar displays on the screen:



3. Press the VOL  or VOL  key to adjust the volume. After adjusting, the Tones Volume bar disappears from the screen.

4.9.3 Adjusting Handset Volume

You can adjust the volume of the handset during a call or when making a call. After changing the volume, the newly adjusted level applies to all subsequent handset use.

➤ **To adjust handset volume:**

1. Off-hook the handset and make a call. During the call, press the VOL  or VOL  key:



2. After adjusting the volume, the Handset Volume bar disappears from the screen.

4.9.4 Adjusting Speaker Volume

You can adjust the volume of the speaker during a call. After changing the volume, it applies to all subsequent speaker use.

➤ **To adjust the speaker volume:**

1. Press the **SPEAKER** key and make a call. During the call, press the VOL  or VOL  key:





2. After adjusting the volume, the Speaker Volume bar disappears from the screen.

4.9.5 Adjusting Headset Volume

You can adjust the volume of the headset during a call. After changing the volume, it applies to all subsequent headset use.

➤ **To adjust the headset volume:**

1. During a call, press the **HEADSET** key.
2. Press the VOL  or VOL  key:



After adjusting the volume, the Headset Volume bar disappears from the screen.

4.10 Defining Call Forwarding

This feature allows an incoming call to be automatically redirected to another phone number if a user-defined condition is met, e.g., if the line is busy. You can also define call forwarding per extension or for all extensions - if you've defined extensions.

➤ To define call forwarding:

1. Press the **Forward** softkey when the LCD is in idle state:

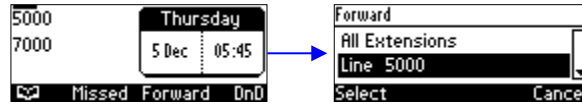

2. In the Forward screen, navigate to a line or to **All Extensions** and press the **Select** softkey:

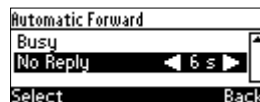

3. In the Automatic Forward screen, navigate to a forwarding condition:

- **Always:** The call is always forwarded.
- **Busy:** The call is forwarded when the line is busy.
- **No Reply:** The call is forwarded if the incoming call is not answered after a user-defined time in seconds. To select the time (1-99 seconds), press the navigation control's left or right rim.

4. Press the **Select** softkey and define the destination to where you want the call forwarded:

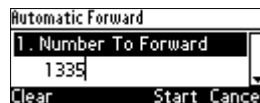

- **Number To Forward:** enter the number to which to forward the call.
 - **Select from Directory:** navigate to this option and then select an existing contact to whom to forward the call.
 - Scroll down to select a destination from the history of numbers previously forwarded to.
5. Press the **Start** softkey to activate call forwarding; an → icon appears adjacent to the extension/s on the idle screen indicating that call forwarding is active:



➤ To deactivate call forwarding:

- When the phone is on-hook, press the **Forward** softkey; the → icon disappears from the extension/s on the screen.

4.11 Managing Your Personal Directory

You can add contacts to the Personal Directory and edit and delete them if necessary. After adding a contact, you can call the contact directly from the directory (see Section 6.3 on page 55). If you receive an incoming call from a contact listed in the directory, the LCD displays the name listed. If you define a speed dial key to the contact, you can press it to call them.



Note: You can add a maximum of 700 contacts to your Personal Directory.

4.11.1 Accessing the Directory

It's necessary to access the Personal directory in order to perform the management operations subsequently described.

➤ **To access the Personal directory:**

1. Press the **CONTACTS** key on the phone -OR- when the LCD is in idle state, press the  softkey -OR- press the **MENU** key and navigate to **Directory > Personal directory**.

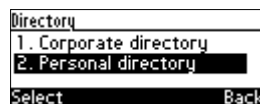

2. Press the **Select** softkey to add a contact to the directory, edit or modify contact information, delete a contact, or search for a contact:

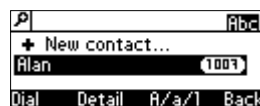

4.11.2 Adding Contacts to the Personal Directory

You can add a contact to the Personal Directory. You can enter the contact's:

- Name
- Office number
- Home number -and/or- mobile number

You can also define a Speed Dial key to quickly dial that contact.

➤ **To add a contact to the phone directory:**

1. Access the **Personal directory**.
2. Select **+ New contact**:



3. In the 'Modify contact' screen, key in the 'Name' of the new contact (see Section 3.4 on page 23 for information on alphanumeric modes).
4. Navigate down and key in the new contact's 'Office' number (see Section 3.4 on page 23 for details). Optionally, navigate down and key in the new contact's 'Home' and 'Mobile' numbers as well.
5. Press the **Sp. Dial** softkey to define a Speed Dial key to this contact (if required) and in the

Assign to Speed Dial screen that opens, navigate to an Empty:

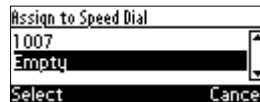

6. Press the **Select** softkey; a Speed Dial key to the contact is defined. For detailed information on defining a Speed Dial key, see Section 4.12 on page 39.
7. Press the **Save** softkey; 'Contact Saved' is displayed.
8. To view and edit a Speed Dial, in the 'Contact details' screen navigate down to the number to which the Speed Dial points and press the **Sp.Dial** softkey; navigate down to this screen:

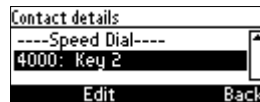

4.11.3 Editing a Contact

You can edit contact information.

➤ **To edit contact information:**

1. Access the **Personal directory** and navigate to the name of the contact to edit:

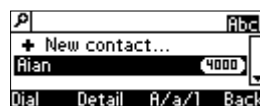

2. Press the **Detail** softkey:

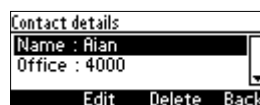

3. Press the **Edit** softkey:



4. Modify the contact's details (use the **Clear** softkey) and press the **Save** softkey.

4.11.4 Deleting a Contact

You can delete a contact from your personal directory.

➤ **To delete a contact:**

1. Access the **Personal directory** and navigate to the contact to delete:

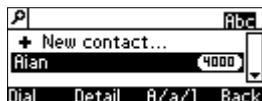

2. Press the **Detail** softkey; the contact details are shown.
3. Press the **Delete** softkey; a 'Delete current contact?' warning message appears:



4. Press the **Yes** softkey to remove the contact from the phone directory or **No** if you want to keep the contact in the directory; the contact is removed from the directory.

4.11.5 Searching for a Contact

You can quickly and easily locate a contact in the directory. This is especially useful if you have a long list of contacts.

➤ **To search for a contact:**

- Access the phone directory.
 - Navigate to the contact in the list
 - OR-
 - Key the first letter in the contact's name using the keypad. As you press the key, the directory locates contacts whose names begin with that letter. For example, to search for the contact John, as you press the 'j' key the directory locates contacts whose names begin with "j". As you key in the next letter, i.e., 'o', contacts whose names begin with 'jo' appear, etc.

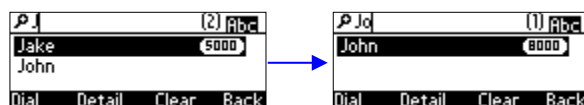

4.12 Configuring Keys

This section shows how to configure keys. You can configure Function Keys, Soft Keys, and Navigation Keys.

➤ **To perform keys configuration:**

1. Access the Keys Configuration screen (**MENU** key > **Keys Configuration** menu):

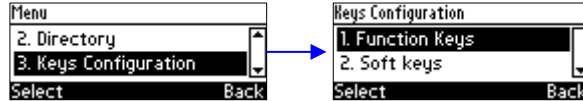

4.12.1 Configuring Function Keys [as Speed Dials]

You can configure up to nine Function Keys as Speed Dials key for the 1-9 keys on the keypad. When long-pressed, each key can dial a configured telephone number.

➤ **To configure a Function Key as a Speed Dial:**

1. Access the Function Keys screen (**MENU** key > **Keys Configuration** > **Function Keys**):

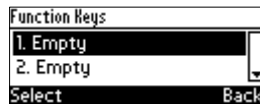

2. Navigate to an 'Empty' and then press the **Select** softkey:

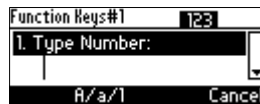

Note: You can alternatively long-press a key (1-9) until the above screen opens.

3. Configure a phone number to assign the speed dial to:
 - **User-defined number:** In the 'Type Number' field, enter the phone number to which the Speed Dial will dial and press the **Save** softkey; the new Speed Dial is created and shown in the Function Keys screen:

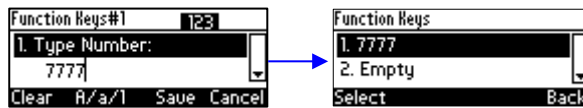

-OR-

- **Contact from phone directory:** Instead of entering the phone number in the 'Type Number' field, navigate to and select **Select from Directory** > **Personal/Corporate directory** and then navigate to the defined contact in the directory:

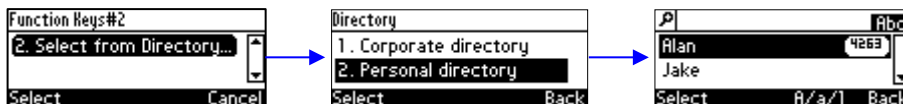

4. Select the contact and press the **Save** softkey; the new Speed Dial is created and shown in the Function Keys screen.



Note: You can also configure a Speed Dial when adding a contact to your phone directory or when editing a contact in the phone directory (see Section 4.11.2).

4.12.1.1 Editing a Function Key Configured as a Speed Dial

You can edit a Function Key configured as a Speed Dial.

➤ **To edit a Function Key configured as a Speed Dial:**

1. Access the Function Key screen (**MENU** key > **Keys Configuration** > **Function Keys**).
2. Navigate to the configured speed dial to edit, and then press the **Select** softkey.
3. Edit as required. Press the **Clear** softkey to delete digits from right to left.
4. Press the **Save** softkey to save your settings.

4.12.1.2 Deleting a Function Key Configured for Speed Dialing

You can delete a Function Key configured as a Speed Dial.

➤ **To delete a Function Key configured for speed dialing:**

1. Access the Function Key screen (**MENU** key > **Keys Configuration** > **Function Keys**).
2. Navigate to the configured speed dial to delete, and then press the **Select** softkey.
3. In the 'Type Number' field, delete the entire number by pressing the **Clear** softkey.
4. Press the **Save** softkey; 'Empty' is now displayed in the Function Keys screen.

4.12.2 Configuring a Function Key for Paging

Live announcements can be made (paged) from a phone to a group of phones, to notify a team (for example) that a meeting is about to commence. The paged announcement is multicast via a designated group IP address, in real time, on all idle phones in the group, without requiring listeners to pick up their receivers. The name of the group is displayed on phone screens when the paging call comes in.



Note: The feature must be enabled in the Web interface by the network administrator before a Functional Key can be configured for paging. See the *Administrator's Manual* for more information.

Up to nine Function Keys, the **1-9** keys on the keypad, can be configured for paging.

➤ **To configure a Function Key for paging:**

1. Open the Function Keys screen (**MENU** key > **Keys Configuration** > **Function Keys**):

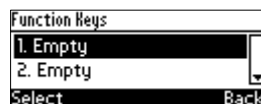

Note: You can alternatively long-press a key (1-9) until the Function Key Type screen opens.

2. Navigate to and select an 'Empty' and then navigate to and select **Paging**.

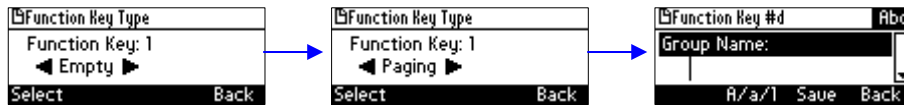

- In the 'Group Name' field, enter the name of the group. The name will be displayed in the phone's screen when there's an incoming / outgoing paging call. All phones must be configured with the same name for them to be in a group.



- Navigate down to the 'Multicast Address' field and enter the paging group's multicast IP address. Default = 224.0.1.0. All phones must be configured with the same multicast address for them to be in a group.
- Navigate down to the 'Multicast Port' field and enter the group's port. Default: 8888. All phones must be configured with the same port for them to be in a group.
- Press the **Save** softkey.

4.12.3 Configuring a Softkey

Located under your phone's LCD are four configurable softkeys. The idle screen by default displays (from left to right) (Directory), Missed, Forward, and DnD softkeys:

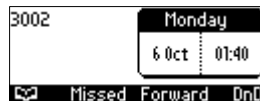

These four softkeys may be reconfigured with different key events or additional softkeys may be added. When additional softkeys (more than three) are added, then the right-most button softkey button is set as **More**. When you press this button, you are scrolled to the next page of the Softkey LED display.



Notes:

- You can scroll up to seven pages according to the supported number of configured softkeys (see the *Administrator's Manual*).
- Softkeys can only be configured on the phone for the Idle state. To configure softkeys for the Ongoing call state and to configure Programmable Softkeys (PSKs), see the *Administrator's Manual*.
- For other call states such as Hold and Conference, softkeys cannot be configured.
- When the Automatic Call Distribution (ACD) feature is enabled, you cannot configure softkeys (see the *Administrator's Manual*).

The table below describes the key events that can be assigned to softkeys.

Table 4-1: Configurable Softkeys

Softkey	Description
Received Calls	Displays a list of all received calls.
Dialed Calls	Displays a list of all dialed calls.
All Calls	Displays a list of all calls (dialed and received).
Speed Dial	Lets you configure a softkey as a speed dial (see Section 4.12.4.1)

Softkey	Description
Speed Dial + BLF	Let's you configure a softkey as a speed dial + BLF (see Section 4.12.4.2)
Transfer (Trans)	Let's you perform an attended or semi-attended call transfer ³ (see Section 6.6).
Blind Transfer (BLXfer)	Let's you transfer a caller using the Blind Transfer mechanism ⁴ (see Section 6.6).
PSK	Instructs an application server to perform a specific action. For example, connect to voice mail or activate an intercom (see below). ⁵

³ This feature must first be enabled by the administrator.

⁴ This feature must first be enabled by the administrator.

⁵ This feature must first be enabled by the administrator.

4.12.3.1 Programmable Softkeys (PSKs)

When a Programmable softkey (PSK) is configured by the administrator, for example, connecting to a Voicemail server or accessing an intercom, you can be prompted to enter a personal code. The example below shows a softkey that has been assigned as a PSK to connect to a Voicemail server.



When you press the Voicemail softkey, you are prompted to enter a voicemail code:

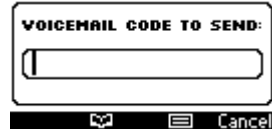

When you enter the voicemail code, you can press **Start** to dial to the Voicemail server, **Clear** to clear the entry or **Cancel**.

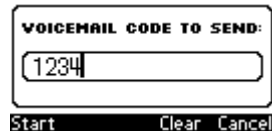

Note: PSKs can only be configured by the administrator. For more information, see the *Administrator's Manual*.

4.12.3.2 Configuring Softkeys

This section describes how to configure softkeys.

➤ **To configure softkeys:**

1. Do one of the following:
 - Configuring via Menu:
 - a. Access the Soft Keys screen (**MENU** key > **Keys Configuration** > **Soft Keys**):

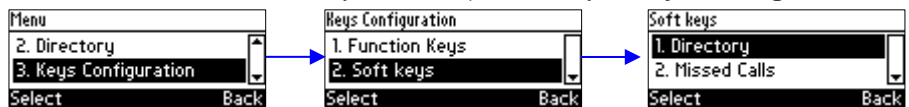

- b. Select **Directory**; the following screen is displayed:



The screen above indicates that softkey #1 is configured as Directory, i.e., .

- Configuring via Softkey
 - a. Long press any softkey.



Notes:

- The softkey button that is configured as a PSK and the 'More' button, when long pressed, do not open the softkey configuration mode.
- You can configure softkeys via the phone UI only in the Idle state.

2. Press the right or left rim of the navigation control button to navigate to the desired softkey:

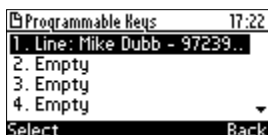

Or use the navigation control buttons to move to Navigate down to an Empty key and select it:



3. Press the navigation control's left or right rim to navigate to and select **Key Event**:

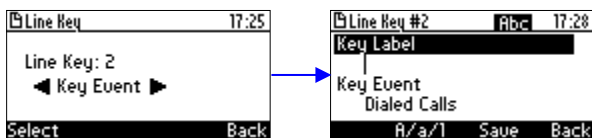

4. In the 'Key Label' field, define an identifier that you'll easily identify in the LCD, e.g., 'Dialed':

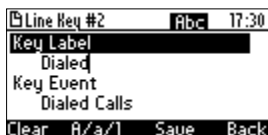

5. Navigate down to the 'Key Event' field and then press the navigation control's left or right rim to navigate to and select the Key Event you want to define, for example, 'Dialed Calls':

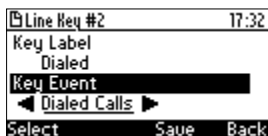

6. Press the **Save** softkey; the LCD reverts to idle mode displaying the 'Dialed' Key Event you defined ('Dialed', in this example):

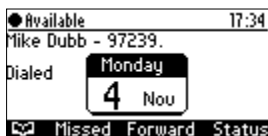

4.12.4 Deleting a Configured Softkey

This section shows how to delete a configured softkey.

➤ **To delete a configured softkey:**

1. Long-press the Programmable Key until this screen is displayed:

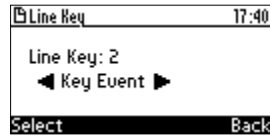

2. Press the navigation control's left or right rim to navigate to and select **Empty**; you're returned to the idle LCD; the Programmable Key is removed.

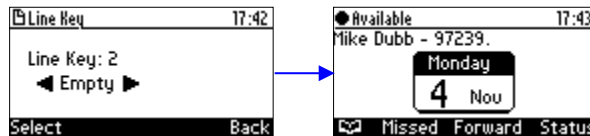

4.12.4.1 Configuring a Softkey for Speed Dialing

You can configure up to four softkeys as a Speed Dial.

➤ **To configure a softkey for Speed Dialing:**

1. Access the Soft Keys screen (**MENU** key > **Keys Configuration** > **Soft Keys**).
2. Select the softkey to configure as a Speed Dial, e.g., select the default **Directory** softkey.
3. Navigate to and select **Speed Dial** and then in the Soft Key # screen that opens, enter the telephone number to assign the speed dial to and press the **Save** softkey.

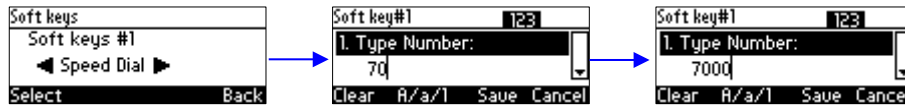

4. Press the **Back** softkey; view the Speed Dial (e.g., 7000) displayed in the Soft Keys screen and in the idle screen.

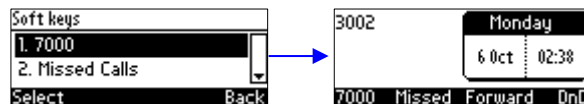

4.12.4.2 Configuring a Softkey as a Speed Dial + BLF

You can configure up to four softkeys as a Speed Dial + BLF.



Note: Speed Dial + BLF is presently supported for specific third parties only.

4.12.5 Configuring a Navigation Key Position Function

Each of the four positions of the navigation control button on the phone, i.e., Control Up, Control Down, Control Left, and Control Right, can be configured to perform one of the following five functions:

- None (default)
- Missed Calls
- Received Calls
- Dialed Calls
- All Calls
- Directory

➤ **To configure a navigation key position to perform a function:**

1. Access the Navigation Keys screen (**MENU** key > **Keys Configuration** > **Navigation Keys**):

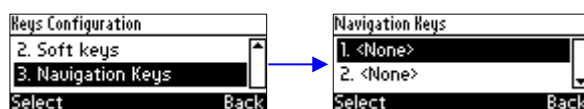

2. Press the **Select** softkey; the navigation key's Control Up position is displayed.

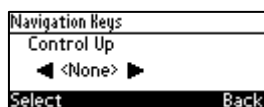

3. Navigate to and select the function you want to configure, e.g., **Missed Calls**. You can choose either **None** (default), **Missed Calls**, **Received Calls**, **Dialed Calls**, **All Calls**, or **Directory**.

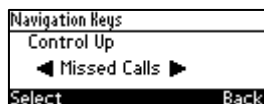

4. Press the **Select** softkey; the key position is now configured:

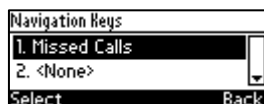

The user will be able to press the upper rim of the navigation control button on their phone in order to display Missed Calls on the phone's LCD screen.

5. To configure another navigation control button position as a function, navigate down to the next **<None>**, and then press the **Select** softkey; the Control Down navigation control button position opens:

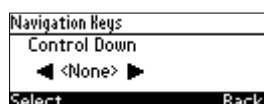

6. Navigate to and select the next function you want to configure, e.g., **Received Calls**.

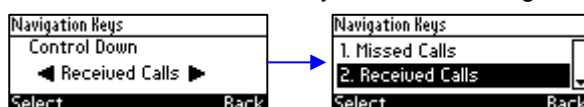

The user will be able to press the lower rim of the navigation control button on their phone in order to display Received Calls on the phone's LCD screen.

4.12.5.1 Removing a Configured Function

- **To remove a configured navigation control position function:**
 1. Navigate to and select the configured navigation control position function you want to delete (**Missed Calls**, **Received Calls**, **Dialed Calls**, **All Calls**, or **Directory**).
 2. Navigate to and select **<None>**; the function is removed.

This page is intentionally left blank.

5 Performing Basic Operations

This section shows how to perform basic phone operations.

5.1 Using Audio Devices

You can use one of the following audio devices on the phone for speaking and listening:

- **Handset:** To make a call or answer a call, lift the handset off the cradle.
- **Speaker** (hands-free mode). To activate it, press the speaker key during a call or when making a call. To deactivate it, press the speaker key again.
- **Headset** (hands-free mode). When talking on the phone, you can relay audio to a connected headset. To enable it, press the headset key. To disable it, press it again.

You can easily change audio device during a call.

- **To change from speaker/headset to handset:** Activate speaker/headset and pick up the handset; the speaker/headset is automatically disabled.
- **To change from handset to speaker/headset:** Off-hook the handset and press the speaker/headset key to activate the speaker/headset. Return the handset to the cradle; the speaker/headset remains activated.

5.2 Making Calls

The phone offers multiple ways of making a call. After dialing a number:

- LCD displays  and the called party's phone number or contact name if it's listed in the phone directory
- LCD displays the line extension number on which the called party is dialed
- The phone plays a ring-back tone

LCD indications:



- **To end dialing a call before it's answered:**
 - Press the **End** softkey or the speaker key.



Note:

- For advanced dialing using the phone directory, see Section 4.11 on page 36.
- For defining a speed dial key, see Section 4.12 on page 39.
- For using multiple lines, see Section 6.11 on page 64.

5.2.1 Dialing

You can dial in multiple ways. Either (1) key-in the number on the keypad or (2) press the speaker key and enter the number or (3) press the speaker key or lift the handset and press the **URL** softkey and enter host and domain name or IP address or alphabetical letters (e.g., tvservice).

➤ **To dial a regular-digits phone number:**

1. On the keypad, key the first digit of a regular phone number; the LCD displays the digit in the **NEW CALL** field; key in the remaining digits. To delete (from right to left) entered digits, press the **Clear** softkey. To cancel the call, press the **Cancel** softkey.



2. Press the **Dial** softkey (if you don't, dialling is automatically performed after a few seconds) or press the # (pound) key.

➤ **To dial a URL:**

1. Press the speaker key or lift the handset; the LCD displays the **NEW CALL** field and the **URL** softkey:



2. Press the **URL** softkey and enter a URL address, pressing the # key to toggle alphabetical letters and numerals (see Section 3.4 on page 23). To delete (from right to left) entered letters/numerals, press the **Clear** softkey. To cancel the call, press the **Cancel** softkey.



3. Press the **Dial** softkey.

5.2.2 Redialing

You can redial a number previously dialed.

➤ **To redial a number previously dialed:**

1. Press the **REDIAL** key on the phone; the Dialed Calls screen is displayed, listing in chronological order, recently dialed numbers:

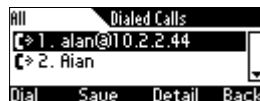

2. Navigate to the number to redial.
3. Press the **Dial** softkey or press the **OK** key on the phone's keypad.

5.2.3 Dialing a Missed Call

The phone logs all missed calls. The LCD in idle state displays the number of missed calls (if any):



➤ **To dial a missed call:**

1. Press the **Missed** softkey; the Missed Calls screen is displayed.



2. Navigate to the missed call to dial.
3. Press the **Dial** softkey or press the **OK** key on the phone.

5.3 Answering Calls

The phone indicates an incoming call as follows:

- LCD displays  together with the caller's phone number (or contact name if listed in the phone directory):



- Phone rings.
- Ring LED flashes blue.

➤ **To answer:**

- Pick up the handset -OR-
- Press the headset key (make sure the headset is connected to the phone) -OR- press the speaker key -OR- press the **Accept** softkey -OR- lift the handset:



Note: HD in the LCD indicates a high-definition call (using a wideband voice coder).

5.4 Rejecting Incoming Calls

You can reject an incoming call; the caller hears a busy tone from your phone if you do.

➤ **To reject an incoming call:**

- Press the **Reject** softkey.



5.5 Silencing Incoming Calls

You can silence an incoming call's ringing. If you do, the *caller* hears normal ringing but no answer.

➤ **To silence the ringing of an incoming call:**

- Press the **Silence** softkey.



Answer a silenced call by pressing the **Accept** softkey or picking up the handset.

5.6 Ending an Established Call

You can end an established call.

➤ **To end an established call:**

- Return the handset to the phone cradle if it was used to take the call -OR-
- Press the headset key -OR-
- Press the speaker key -OR-
- Press the **End** softkey

5.7 Viewing Missed, Received and Dialed Calls

Your phone logs missed, received and dialed calls. In idle state, the LCD displays the number of missed calls (if any) above the **Missed** softkey:

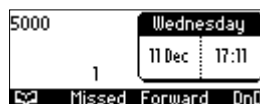

➤ **To view missed calls:**

- Press the **Missed** softkey; the Missed Calls screen is displayed.



Note: After pressing the **Missed** softkey, the indication disappears from the screen.

➤ **To view call history:**

1. Access the **Call Log** screen (**MENU** key > **Call Log**).

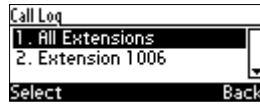

2. Select a specific extension or **All Extensions**; this screen opens:

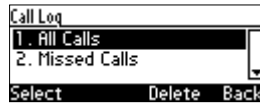

All Calls = calls that were missed, received and dialed

Missed Calls = calls that were not answered

Received Calls = the most recently answered numbers

Dialed Calls = the most recently dialed numbers

3. Navigate to the option you want and press the **Select** softkey; a list of the logged calls is displayed, for example, Missed Calls:



If multiple missed calls were from the same caller, the count is shown in parenthesis adjacent to the caller's name. In the above example, (3) missed calls were from Alan.

4. Press the softkey you need:

Dial = dials the number of the selected logged entry.

Save = saves the related information about the call entry in the personal directory (for adding a contact in the directory, see Section 4.11 on page 36).

Detail = accesses the Call Details screen, which displays details of the call entry:

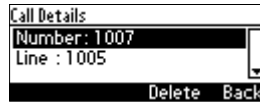

The Call Details screen displays the following logged call information:

Number = phone number logged

Time = the time the call was logged

Date = the date on which the call was logged

Duration = the duration of the call



Note:

- The call history lists are stored from the newest to oldest entries. The maximum number of entries for each call history type is 200. Once this maximum is attained, the oldest entry is deleted and replaced with the new entry.
- The call history lists are saved on a daily basis. In the case of a power outage, some of the received information may be lost.
- If you view missed calls by pressing the **Missed** softkey, the missed calls notification no longer appears on the screen and reappears the next missed call.

This page is intentionally left blank.

6 Performing Advanced Operations

This section shows how to perform advanced operations.

6.1 Answering Waiting Calls

You can accept a call on an extension on which there already is an active call.

Example:

a. A call with A is in progress on LINE 1

 = call in progress

b. A call comes in from B

 = call waiting

➤ **To answer B:**

1. Press the **Accept** softkey; the  icon is displayed indicating that the waiting call from **B** is answered; the previous call from **A** is put on hold:
2. To toggle between the calls, press the navigation control's upper or lower rim.



Note: To enable / disable the call waiting feature, see Section 4.3 on page 28.

6.2 Placing Calls On Hold

You can place a call on hold in order to answer a second incoming call (see Section 6.1 on page 55) or to make another call.

➤ **To place a call on hold:**

- Accept an incoming call and then press the **HOLD** key; the call is put on hold:



➤ **To retrieve a call on hold:**

- Press the **HOLD** key again -OR- press the **Resume** softkey.

6.3 Calling a Contact Listed in the Directory

You can call a contact listed in your directory.

➤ **To call a contact listed in your directory:**

1. Press the **CONTACTS** key on the phone and then press the **Select** softkey to access the directory.
2. Navigate to the contact to call (see also Section 4.11.5 on page 38).

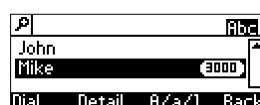

3. Press the **Dial** softkey or the **OK** key on the phone.

6.4 Enabling Auto Redial

If a called party is unavailable because, for example, they're busy, the caller's phone's LCD prompts **Extension Busy. Activate auto redial on busy?**



If the caller presses the **Yes** softkey to the prompt, the busy extension is automatically redialed every *n* seconds (configurable by the caller). The caller can stop the redialing at any time.



Note: Contact your network administrator to enable the feature if it is disabled (default).

When activated, **Dialing <ext> within <x>s** is indicated in the LCD (remote extension and timer). If activated in Multiple Line mode, **(Line <n>)** (line number) is also indicated in the LCD.



Pressing the **Dial** softkey redials the extension. Pressing the **Cancel** softkey deactivates auto-redial.



Note:

- Calls can be made and received while auto-redial is activated.
- If auto-redial is activated while another extension is called - which is also unavailable - the caller is prompted to activate auto-redial on the new (busy) extension; the previous auto-redial is then deactivated.
- If auto-redial is activated on an unavailable extension and on that same extension an incoming call is answered, the feature is deactivated.

➤ **To change the redial interval:**

1. Open the 'Automatic redial' screen in the phone LCD (**MENU > Settings > Automatic Redial**).

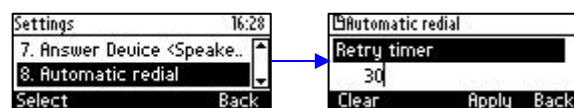

2. Enter the interval you require and then press the **Apply** softkey.

6.5 Pressing a Speed Dial Key to Make a Call

You can press a Speed Dial key (1-9 on the phone's keypad) to make a call. See under Section 4.12 for details on how to define a Speed Dial key.

➤ **To use a Speed Dial key:**

- Press a Speed Dial key 1-9 that you already defined; the phone automatically dials and calls the defined phone number.



Note: If you long-press a key that you have not defined as a Speed Dial, the Speed Dial #8 screen opens to let you define one.

6.6 Transferring Calls

You can connect a party with whom you're in a call, to another party. This is called transferring a call. Call transfers can be attended, semi-attended, or blind.

Transfer Method	When
Attended	A transfers caller B to C after caller C agrees to take the call from A.
Semi-attended	A transfers caller B to C before caller C answers the phone.
Blind	A sends a signal to B to refer the call to C.

See the following sections for details on each.

6.6.1 Performing an Attended Transfer

You can perform an attended transfer using the **Trans** softkey or the TRANSFER key.



Note: The **Trans** softkey is not available by default on the phone and must be configured in the configuration file. For more information, see the *Administrator's Manual*.

➤ **To perform an attended transfer:**

1. Anat (2450) receives a call from Brad (2460):



2. Anat answers the call from Brad:



3. Anat uses one of the following methods to transfer the call to a third-party destination:

- Selects the **Trans.** softkey (use the **More** button to navigate to it if required)
- OR
- Presses the TRANSFER key on the phone.



Music on Hold is played to Brad.

4. The requested third-party destination extension 2440 to transfer the call is entered:



5. The **Dial** softkey is pressed:

The requested extension 2440 is dialed:



The call is connected to 2440:



6. After consulting with 2440, Anat presses the **Trans.** softkey or TRANSFER:

The call from Brad is transferred to 2440.

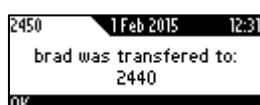

7. Anat presses **OK** and hangs up the phone.

6.6.2 Performing a Semi-Attended Transfer

You can perform a semi-attended transfer using the **Trans** softkey or the TRANSFER key.



Note: The **Trans** softkey is not available by default on the phone and must be configured in the configuration file. For more information, see the *Administrator's Manual*.

➤ **To perform a semi-attended transfer:**

1. Anat (2450) receives a call from Brad (2460):



2. Anat answers the call from Brad:



3. Anat uses one of the following methods to transfer the call to a third-party destination:

- Selects the **Trans.** softkey (use the **More** button to navigate to it if required)
- OR
- Presses the TRANSFER key on the phone.



Music on Hold is played to Brad.

4. The requested third-party destination extension 2440 to transfer the call is entered:



5. Anat presses the **Dial** softkey to dial the extension 2440.

The requested extension 2440 is dialed:



6. Anat waits for a dial tone and then presses the **Trans.** softkey or TRANSFER.

The call from Brad is transferred to 2440:

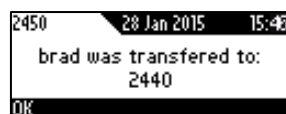

7. Anat presses **OK** and hangs up the phone before 2440 answers.

6.6.3 Performing a Blind Transfer

This section describes how to perform a blind transfer using the **BLXfer** softkey.



Note: The **BLXfer** softkey is not available by default on the phone and must be configured in the configuration file. For more information, see the *Administrator's Manual*.

➤ **To perform a blind transfer:**

1. Anat (2450) receives a call from Brad (2460):



2. Anat answers the call from Brad:



3. Anat transfers the call by selecting the **Blind Transfer (BLXfer)** softkey (use the **More** button to navigate to it if required):



4. The requested extension 2440 to which to transfer the call is entered:



5. The extension 2440 is dialed:



6. Anat presses the **Trans.** softkey and hangs up the phone before waiting for a dial tone.

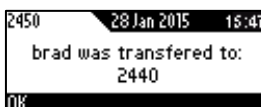

The call from Brad is transferred to 2440 and Brad hears the requested transfer destination party 2440 ringing.

6.7 Hosting 3-Way Conference Calls

You can make a 3-way conference call with two other parties.

➤ **To make a 3-way conference call:**

1. Call the first participant (**M**); the call is established:
2. Press the **Conf** softkey; the CONFERENCE WITH...screen is displayed.
3. Enter the number of a second participant, and then press the **Dial** softkey. When the second participant answers, a call is established.
4. Press the **Conf** softkey again; a 3-way conference call is established and the names of all participants are displayed on the screen.
5. To end the conference call, hang up the phone or press the **End** softkey.

6.7.1 Leaving a 3-Way Conference You Set up without Disconnecting the Others

A caller who sets up a three-way conference call with two other parties can leave it without disconnecting the two other parties. The two others continue uninterrupted. The 'Drop from Conference' feature supports this capability.

➤ **To leave a conference you set up, without disconnecting the other parties:**

- Press the **Transfer** softkey; you're disconnected from the conference; the two remaining parties continue unaffected.



Note: The initiator of a call conference can also drop out of the conference by on-hooking the phone, without disrupting parties B and C. In a conference call initiated by user A with participants B and C, user A can on-hook to drop out, and B and C can continue talking uninterruptedly.

6.8 Muting Calls

You can mute the microphone of the handset, headset, or speakerphone during a call so that the other party cannot hear you. While the call is muted you can still hear the other party. Muting calls can also be used during conference calls.

➤ **To mute/unmute a call:**

1. During a call, press the **MUTE** key.
2. To unmute, press the **MUTE** key again and resume the conversation.

6.9 Activating Do Not Disturb

The DnD feature stops the phone from ringing when others call you. If DnD is activated when someone calls you:

- The caller hears a tone indicating that your phone is busy.
- The call is blocked and the idle screen indicates 'Missed Calls'.

➤ To activate DnD:

1. Ensure that your phone is in idle state and that the idle screen is displayed, i.e., that you're not in an active call or dialing a number.
2. Press the **DnD** softkey and select **All Extensions** or a specific line on which to activate DnD, and press the **Select** softkey; the screen displays an icon Θ adjacent to the extension line/s indicating that incoming calls on them are blocked:



➤ To deactivate DnD:

1. Ensure that the phone is in idle state and that the idle screen is displayed, i.e., that you're not in an active call or dialing a number.
2. Press the **DnD** softkey and select **All Extensions** or the specific line to deactivate, and press the **Select** softkey; the Θ icon is no longer displayed on the screen and your phone now rings for incoming calls.

6.10 Retrieving Voice Mail Messages

You can listen to voice mail messages. You can tell you have voice mail when (1) an envelope icon is displayed in the phone's idle screen (see the screen below), (2) the Ring LED on the phone is permanently lit blue (see [Figure 2-1](#), label 1), and (3) a stutter dial tone is heard when you pick up the handset.



➤ To listen to voice mail messages:

1. Press the **VOICE MAIL** key:

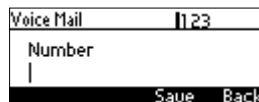

2. Enter the number the VOICEMAIL box phone number; the phone dials your VOICEMAIL box. Follow the instructions of your voice mail provider.



Note: If the VOICEMAIL number has not been configured by your administrator then after pressing the **VOICEMAIL** key, enter it and press the **Save** softkey. Press the **VOICEMAIL** key again to listen to voice messages.

6.11 Using Two Lines

Your phone supports up to two lines. Each is configured with its own extension number. The figure below shows the idle screen of a phone set up with two lines whose extension numbers are **5000** and **7000**.



Note: Only your network administrator can configure the two lines. See the *Administrator's Manual* for details.

6.11.1 Choosing an Extension Line

You can select a line to use. The screen displays a bar above the extension number of the line currently being used (see 5000 in the figure above). Until changed, all new calls are made on it.

➤ **To change lines:**

1. Ensure that the LCD is in idle state and that no calls are established. View the two configured lines displayed in the screen. View the bar above the currently used line.
2. Navigate to and select the other line; the bar moves above it; all new calls will now be made on it.

6.11.2 Making a Call on an Extension Line

You can make a call on an extension line.

➤ **To make a call on an extension line:**

1. When the screen is in idle state, raise the handset or press the key of the first digit of the number to call; the NEW CALL screen is displayed:



2. Enter the number of the person to call or press the  softkey to select a contact from the Directory and press the **Dial** softkey; the dialed number is called and the line on which the call is made is indicated in the screen.



When the called party answers, this screen appears:



6.11.3 Making Two Calls on a Line

Up to two calls per line can be made.

➤ **To make two calls on a line:**

1. Make a call on a line, for example, call **M**. After establishing this call, press the **NEW CALL** softkey; the call with **M** is automatically put on hold and the **NEW CALL** screen is displayed.
2. Enter the phone number of a second party (**A**) or press the  softkey to select their entry in the directory and press the **Dial** softkey.
A answers.
3. To toggle between **M** (on hold) and **A**, press the navigation control's upper and lower rim (see Section 6.11.6 on page 66).

6.11.4 Making Multiple Line Calls

Your phone supports multiple line calls. Two extension lines, defined by your administrator, are supported. Two calls can run simultaneously on each extension line. You can therefore have up to four calls running on your phone simultaneously, where one is active and three are on hold.

Example scenario:

1. Extension line 1000 calls **M**
2. Extension line 2000 calls **A**

➤ **To make a multiple line call:**

1. When the screen is in idle state, navigate to and select the required line, e.g., 1000.
2. Lift the handset; the **NEW CALL** screen appears.
3. In the **NEW CALL** screen, enter the phone number or press the  softkey to select a contact from your directory, e.g., **M**, whose number is 3000.
4. Press the **Dial** softkey.
M answers.
5. Press the **NEW CALL** softkey; the currently active call with **M** is automatically put on hold and you're prompted to enter a phone number or select a contact.
6. Before doing this, press the navigation control's *left* or *right* rim to navigate to line 2000.
7. Make another call exactly like you made the first call to **M** (on hold) but on line 2000: Enter a phone number or select a contact, e.g., **A**, and press the **Dial** softkey; **A** answers.
8. To toggle between **M** (on hold on line **1000**) and **A** (active on line **2000**), press the navigation control's upper and lower rim (see below).

6.11.5 Toggling Between Multiple-Line Calls

After making calls on two different lines, you can toggle between them. When using two lines, one line is active while the other is on hold. Toggling between lines therefore involves putting the currently active call on hold and resuming the previously held call.

The  icon indicates an active line.

The " " icon indicates a call that has been put on hold.

➤ **To toggle between multiple-line calls:**

- Press the navigation control's upper or lower rim to select the conversation to resume and press the **Resume** softkey.

6.11.6 Toggling Between Calls on the Same Line

You can toggle between two calls on the same line. How you toggle depends on whether the first-placed call is active or the second-placed call is active.

➤ **To toggle from the first-placed call to the second-placed call:**

- Press the navigation control's upper or lower rim to select the second-placed call and then press the **Resume** softkey; the first-placed call is automatically put on hold.

➤ **To toggle from the second-placed call to the first-placed call:**

- Press the navigation control's upper or lower rim to select the first-placed call and then press the **Resume** softkey; the second-placed call is automatically put on hold.

6.11.7 Answering Calls

You can answer an incoming call on a line extension.

➤ **To answer an incoming call on a line extension:**

- View the oncoming call indication on the screen.
- Press the **Accept** softkey or lift the handset; the call is answered and all other calls are put on hold.

6.11.8 Ending Calls

You can only end calls that are active, i.e., not on hold.

➤ **To end an active call:**

1. Ensure that the call is active and not on hold.
2. Press the **End** softkey or the **SPEAKER** key.

6.12 Logging into a Remote HTTP/S Server

When you attempt to download a new configuration file from the Provisioning server, you can optionally be prompted to enter the Provisioning server login credentials (username and password). This feature is useful when, for example, you are provisioning, and attempt to download a configuration file from a Provisioning server. In which case, the server's authentication process recognizes that an http username and/or password has not been specified or that these credentials are incorrect. In this case, when this feature is enabled, the 'Prov. Credentials' screen pops up, prompting you to enter or reenter these login credentials.



Note: This feature is only available when the 'ui_interaction_enabled' parameter is enabled. For more information, see the *Administrator's Manual*. When this parameter is not enabled, then the 'Prov. Credentials' option does not appear in the Settings menu on the phone.

You can also manually set the remote server login credentials.

➤ **To manually set remote server login credentials:**

1. In the Prov. Credentials screen (**MENU** key > **Settings** > **Prov. Credentials**):

```
Prov. credentials  [signal] 18:00
User name
  brad
Password
Clear  A/a/1  OK  Skip
```

2. At the prompt, enter the HTTP/S username.
3. At the prompt, enter the HTTP/S password.
4. Press the **OK** softkey to confirm, press the **Clear** softkey to clear the entered characters or press the **Skip** softkey to return to the previous menu.

7 Troubleshooting

Read this section if a problem with your phone occurs. If the section does not facilitate resolving the issue, contact your system administrator.

Table 7-1: Troubleshooting

Symptom	Problem	Corrective Procedure
Phone is off (no LCD displays and LEDs)	Phone is not receiving power	<ul style="list-style-type: none"> Verify that the AC/DC power adapter is attached firmly to the DC input on the rear of the phone. Verify that the AC/DC power adapter is plugged into the electrical outlet. Verify that the electrical outlet is functional. If using Power over Ethernet (PoE), contact your system administrator to check that the switch is supplying power to the phone.
'LAN Link Failure' message displayed on the LCD	No LAN connection	<ul style="list-style-type: none"> Verify that the LAN cable is connected securely to the LAN port on the rear of the phone. Verify that the other end of the LAN cable is connected to the network (switch). If it's not, inform your system administrator.
Phone is not ringing	Ring volume is set too low	<ul style="list-style-type: none"> Increase the volume (see Section 4.9.1)
'Registration...' message displayed on the LCD and calls cannot be made or received	Line not registered to network	If your phone has multiple lines and an 'X' is displayed on the LCD for a line, this indicates that the line has not been successfully registered. For assistance, contact your system administrator.
LCD display is poor	LCD settings	<ul style="list-style-type: none"> Adjust the phone's screen contrast level (see Section 4.5) Adjust the screen's backlight timeout (see Section 4.6)
Headset has no audio	Headset not connected properly	<ul style="list-style-type: none"> Verify that your headset is securely plugged into the headset port located on the side of the phone. Verify that the headset volume level is adjusted adequately (see Section 4.9.5).
IP Duplication	Duplicate IP address conflict can occur on a DHCP network if you defined a static IP address for a network device	<ul style="list-style-type: none"> Convert the network device with the static IP address to a DHCP client -OR- Exclude the static IP address from the DHCP scope on the DHCP server

This page is intentionally left blank.

