



PureConnect®

2023 R1

Generated:

08-February-2023

Content last updated:

14-June-2019

See [Change Log](#) for summary of changes.



MRCP

Technical Reference

Abstract

This document discusses PureConnect's implementation of Media Resource Control Protocol (MRCP), including protocol flow architecture and CIC integration.

For the latest version of this document, see the PureConnect Documentation Library at: <http://help.genesys.com/pureconnect>.

For copyright and trademark information, see https://help.genesys.com/pureconnect/desktop/copyright_and_trademark_information.htm.

Table of Contents

Table of Contents	2
About the MRCP Technical Reference	3
Referenced information	3
Introduction to MRCP	4
Overview	4
CIC support for MRCP	5
MRCP for TTS	5
MRCP for ASR	5
Architecture	5
Installation and configuration	7
Hardware considerations	7
Install the MRCP server	7
Server selection	8
MRCP capabilities	8
Probation	9
Locations and Selection Rules	10
MRCP selection rules	10
Default MRCP Selection Rules	10
Default scenarios	10
Custom MRCP Selection Rules	12
Custom scenarios	12
Priority	14
Load balancing	14
Add an MRCP server	15
Assign an MRCP server to a Location	17
Assign MRCP Selection Rules to a Location	19
Alternative method for assigning an MRCP server to a Location	20
Configure an MRCP server for Text to Speech	21
Test a TTS MRCP server installation	25
Configure CIC to use MRCP server for all Text to Speech	26
Change MRCP connection timeout	27
Check Windows Event Viewer for probation warnings	28
Deactivate an MRCP server	29
Reactivate an MRCP server	30
Interaction Designer for TTS	31
MRCP with SAPI	32
MRCP optional parameters	33
Frequently asked questions	35
Change log	36

About the MRCP Technical Reference

The *MRCP Technical Reference* is for CIC System administrators, business partners, and those who want to understand the purpose, concepts, and architecture of the PureConnect MRCP implementation for Customer Interaction Center.

Referenced information

Because MRCP is integrated with CIC, there are additional technical references and guides that might be of interest to you. This information is available in the PureConnect Documentation Library on your CIC server or <http://help.genesys.com/cic>.

The following documents, Help systems, and links are referred to in the *MRCP Technical Reference* and provide additional MRCP information:

- [*CIC Installation and Configuration Guide*](#)
- [*VoiceXML Technical Reference*](#)
- [*PureConnect Security Features Technical Reference*](#)
- [*Automated Speech Recognition Technical Reference*](#)
- [*Interaction Media Server Technical Reference*](#)
- [*Interaction Speech Recognition Technical Reference*](#)
- [*CIC Text to Speech Engines Technical Reference*](#)
- [*Interaction Administrator Help*](#)
- [*Interaction Designer Help*](#)
- [*PureConnect Activation File Management Tool*](#)

You can also find information on the Internet Engineering Task Force website at the following address:
<http://tools.ietf.org/html/rfc6787>

Introduction to MRCP

Speech-related clients, such as a VoiceXML browser, use Media Resource Control Protocol (MRCP) to control media service resources, including Text-to-Speech (TTS) synthesizers and Automatic Speech Recognizers (ASR). Customer Interaction Center (CIC) supports MRCP version 2 (MRCPv2), which is the current standard.

To connect clients with speech processing servers and manage the sessions between them, MRCP relies on other protocols, such as Session Initiation Protocol (SIP). MRCP uses SIP to set up and tear down media and control sessions with the speech server. Furthermore, MRCP defines the messages to control the media service resources and it also defines the messages that provide the status of the media service resources.

Overview

Media Resource Control Protocol (MRCP) is a standard proposed by the Internet Engineering Task Force (IETF) for controlling media services for resources such as speech synthesizers, recognizers, recorders, and verifiers residing on servers on the network. The current standard is now in version 2, which is the only version supported by Customer Interaction Center.

MRCP is an application layer protocol and relies on another session management protocol, typically Session Initiation Protocol (SIP), to establish a control session between the client and the server. SIP is used to establish not only the control channel to use for MRCP, but also to establish the media sessions and associated parameters between the media source—or sink—and the media server.

Once established, the MRCP protocol exchange operates over the control session, allowing the client to control the media processing resources on the speech resource server.

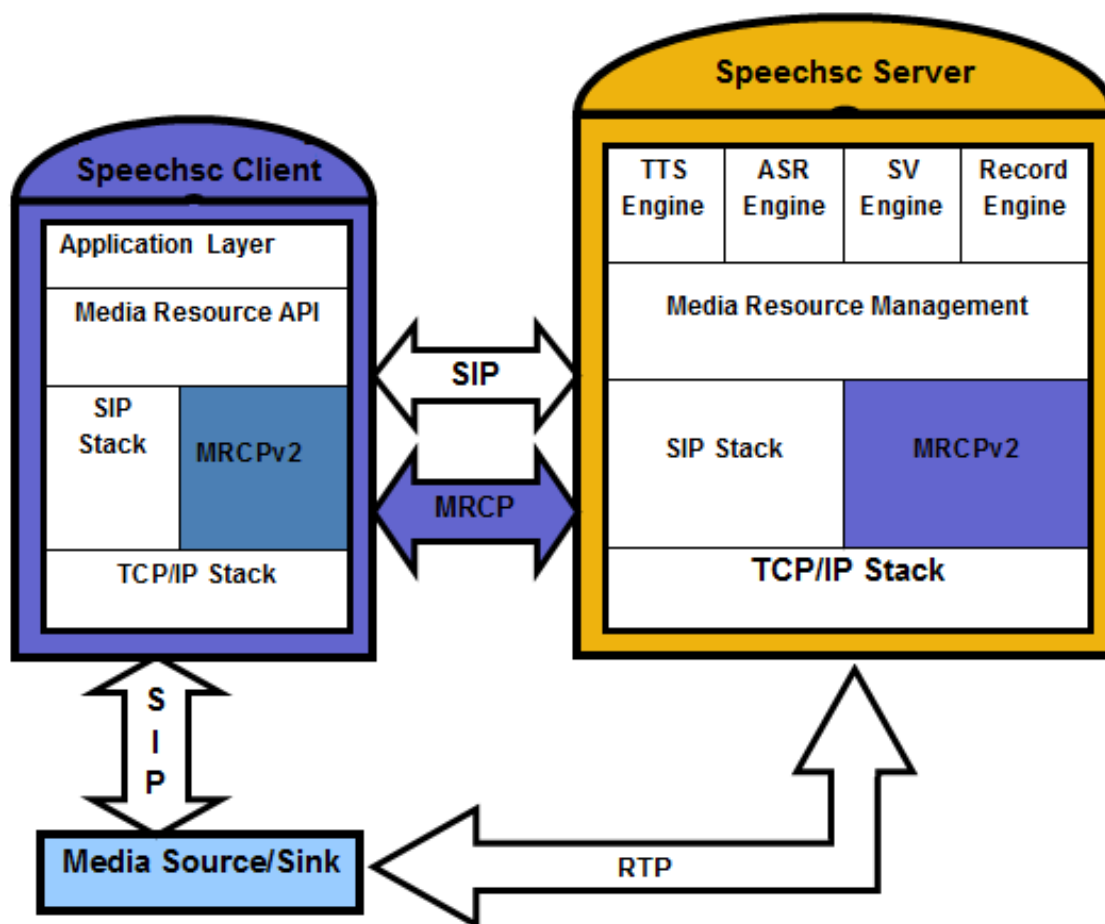

CIC support for MRCP

CIC supports MRCP for Text-to-Speech (TTS) and Automatic Speech Recognition (ASR) functionality.

MRCP for TTS

MRCP in CIC supports synthesizer resources, and it is intended as an alternative to using SAPI for TTS. The following list lists some advantages of using MRCP for TTS.

- TTS processing is off-loaded to other servers rather than competing for resources on the CIC server.
- The MRCP subsystem provides load-balancing capabilities between servers.
- The MRCPv2 standard is much more transparent than SAPI, and it is not based on Component Object Model (COM).
- Most speech vendors have implemented MRCP and deprecated their SAPI integration.
- Audio is streamed from MRCP Servers using Real-time Transport Protocol (RTP) rather than a proprietary method.
- Support for multiple languages, voices, and, vendors are more efficient with MRCP.
- Interaction Text to Speech is a native TTS engine in Interaction Media Server and can use MRCP. For more information on Interaction Text to Speech, see [CIC Text to Speech Engines Technical Reference](#) in the [PureConnect Documentation Library](#).

CIC can use MRCP TTS in the following instances:

Function	Description
Name prompt generation	System handlers will use TTS if there are user name prompts that have not been recorded.
Telephone User Interface (TUI) and Mobile Office	The TUI and Mobile Office will use TTS for dynamic prompts and for email playback.
Handlers	Whenever TTS prompt tools such as Play String, Play Text File, Record String, Record Text File, and Play Prompt Phrase tools—and anytime their extended versions are used.
VoiceXML	TTS prompts in VoiceXML scripts can use MRCP.
Interaction Desktop Personal Rules	Personal Rules, configured in Interaction Desktop, can take advantage of TTS.

MRCP for ASR

The following list provides some of the advantages of using MRCP for ASR.

- Some speech vendors allow only MRCP integrations.
- The MRCP standard allows CIC to integrate with new ASR vendors.
- The MRCP standard is much more transparent than proprietary Application Programming Interfaces (APIs) that are used with other PureConnect ASR server implementations.

CIC can use MRCP ASR in the following instances:

Function	Description
TUI and Mobile Office	The TUI and Mobile Office will use ASR for recognizing callers' utterances.
Handlers	Whenever ASR recognition tools are used, such as Reco Input.
VoiceXML	ASR inputs in VoiceXML scripts can use MRCP.

Note:

Note:

For more information on MRCP for ASR, see [ASR Technical Reference](#) in the [PureConnect Documentation Library](#).

Architecture

The following diagram depicts the protocol flow between servers using MRCP and illustrates how a third-party TTS MRCP play occurs. In this flow, all audio is streamed from the MRCP Server directly to Interaction Media Server using RTP. The audio is then

streamed directly to the endpoint using RTP.

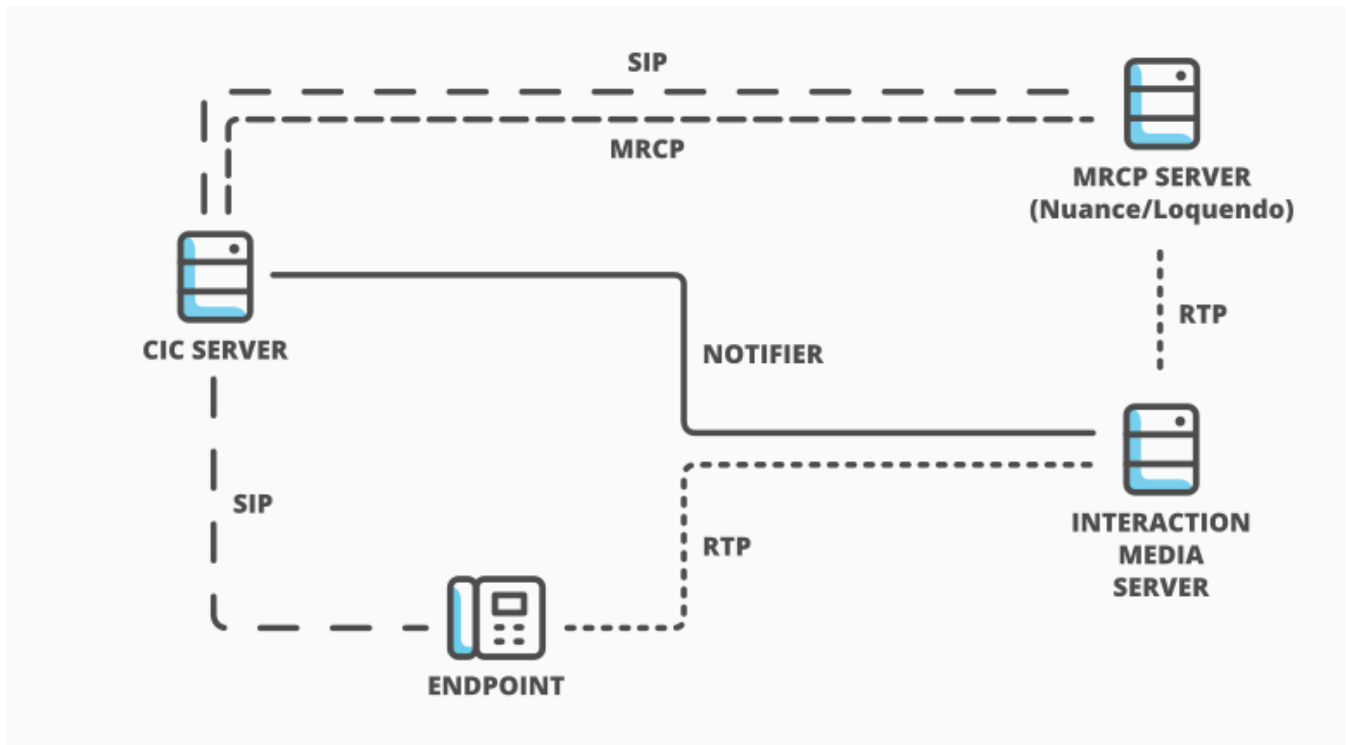

CIC MRCP Architecture (third-party TTS)



The following diagram depicts the protocol flow between servers using MRCP with Interaction Text to Speech, which is a part of Interaction Media Server. In this flow, all audio is streamed from Interaction Media Server to the endpoint using RTP.

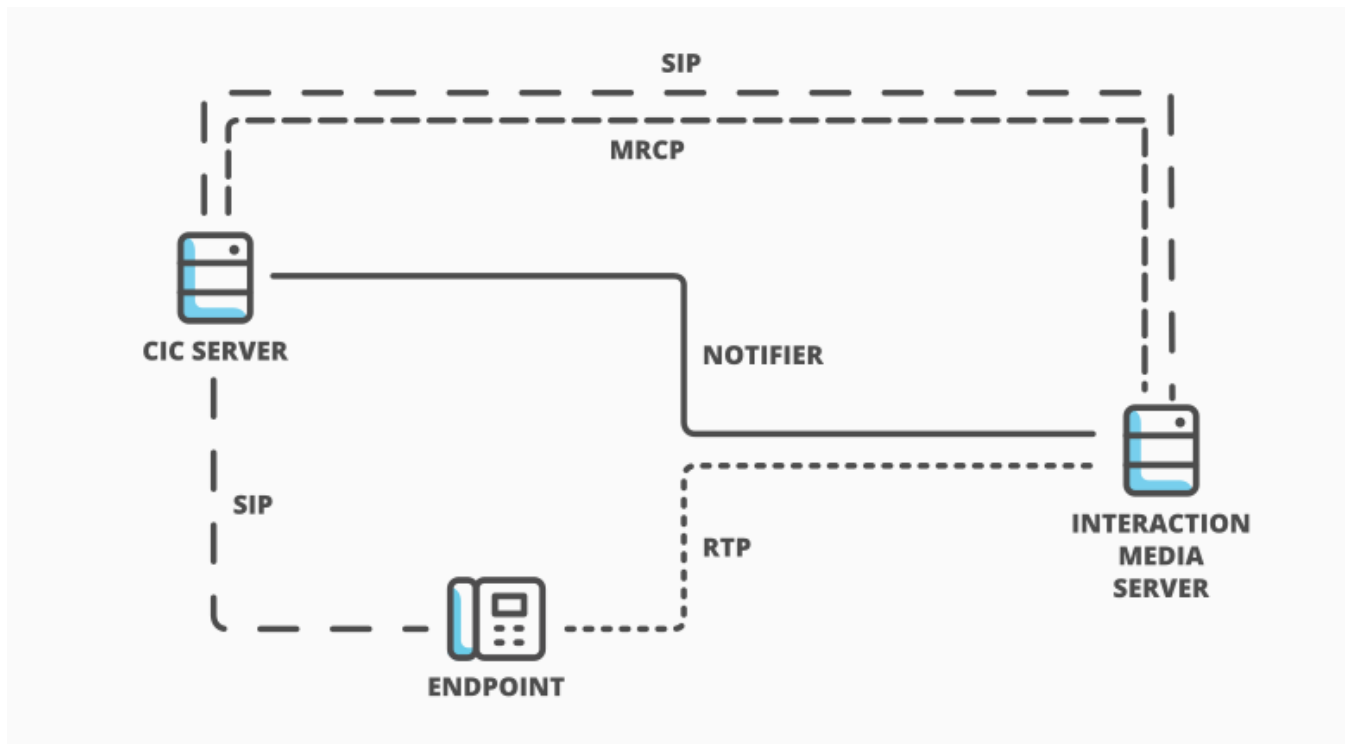

CIC MRCP Architecture (Interaction Text to Speech)



Installation and configuration

An MRCP installation includes the following tasks:

- Set up a third-party MRCP server
- Configure the Customer Interaction Center server to use the MRCP server

Hardware considerations

Because MRCP servers are media intensive, you must use a dedicated server to run third-party MRCP server software in your CIC environment. Genesys recommends that the MRCP server have ample processing speed and physical memory. Because audio streams between the MRCP server and Interaction Media Servers using RTP, Genesys also recommends that the MRCP server be in the same subnet and have a high bandwidth connection to Interaction Media Servers in the same region.

Using Interaction Text to Speech, which is a part of Interaction Media Server, requires significant resources and could impact the performance of Interaction Media Servers that already used a significant amount of resources for previous levels of media operations.

Install the MRCP server

Note:

Interaction Text to Speech is a native TTS engine within Interaction Media Server and does not require a separate installation. You still must apply Interaction Text to Speech licenses through Interaction Administrator. For more information on Interaction Text to Speech, see [CIC Text to Speech Engines Technical Reference](#) in the [PureConnect Documentation Library](#).

Follow the installation instructions from the vendor of your third-party MRCP server. Ensure that the MRCP server media includes the MRCP server installer and installers for the MRCP resources being used. For example, if MRCP is being used for TTS, both an MRCP server installer and a TTS engine installer are required.

CIC supports the following third-party MRCP servers:

- Nuance Speech Server
- Loquendo Speech Suite Server

For the most current versions of the supported third-party MRCP servers with CIC, see the following website:

<http://testlab.genesys.com>

Server selection

When fulfilling a request for MRCP services, CIC analyzes the following items to choose an MRCP server.

Order of Consideration	Selection Process	Description
1	MRCP Capabilities	CIC searches for MRCP servers that provide the requested MRCP capabilities.
2	Probation	CIC searches for MRCP servers that are not on probation. CIC will use any server that is not on probation and has the requested MRCP capabilities before a server on probation—even if the server on probation has a better Location, lower Priority, or fewer active sessions.
3	Location/Selection Rules	Using the Location and Selection Rules, CIC searches for MRCP servers that are in the best location to use the WAN most efficiently. Any MRCP server in a better Location that has the requested MRCP capabilities and is not on probation will be selected before a server with a lower Priority, or fewer sessions.
4	Priority	CIC searches for servers with a low priority number. Any MRCP server with a lower priority that has the requested MRCP capabilities, is not on probation, and in a better Location, will be selected before a server with fewer sessions.
5	Load Balancing	Once the other criteria are met, CIC searches for an MRCP server with the fewest sessions. In the case where more than one MRCP server meets the above criteria, CIC selects the MRCP server with the fewest sessions.

MRCP capabilities

The MRCP subsystem of the CIC server supports selecting a specific MRCP server to fulfil a Text-to-Speech (TTS) request based on the MRCP capabilities of the server. A request can contain the following criteria:

Criteria	Description
Server Name	Matches the name of a specific server—as its name is configured in Interaction Administrator.
MRCP Version	Matches servers that support a specific MRCP version—MRCPv2 by default.
Vendor	Matches the vendor field of a specific server.
Voice Name	Matches servers that support a specific voice name.
Voice Gender	Matches servers that support a specific voice gender.
Voice Language	Matches servers that support a specific language.

Probation

To improve the efficiency of the server selection process, the CIC server places an MRCP server on probation if it does not respond or if it fails to create the necessary resources for a call. When an MRCP server is on probation, the CIC server stops sending requests to that server for a set time period to minimize the impact of failures.

A CIC server puts an MRCP server on probation for the following reasons:

- An MRCP server does not respond within the configurable **Connection Timeout** period (Default value: 5 seconds) to a resource creation request from a CIC server.

The following list provides possible reasons:

- A networking issue between the CIC server and the MRCP server
 - The MRCP server or service is not running
 - The MRCP server has insufficient resources to respond in time
- An MRCP server responds with an error.
To diagnose the issues, check the MRCP server logs or contact PureConnect Customer Care. Common causes include the following items:
 - Configuration issues on the MRCP server.
This issue is particularly common if the MRCP server has never worked successfully or its configuration has recently changed. If this is the case, please review the installation procedure or contact Genesys Customer Care.
 - Running out of licenses on the MRCP server.
Purchase additional licenses for the MRCP server.

The duration of the first probation period is, by default, 5 seconds, which enables MRCP servers with minor problems to recover and rejoin the pool of available MRCP servers. However, each probation period doubles with each consecutive failure, up to a maximum probation period of 10 minutes.

Failure sequence	Probation period
First	5 seconds
Second	10 seconds
Third	20 seconds
Fourth	40 seconds
Fifth	1 minute 20 seconds
Sixth	2 minutes 40 seconds
Seventh	5 minutes 20 seconds
Eighth and up	10 minutes

Probation status does not remove an MRCP server from selection but it does move that MRCP server to the bottom of the list of available MRCP servers. If there are multiple MRCP servers on probation, the CIC server arranges those MRCP servers at the bottom of the selection list according to items 3 to 5 in the [Server selection](#) process. For example, MRCP servers on probation in a favorable location appear before servers on probation in an unfavorable location.

If all available MRCP servers are on probation or if you have only one MRCP server, the CIC server disregards the probation state and requests an MRCP server to handle the interaction.

Note:

Multiple CIC servers do not share probation state information. Each CIC server tracks MRCP server states separately. To change the **Connection Timeout** period, see [Change MRCP connection timeout](#) .

Locations and Selection Rules

The goal behind MRCP regionalization, through Locations and Selection Rules, is to ensure that the functions provided by the MRCP server occur in the most efficient manner possible. This system allows geographically-dispersed networks to provide the best performance as well as ensure the most efficient use of the available WAN bandwidth for MRCP resources.

Locations enables the correct application of Selection Rules. More specifically, when you assign an MRCP server to a Location, you are specifying where the server resides. When you set up Selection Rules, you are specifying the order of the Locations in which the system is to look for available servers when an Interaction Media Server is used for MRCP in a location. So, using information gleaned from the Location and Selection Rules, CIC finds the best place to use an MRCP server.

MRCP selection rules

When you assign an MRCP server to a location, Selection Rules can then consider that MRCP server. In many cases, the default MRCP Selection Rules provide sufficient functionality. However, you can assign custom MRCP Selection Rules to a location.

Note:

It is important to understand that the Interaction Media Server Selection Rules are always applied first and that they are performed independently, regardless of MRCP server availability.

For more information on Interaction Media Server Selection Rules, see [Interaction Media Server Technical Reference](#) in the [PureConnect Documentation Library](#).

Important!

For Interaction Text to Speech, the CIC server does not use MRCP Selection Rules. Instead, the CIC server uses the instances of Interaction Text to Speech on the Interaction Media Server that it selected through Media Server Selection Rules.

For more information, see the following:

- [Default MRCP Selection Rules](#)
- [Default scenarios](#)
- [Custom MRCP Selection Rules](#)
- [Custom scenarios](#)

Default MRCP Selection Rules

When you create a Location in Interaction Administrator, CIC automatically assigns the Default MRCP Selection Rules to that Location. This default configuration specifies a logical order of Locations that will provide the best possible connection to an available MRCP server. The default Selection Rules specify that the CIC server searches for and selects an available MRCP server using the following order:

<ThisLocation>	The Location where the media server for the call exists.
<ICServerLocation>	The location that has the CIC server that controls the interaction.
<Any>	This option directs the CIC server to search any defined Location in the network if it cannot find an available MRCP server at the above locations.

Default scenarios

Note:

These scenarios represent only some of the possibilities for MRCP Selection Rules and are intended to only highlight how Default MRCP Selection Rule functions.

Default MRCP Selection Rules work without requiring modification in many cases. Assume the following configuration where Interaction Media Servers use Default Media Server Selection Rules:

Seattle	Indianapolis	Orlando
Media gateway	Media gateway	Media gateway
Media server	CIC server	Media server
MRCP server	Media server	MRCP server
	MRCP server	

A call enters the Orlando Location, which would start the events in one of the following scenarios:

Scenario 1

- The CIC server checks the first entry in Default Media Server Selection Rule assigned to the Orlando Location: <This Location>.
- If an Interaction Media Server is available in Orlando, the CIC server uses it for the call.
- The CIC server checks the first entry in Default MRCP Selection Rule assigned to the Orlando Location: <This Location>.
- If an MRCP server is available in the Orlando Location and not on probation, the CIC server uses it for media operations in the call.

Analysis: This scenario represents the best case scenario as all audio remains in the Orlando Location where it will likely have the best quality. The Default MRCP Selection Rule always uses this scenario, if possible.

Scenario 2

- The CIC server checks the first entry in Default Media Server Selection Rule assigned to the Orlando Location: <This Location>.
- If an Interaction Media Server is not available in Orlando, then the CIC server checks the second entry in Default Media Server Selection Rule: <ICServerLocation>.
- If an Interaction Media Server is available in the Indianapolis Location, the CIC server uses it for the call.
- Since the Interaction Media Server handling the call is in the Indianapolis Location, the CIC server checks the first entry in Default MRCP Selection Rule assigned to the Indianapolis Location: <This Location>.
- If an MRCP server is available in the Indianapolis Location *and not on probation*, the CIC server uses it for media operations in the call.

Note:

This scenario demonstrates how the <ThisLocation> entry in the Default MRCP Selection Rules provides the best possible result. Using both an Interaction Media Server and an MRCP server in the Indianapolis Location ensures that no audio is set over another WAN connection.

Scenario 3

- The CIC server checks the first entry in Default Media Server Selection Rule assigned to the Orlando Location: <This Location>.
- If an Interaction Media Server is available in the Orlando Location, the CIC server uses it for the call.
- The CIC server checks the first entry in Default MRCP Selection Rule assigned to the Orlando Location: <This Location>.
- If an MRCP server is not available in the Orlando Location, the CIC server checks the second entry in Default MRCP Selection Rule: <ICServerLocation>.
- If an MRCP server is available in the Indianapolis Location and not on probation, the CIC server uses it for media operations in the call.

Analysis:

This scenario demonstrates how the <ICServerLocation> entry in the Default MRCP Selection Rules provides the best possible result. Because the MRCP server in the Orlando Location is unavailable, the Interaction Media Server sends audio from the Orlando Location to an MRCP server in the Indianapolis Location. The WAN connection of the Location with the CIC server is likely better than other WAN connections. Additionally, the CIC server applies the Default Media Server Selection Rule first and independently from the Default MRCP Selection Rule.

While selecting an Interaction Media Server in the Indianapolis Location might seem better for this scenario, understand that the audio must traverse the WAN anyway, and using an Interaction Media Server in the Indianapolis Location requires that audio be sent to the Indianapolis Location even after the MRCP session completes.

Scenario 4

- The CIC server checks the first entry in Default Media Server Selection Rule assigned to the Orlando Location: <This Location>.
- If an Interaction Media Server is not available in the Orlando Location, the CIC server checks the second entry in Default Media Server Selection Rule: <ICServerLocation>.
- If an Interaction Media Server is available in the Indianapolis Location, the CIC server uses it for the call.
- Since the Interaction Media Server handling the call is in the Indianapolis Location, the CIC server checks the first entry in Default MRCP Selection Rule assigned to the Indianapolis Location: <This Location>.
- If an MRCP server is not available in the Indianapolis Location, the CIC server checks the second entry in Default MRCP Selection Rule: <ICServerLocation>.
- Since <This Location> and <ICServerLocation> are the same, the CIC server checks the third entry in Default MRCP Selection Rule: <Any>.
- At this point, the CIC server could, based on availability, select any of the MRCP servers in any Location.

Analysis:

This scenario is the least ideal as audio traverses two WAN connections. Usage of the <Any> entry in selection rules should be a rare occurrence as it depends on both Interaction Media Server, where the call arrived, and the MRCP server, at the CIC server Location, being unavailable.

Custom MRCP Selection Rules

If you decide to use custom selection rules, you can create and assign those rules to Locations instead of using the default selection rule.

Note:

For information on creating selection rules, see "Selection Rules" in *Interaction Administrator Help*.

Custom scenarios

Note:

These scenarios represent only some of the possibilities for MRCP Selection Rules and are intended to only highlight how Custom MRCP Selection Rules function.

This section provides scenarios for customer MRCP Selection Rules.

For these scenarios, there are three Locations defined in CIC:

- Indianapolis Location of the CIC server
- Miami Contact center location with a fast WAN connection with Orlando
- Orlando Contact center location with a fast WAN connection with Miami

In this environment, the Miami and Orlando locations should use selection rules that fall back to each other to take advantage of the shorter geographical distance and the fast WAN connection. Also, the WAN connection from Orlando to Indianapolis has more bandwidth than the connection from Miami to Indianapolis.

The following table lists the entities of the CIC network in each Location and the order of MRCP selection rule preferences for each Location:

Indianapolis	Miami	Orlando
Gateway	Gateway	Gateway
CIC server	Media server	Media server
Media server	MRCP server	MRCP server
MRCP server		
IRule	MRule	ORule
Indianapolis	Miami	Orlando
Orlando	Orlando	Miami
Miami	Indianapolis	Indianapolis

Each of the following scenarios starts when a call comes into the Orlando Location.

Scenario 1

- The CIC server checks the first entry in Default Media Server Selection Rule assigned to the Orlando Location: <This Location>.
- If an Interaction Media Server is available in the Orlando Location, the CIC server uses it for the call.
- The CIC server checks the first entry in Custom MRCP Selection Rule assigned to the Orlando Location: Orlando.
- If an MRCP server is available in the Orlando Location and is not on probation, the CIC servers uses it for media operations in the call.

Analysis:

The scenario represents the optimal functionality as the audio remains in the Orlando Location as is identical to Scenario 1 in the "[Default scenarios](#)" section.

Scenario 2

- The CIC server checks the first entry in Default Media Server Selection Rule assigned to the Orlando Location: <This Location>.
- If an Interaction Media Server is available in the Orlando Location, the CIC server uses it for the call.
- The CIC server checks the first entry in Custom MRCP Selection Rule assigned to the Orlando Location: Orlando.
- If an MRCP server is not available in the Orlando Location, the CIC server checks the second entry in Custom MRCP Selection Rule: Miami.
- If an MRCP server is available in the Miami Location and is not on probation, the CIC server uses it for media operations in the call.

Analysis:

This scenario demonstrates how a Custom MRCP Selection Rule enables you to specify preferences for Locations that different from those in Default MRCP Selection Rule, which would have first tried the Orlando Location and then the Indianapolis Location.

Scenario 3

- The CIC server checks the first entry in Default Media Server Selection Rule assigned to the Orlando Location: <This Location>.
- If an Interaction Media Server is not available in the Orlando Location, the CIC server checks the second entry in Default Media Server Selection Rule: <ICServerLocation>.
- If an Interaction Media Server is available in the Indianapolis Location, the CIC server uses it for the call.
- Since the Interaction Media Server handling the call is in the Indianapolis Location, the CIC server checks the first entry in Custom MRCP Selection Rule assigned to the Indianapolis Location: Indianapolis.
- If an MRCP server is available in the Indianapolis Location and is not on probation, the CIC server uses it for media operations in the call.

Analysis:

In this scenario, Custom MRCP Selection Rule has the same behavior as Default MRCP Selection Rule because the CIC server used Default Media Server Selection Rule.

If Custom Media Server Selection Rule was used, it could specify the Miami Location stead of the Indianapolis Location for the Interaction Media Server selection. However, since the selected Interaction Media Server is in the Indianapolis Location, it is better to avoid transmission of the audio over another WAN connection.

Scenario 4

- The CIC server checks the first entry in Default Media Server Selection Rule assigned to the Orlando Location: <This Location>.
- If an Interaction Media Server is not available in the Orlando Location, the CIC server checks the second entry in Default Media Server Selection Rule: <ICServerLocation>.
- If an Interaction Media Server is available in the Indianapolis Location, the CIC server uses it for the call.
- Since the Interaction Media Server handling the call is in the Indianapolis Location, the CIC server checks the first entry in Custom MRCP Selection Rule assigned to the Indianapolis Location: Indianapolis.
- If an MRCP server is not available in the Indianapolis Location, the CIC server checks the second entry in Custom MRCP Selection Rule: Orlando.
- If an MRCP server is available in the Orlando Location and is not on probation, the CIC server uses it for media operations in the call.

Analysis:

This scenario is the least ideal as audio traverses two WAN connections. Using Custom MRCP Selection Rule enables you to enforce a preference to use the WAN between the Indianapolis and Orland Locations instead of allowing the CIC server to select an MRCP server in the Miami Location.

Priority

The **Priority** setting in Interaction Administrator determines the priority of an MRCP server. The CIC server first considers MRCP servers with lower priority numbers.

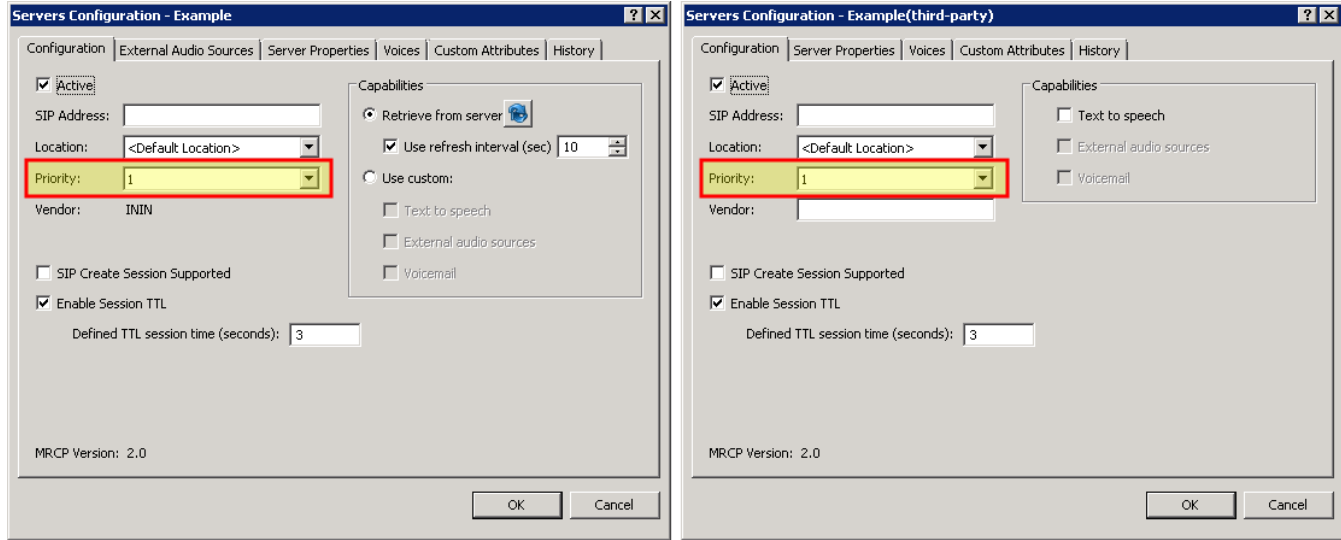

Note:

The **Priority** setting does not apply to Interaction Text to Speech. The **Priority** setting applies to only Interaction Media Streaming Server.

Load balancing

The MRCP subsystem of CIC supports a simple load-balancing scheme. The MRCP subsystem tracks the number of open sessions it has for each MRCP server and selects the one with the least amount of sessions to service the next MRCP request.

Note:

This strategy does not take into account the following items:

- The current CPU load of an MRCP server
- The architecture of an MRCP server
- The number of sessions in use by other CIC servers
- The session limit of any particular MRCP server

Add an MRCP server

Once you have installed an MRCP server, add it to you CIC Server configuration in Interaction Administrator. For more information, see [Installation and configuration](#).

1. On the CIC server, open Interaction Administrator.
2. In the left pane of the **Interaction Administrator** window, expand the **System Configuration** container.
3. Locate and expand the **MRCP Servers** container.
4. Select the **Servers** container.
5. In the right pane, right-click and select **New** from the resulting context menu.

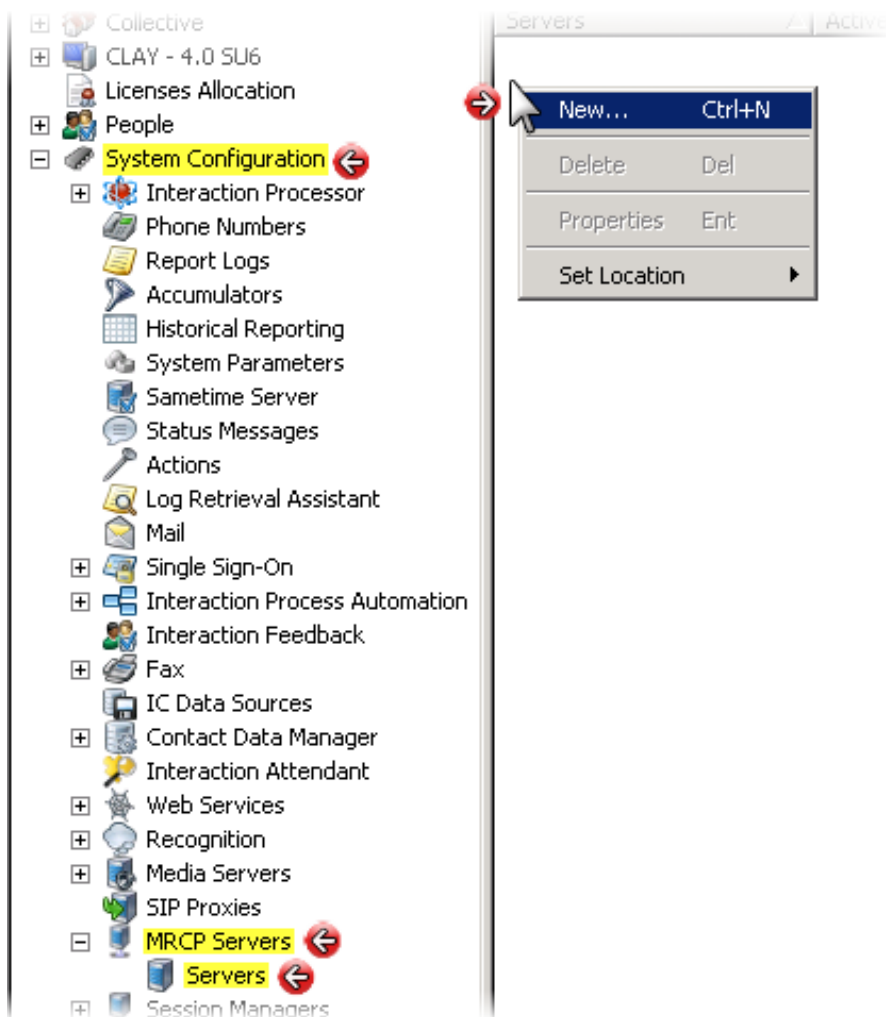

The New MRCP Server dialog box appears.

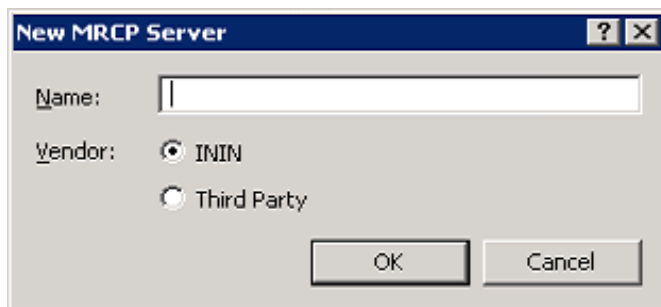

6. In the **Name** box, enter an identifier for this MRCP server.

Tip:

Since the key to identifying your MRCP server is its SIP address, you can assign any name to it.

7. In the **Vendor** group, select the provider of the MRCP server:

- **ININ** – Select this option if you are using Interaction Media Streaming Server.
 - **Third Party** – Select this option if you are using an MRCP server from another vendor, such as Nuance or Loquendo.
8. Select **OK**.

The **Servers Configuration** dialog box for the selected option appears:

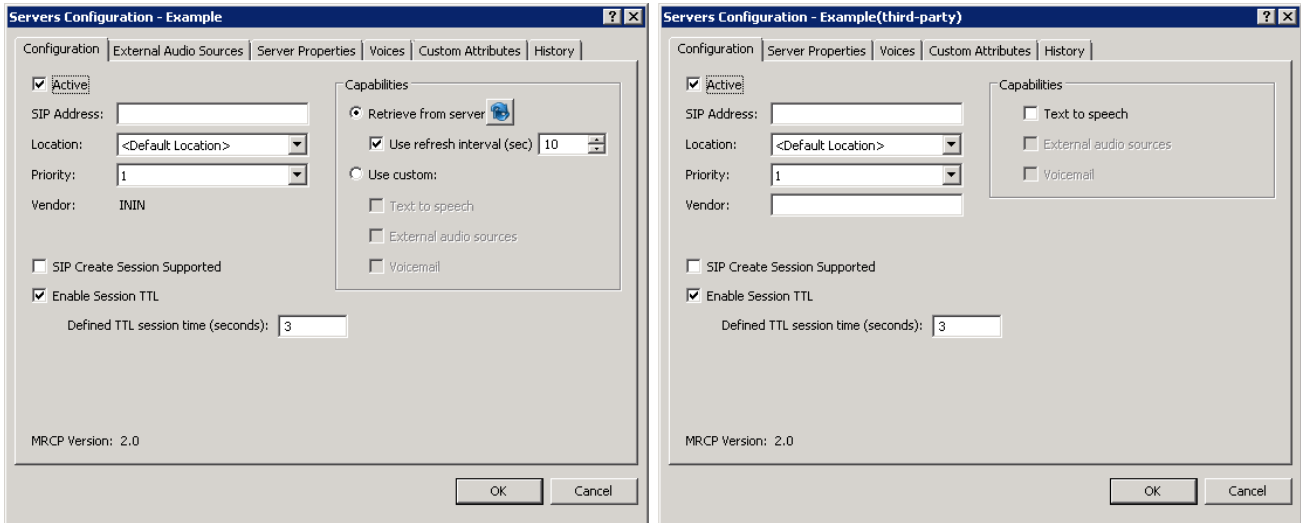

Note:

The **Servers Configuration** dialog box for **ININ** is slightly different from the **Third Party** instance.

9. In the **SIP Address** box, enter the SIP address of the MRCP server using the following format:
- ```
sip:user@domain:port
```
- user*, *domain*, and *port* are variables that represent the IP address or server name, network domain, and network port number for the MRCP server.

**Note:**

To avoid conflict with the default ports used by other SIP endpoints, Genesys recommends that you use port 6060 for SIP communications to MRCP servers. If you use a different port, ensure that the port setting in the MRCP server definition in Interaction Administrator and the network port used by the MRCP server are the same value.

10. Optionally, you can assign this MRCP server to an existing **Location** defined in your CIC environment. For more information, see [Assign an MRCP server to a Location](#).
11. Ensure the **Priority** box is set to 1.

For more information on the **MRCP Server Configuration** dialog box, see *Interaction Administrator Help*.



# Assign an MRCP server to a Location

If you have MRCP servers in multiple regions, you can ensure the best performance and most efficient use of available WAN bandwidth by assigning your MRCP servers to Locations.

## Note:

To do this procedure, you must have previously defined Locations through Interaction Administrator. For more information, see "IC Server" > "Regionalization" > "Create Location" in *Interaction Administrator Help*.

1. On the CIC server, open Interaction Administrator.
2. In the left pane of the **Interaction Administrator** window, expand the **System Configuration** container.
3. Locate and expand the **MRCP Servers** container.
4. Select the **Servers** container.  
The right pane displays your defined MRCP servers.
5. Double-click an MRCP server entry that you want to assign to a defined Location.  
The **Servers Configuration** dialog box for the selected MRCP server appears.
6. In the **Location** box, select a defined Location to which you want to assign this MRCP server.

The screenshot shows the Interaction Administrator interface. On the left, the System Configuration tree is expanded to MRCP Servers > Servers. A table lists MRCP servers, with 'Third Party MRCP Server' selected. The 'Servers Configuration - Third Party MRCP Server' dialog is open, showing the 'Location' dropdown menu with 'Indianapolis' selected. The dialog includes fields for SIP Address, Location, Priority, Vendor, and checkboxes for Active, SIP Create Session Supported, and Enable Session TTL. A 'Capabilities' section has checkboxes for Text to speech, External audio sources, and Voicemail. The MRCP Version is 2.0.

| Servers                 | Active | Location     | Priority | SIP Address     | Vendor |
|-------------------------|--------|--------------|----------|-----------------|--------|
| Third Party MRCP Server | Yes    | <Default ... | 1        | sip:mresourc... | Nuance |

**Servers Configuration - Third Party MRCP Server**

Configuration | Server Properties | Voices | Custom Attributes | History

Active

SIP Address: sip:mresources@SevenStar:6060

Location: <Default Location> (dropdown menu open showing Indianapolis, Miami, Orlando, Seattle)

Priority: <Default Location>

Vendor: (dropdown menu open showing Miami, Orlando, Seattle)

SIP Create Session Supported

Enable Session TTL

Defined TTL session time (seconds): 3

MRCP Version: 2.0

OK Cancel Apply

**Tip:**

You can quickly assign MRCP servers to a location by right-clicking the MRCP server entry in the right pane and selecting the Location from the resulting context menu.

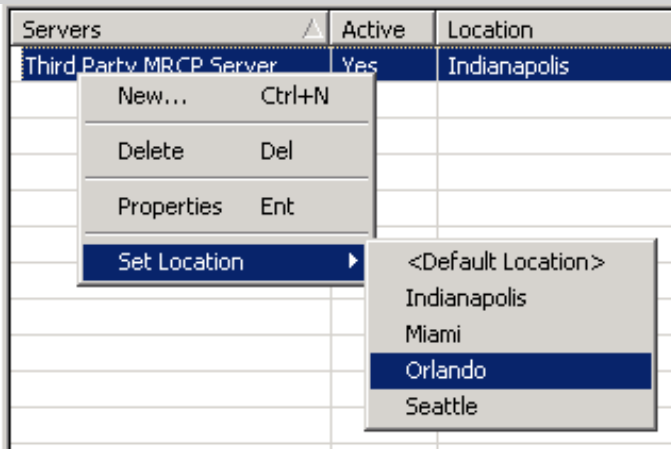

# Assign MRCP Selection Rules to a Location

If the default MRCP Selection Rule does not provide sufficient functionality for your CIC environment, you can create custom Selection Rules and assign them to Locations.

1. On the CIC server, open Interaction Administrator.
2. In the left pane of the **Interaction Administrator** window, locate and expand the object that represents your CIC server.
3. Expand the **Regionalization** container.
4. Select the **Locations** object to display your Location Names in the right pane.
5. In the right pane, double-click a Location Name.  
The **Locations Configuration** dialog box appears.
6. Select the **Selection Rules** tab.
7. Use the **MRCP Server** list box to assign a Selection Rule to this Location.

The screenshot shows the Interaction Administrator interface. On the left, the tree view is expanded to 'Regionalization' > 'Locations'. The 'Indianapolis' location is selected in the right pane. The 'Locations Configuration - Indianapolis' dialog box is open, showing the 'Selection Rules' tab. The 'MRCP Server' list box is expanded, showing a list of selection rules: <Default MRCP Selection Rule>, <Default ASR Selection Rule>, <Default Media Server Selection Rule>, <Default MRCP Selection Rule>, <Default Session Manager Selection Rule>, IRule, ORule, and SRule. The 'IRule' is currently selected in the list box. The dialog box also shows other server configuration options like Media Server, Session Manager, Content Server, and ASR Server, all set to their default selection rules. At the bottom, there are navigation arrows, a 'Confirm auto-save' checkbox, and 'OK', 'Cancel', and 'Apply' buttons.

| Location Name      | Description                 | Access Control Group |
|--------------------|-----------------------------|----------------------|
| <Default Location> | The system default location |                      |
| Indianapolis       |                             | Root                 |
| Miami              |                             | Root                 |
| Orlando            |                             | Root                 |
| Seattle            |                             | Root                 |

For more information on creating Selection Rules, see "Selection Rules" in *Interaction Administrator Help*.

**Note:**

If you want to return to using Default MRCP Selection Rule for MRCP servers in this Location, repeat this procedure and select <Default MRCP Selection Rule> in the MRCP Server list box.

## Alternative method for assigning an MRCP server to a Location

1. On the CIC server, open Interaction Administrator.
2. In the left pane of the **Interaction Administrator** window, locate and expand the object that represents your CIC server.
3. Expand the **Regionalization** container.
4. Select the **Locations** object to display your Location Names in the right pane.
5. In the right pane, double-click a Location Name.  
The **Locations Configuration** dialog box appears.
6. Select the **Endpoints** tab.
7. In the **Endpoint type** box, select **MRCP Servers**.
8. In the **Available endpoints** box, select the MRCP server you want to assign to this Location.
9. Click the arrow button to move the selected MRCP server to the **Selected endpoints** panel.

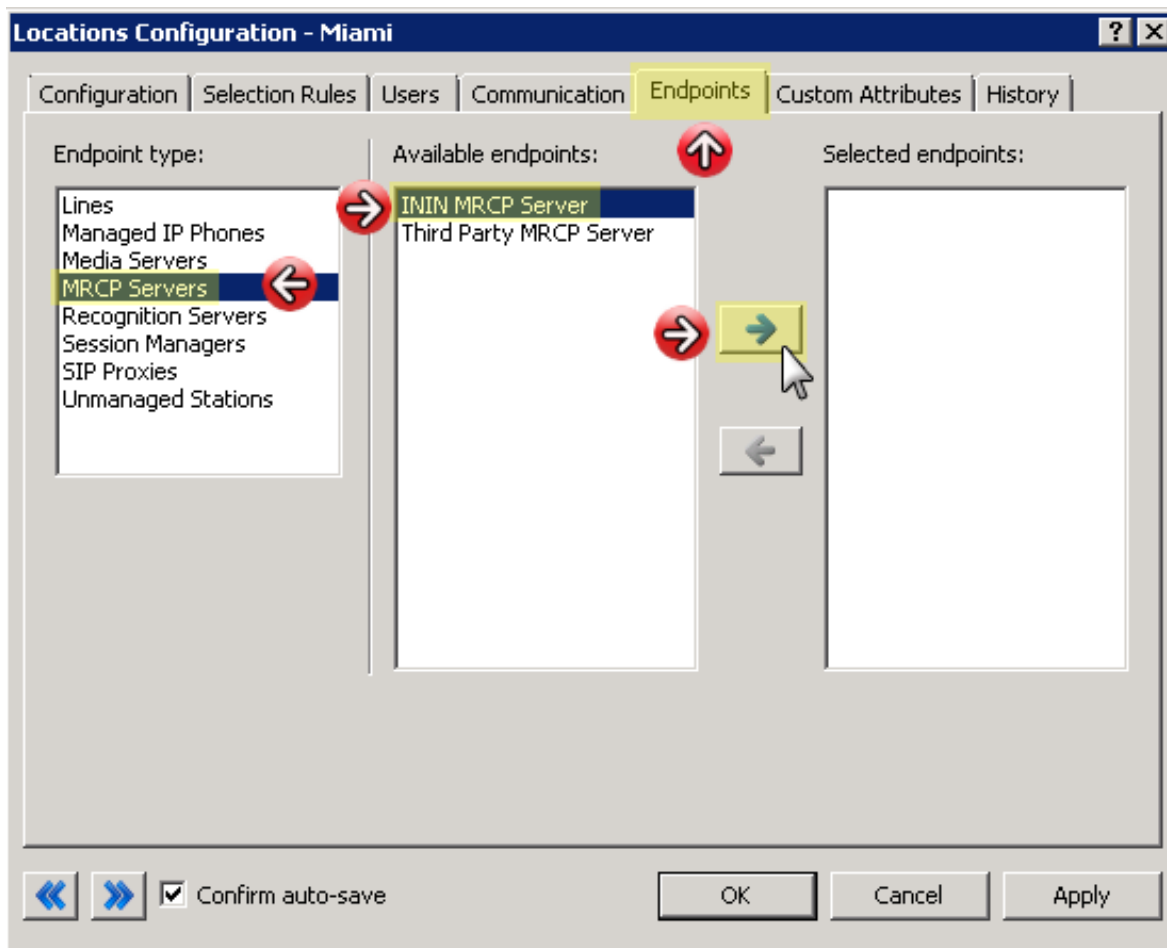

10. Select the OK button.

# Configure an MRCP server for Text to Speech

1. On the CIC server, open Interaction Administrator.
2. In the left pane of the **Interaction Administrator** window, expand the **System Configuration** container.
3. Locate and expand the **MRCP Servers** container.
4. Select the **Servers** container.
5. In the right pane, under the **Servers** column, double click your server.  
The **Servers Configuration** dialog box appears for the selected server.
6. Depending on the vendor of the selected MRCP server, do the appropriate action:
  - **Third-Party** – Enable the **Text to speech** check box.

The screenshot displays the Interaction Administrator interface. On the left, the 'System Configuration' tree is expanded to 'MRCP Servers' > 'Servers'. The main area shows a table of servers:

| Servers                 | Active | Location           | Priority | SIP Address              |
|-------------------------|--------|--------------------|----------|--------------------------|
| Third Party MRCP Server | Yes    | <Default Location> | 1        | sip:mresources@SevenStar |

The 'Servers Configuration - Third Party MRCP Server' dialog box is open, showing the following configuration:

- Active
- SIP Address: sip:mresources@SevenStar:6060
- Location: Indianapolis
- Priority: 1
- Vendor: Nuance
- SIP Create Session Supported
- Enable Session TTL
- Defined TTL session time (seconds): 3
- MRCP Version: 2.0
- Capabilities:
  - Text to speech
  - External audio sources
  - Voicemail

- **ININ** – The **Retrieve from server** option is selected by default. This option configures the MRCP server to make its services available to the CIC server. Select the adjacent button to immediately request services.

| Servers          | Active | Location           | Priority | SIP Address              |
|------------------|--------|--------------------|----------|--------------------------|
| ININ MRCP Server | Yes    | <Default Location> | 1        | sip:mresources@SevenStar |

**Servers Configuration - ININ MRCP Server**

Configuration | External Audio Sources | Server Properties | Voices | Custom Attributes | History

**Active**

SIP Address:

Location:

Priority:

Vendor: ININ

SIP Create Session Supported

**Enable Session TTL**

Defined TTL session time (seconds):

MRCP Version: 2.0

**Capabilities**

Retrieve from server

Use refresh interval (sec)

**Use custom:**

Text to speech

External audio sources

Voicemail

**Note:**

If you want the CIC server to continuously request services from this MRCP server, enable the **Use refresh interval (sec)** check box and set a value in the adjacent box to define the period of time to elapse between requests.

Select the **Use custom** option if you want to specify the capabilities of the MRCP server manually, even if those feature are not yet enabled or configured on the MRCP server.

**Capabilities**

Retrieve from server

Use refresh interval (sec)

**Use custom:**

Text to speech

External audio sources

Voicemail

Enable the **Text to speech** check box to allow the MRCP server to convert text to synthesized speech in calls.

Enable the **External audio sources** check box to allow the MRCP server to provide streaming audio that is injected into calls, such as Music on Hold.

Enable the **Voicemail** check box to allow the MRCP server to insert voice mail messages into calls.

7. Select the **Voices** tab.
8. On the **Voices** tab, select the **Add** button to display the **Enter Synthesizer Voice Name** dialog box.

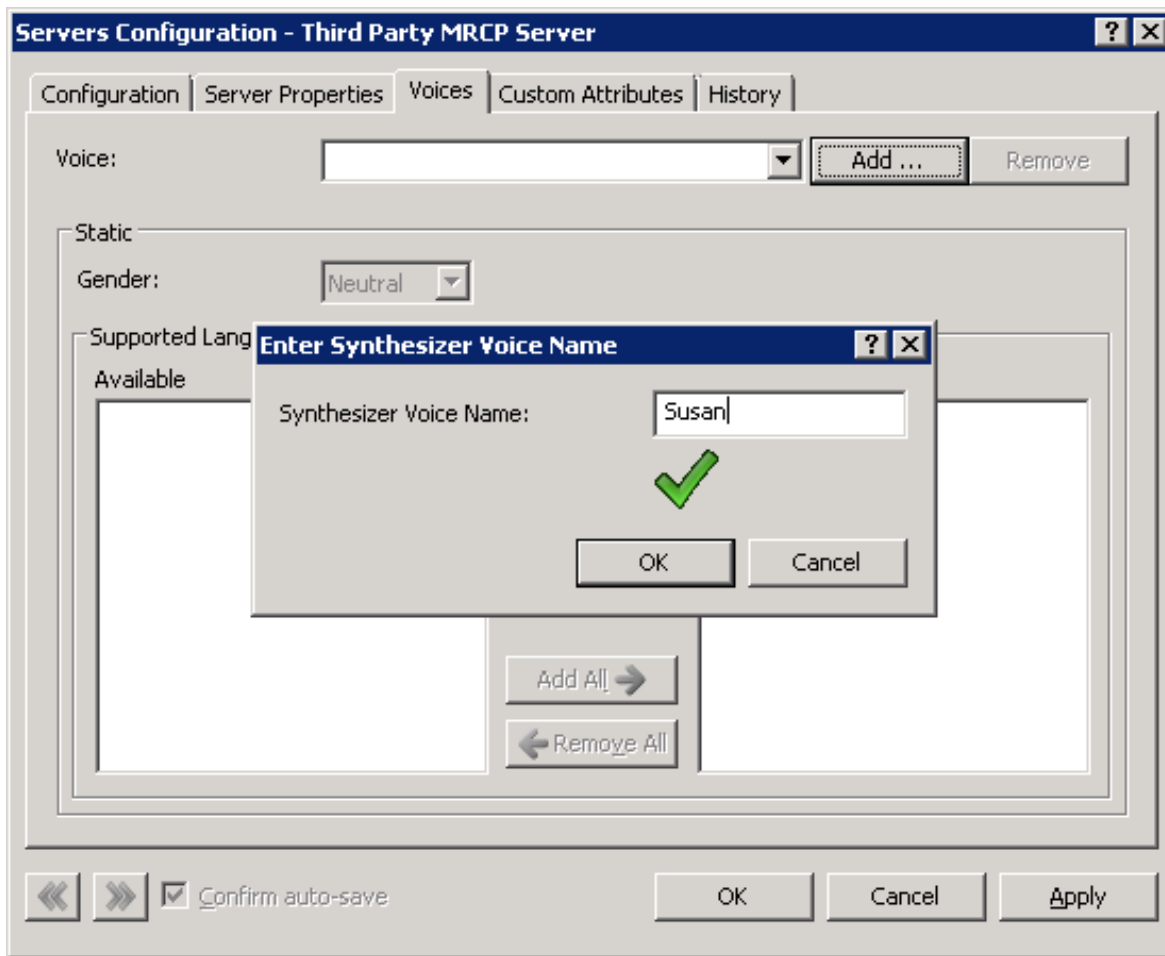

9. In the **Synthesizer Voice Name** box, enter the name of the TTS synthesizer.

**Important!**

TTS synthesizer names are specific to language models that are provided by your TTS vendor. Ensure that you enter the correct name of the appropriate TTS synthesizer.

10. Select the **OK** button.  
The **Enter Synthesizer Voice Name** dialog box closes.
11. Set the following controls on the **Voices** tab:
  - **Gender**
  - **Supported Languages**

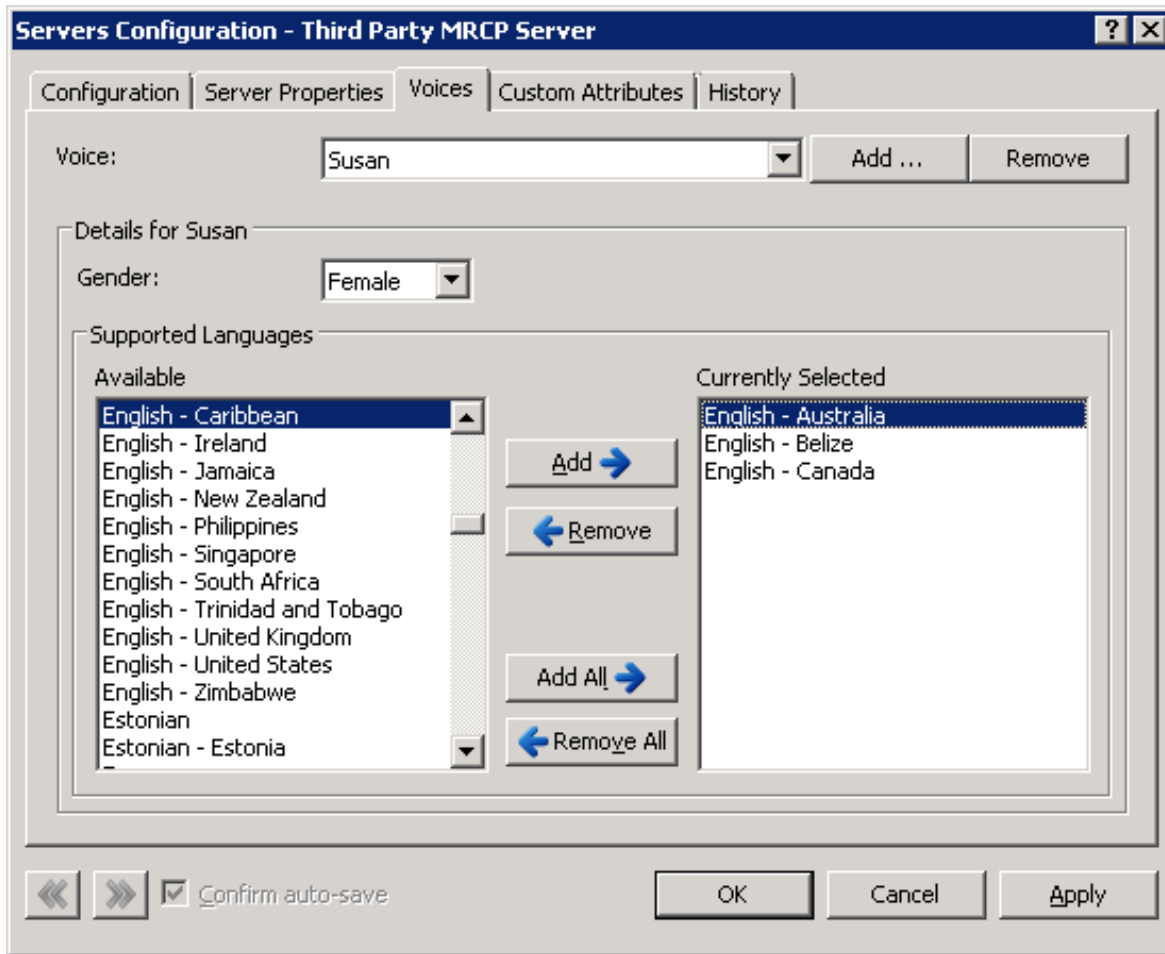

12. Select the OK button.

The **Servers Configuration** dialog box for the selected MRCP server closes.

**Note:**

For more information about the tabs and controls of the **Servers Configuration** dialog box, see *Interaction Administrator Help*.



# Test a TTS MRCP server installation

After you install and configure a third-party MRCP server, and configure the CIC server to use it, Genesys recommends that you test the MRCP configuration to ensure that everything works correctly.

1. Use a custom handler that has a **Play String Extended** tool step.
2. To configure the tool step to use MRCP in this play operation, access the **Play String Extended** properties dialog box and select the **Inputs** tab
3. In the **Optional Parameters** box, enter "MRCP" as the first parameter.

**Important!**

You must include the quotation marks.

4. Select the **OK** button to save your changes.
5. Test the handler and verify that the modified tool step works correctly.

The screenshot shows a dialog box titled "Properties of Play String Extended (2)" with a close button (X) in the top right corner. The dialog has two tabs: "General" and "Inputs", with "Inputs" selected. The "Inputs" tab contains the following fields and controls:

- Call Identifier:** A dropdown menu with "Interaction1" selected.
- Text:** A text box containing "Hello. This is Donna. A TTS voice from Nuance." with a right-pointing arrow button.
- Voice Name:** A text box containing "'Donna'" with a right-pointing arrow button.
- Volume:** A text box containing "?" with a right-pointing arrow button.
- Speed:** A text box containing "?" with a right-pointing arrow button.
- Immediate Mode:** An unchecked checkbox.
- Load Controller timeout (milliseconds):** A text box containing "300" with a right-pointing arrow button.
- Optional Parameters:** A text box containing "'MRCP'" with a right-pointing arrow button.

At the bottom of the dialog are four buttons: "OK", "Cancel", "Apply", and "Help". Below the dialog box, the word "String" is visible in a small box.

If the tool step works as desired, the MRCP configuration has been installed and configured correctly.

# Configure CIC to use MRCP server for all Text to Speech

You can configure CIC to automatically use MRCP for all Text-to-Speech (TTS) plays.

1. On the CIC server, open Interaction Administrator.
2. In the left pane of the Interaction Administrator window, select the **System Configuration** container.
3. In the right pane, double-click **Configuration**.  
The **System Configuration** dialog box appears.
4. Select the **Text To Speech** tab.
5. In the **Default TTS Provider** list box on the **Text To Speech** tab, select MRCP.

**System Configuration**

Site Information | ACD Options | Interaction Client | Update Service | Custom Attributes | History

Languages | Mailboxes | Host Server | Trace Logs

Connection Security | Certificate Management | Prompt Server | **Text To Speech** | Display Name Format

Default TTS Provider:  (dropdown menu showing SAPI, MRCP, SAPI)

SAPI Configuration

Concurrent Session Limit:       Number of Sessions Currently in Use:

Concurrent Session Warning Level:       Volume Control (0-100 default=100):

| Voice Name | Voice Path | Voice Language |
|------------|------------|----------------|
|------------|------------|----------------|

Add  
Edit  
Delete

OK      Cancel      Apply

**Note:**

If you want to use Interaction Text to Speech for all Text to Speech and have applied the appropriate Interaction Text to Speech licenses, the **Default TTS Provider** list box will also list **Media Server**. Select **Media Server** in the **Default TTS Provider** list box to use Interaction Text to Speech.

6. Select the **OK** button to save your changes.

## Change MRCP connection timeout

By default, the CIC server waits 5 seconds for configured MRCP servers to respond to an MRCP request. If an MRCP server does not respond within that period of time, the CIC server places that MRCP server on probation. If necessary, you can change this value.

1. On the CIC server, open Interaction Administrator.
2. In the left pane of the **Interaction Administrator** window, expand the **System Configuration** container and select the **MRCP Servers** container.
3. In the right pane, under the **MRCP Servers** column, double-click **Configuration**.  
The **MRCP Servers Configuration** dialog box appears.
4. In the **Connection Timeout** box, enter the number of seconds that you want the CIC server to wait for responses from MRCP servers.

For more information on the tabs and settings in the **MRCP Servers Configuration** dialog box, see [Interaction Administrator Help](#).

# Check Windows Event Viewer for probation warnings

When the CIC server puts an MRCP server on **Probation**, it also writes an entry to the Windows Event Log as a **Warning** notification with **Event ID 39613** in the **Application** log. These entries indicate that there was at least one failed attempt to use an MRCP server.

If the problem that caused the probation was temporary and the MRCP server was able to begin creating resources, the CIC server removes the probation status for the MRCP server and writes a different notification to the Windows Event Log on the CIC server. In this case, an **Information** level notification with **Event ID 39614** is written to the **Application** log.

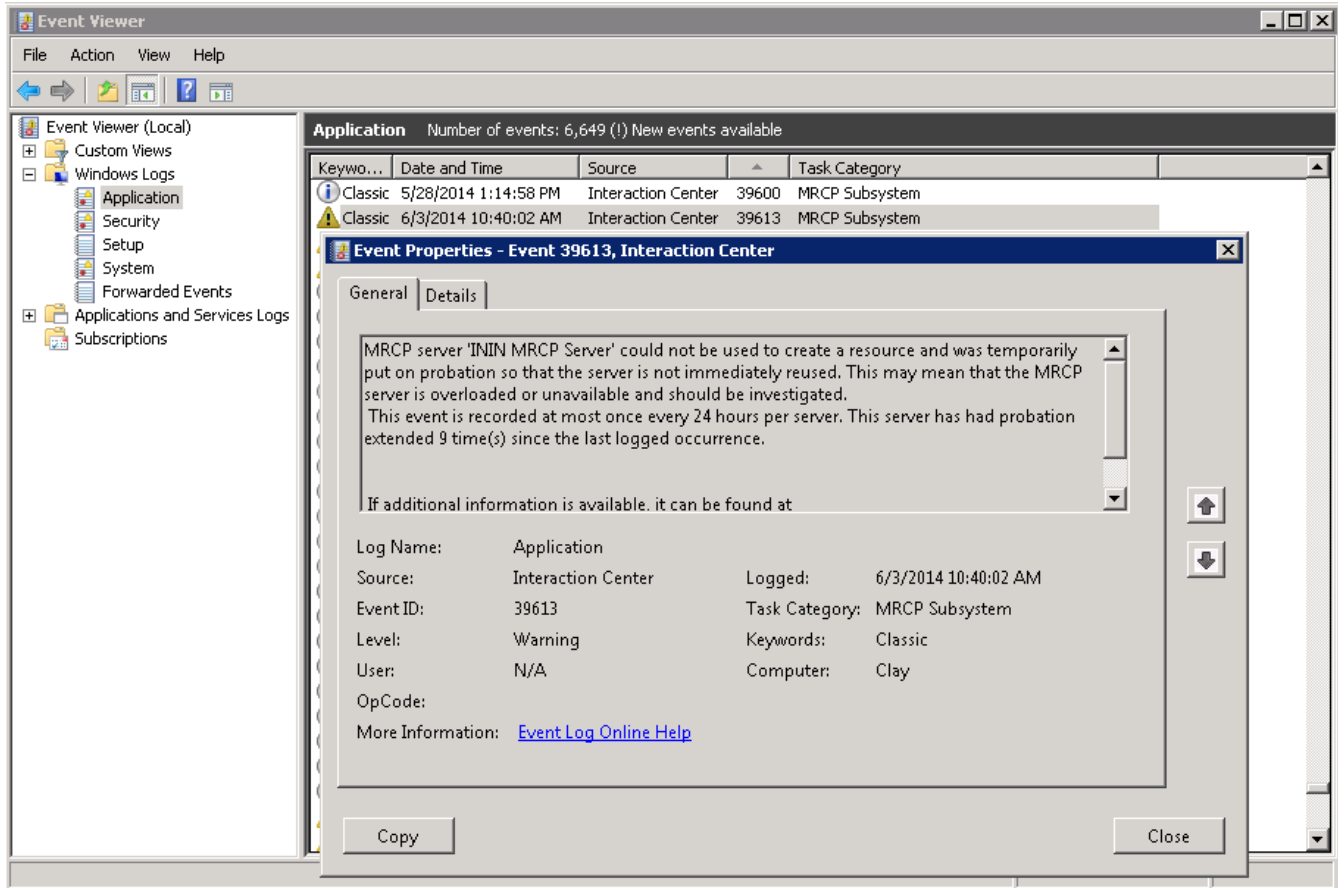

# Deactivate an MRCP server

If you need to deactivate an MRCP server due to continuous errors resulting in probation or for maintenance, you can remove it from the active operations by deactivating it through Interaction Administrator. You can then perform the necessary tasks on the MRCP server while ensuring that its deactivation does not impact calls.

1. On the CIC server, open Interaction Administrator.
2. In the left pane of the **Interaction Administrator** window, expand the **System Configuration** container.
3. Locate and expand the **MRCP Servers** container.
4. Select the **Servers** container.
5. In the right pane, under the **Servers** column, double click the MRCP server to deactivate.  
The **Servers Configuration** dialog box for the selected server appears.
6. On the **Configuration** tab, disable the **Active** check box.

The screenshot shows the Interaction Administrator interface. On the left is a tree view with 'System Configuration' expanded to 'MRCP Servers' > 'Servers'. The main area displays a table of servers:

| Servers                 | Active | Location           | Priority | SIP Address              |
|-------------------------|--------|--------------------|----------|--------------------------|
| Third Party MRCP Server | No     | <Default Location> | 1        | sip:mresources@SevenStar |

The 'Servers Configuration - Third Party MRCP Server' dialog box is open, showing the 'Configuration' tab. The 'Active' checkbox is unchecked. The 'SIP Address' is 'sip:mresources@SevenStar:6060', 'Location' is 'Indianapolis', 'Priority' is '1', and 'Vendor' is 'Nuance'. The 'Capabilities' section has 'Text to speech' checked, 'External audio sources' unchecked, and 'Voicemail' unchecked. The 'SIP Create Session Supported' checkbox is unchecked, and 'Enable Session TTL' is checked with a 'Defined TTL session time (seconds)' of '3'. The 'MRCP Version' is '2.0'. At the bottom, there are 'OK', 'Cancel', and 'Apply' buttons, and a 'Confirm auto-save' checkbox.

7. Select the **OK** button to close the **Servers Configuration** dialog box.

## Note:

If there are any active sessions on the MRCP server when you deactivate it, those sessions continue until complete. Before you shut down or perform maintenance on the MRCP server, Genesys recommends waiting a period of time after deactivation to ensure that you do not disrupt any remaining calls.

# Reactivate an MRCP server

## Note:

If an MRCP server was on probation when deactivated, the MRCP server is taken off probation and the probation period is reset. If the problem causing the failure to respond reoccurs, the CIC server will begin the probation process again, regardless of how many times the MRCP server had been previously placed on probation.

1. On the CIC server, open Interaction Administrator.
2. In the left pane of the **Interaction Administrator** window, expand the **System Configuration** container.
3. Locate and expand the **MRCP Servers** container.
4. Select the **Servers** container.
5. In the right pane, under the **Servers** column, double click the MRCP server to reactivate.  
The **Servers Configuration** dialog box for the selected server appears.
6. On the **Configuration** tab, enable the **Active** check box.

The screenshot displays the Interaction Administrator interface. On the left, a tree view shows the navigation structure, with 'System Configuration' expanded to 'MRCP Servers' and 'Servers' selected. The main pane shows a table of servers:

| Servers                 | Active | Location           | Priority | SIP Address              |
|-------------------------|--------|--------------------|----------|--------------------------|
| Third Party MRCP Server | No     | <Default Location> | 1        | sip:mresources@SevenStar |

The 'Servers Configuration - Third Party MRCP Server' dialog box is open, showing the 'Configuration' tab. The 'Active' checkbox is checked. The 'SIP Address' is 'sip:mresources@SevenStar:6060', 'Location' is 'Indianapolis', 'Priority' is '1', and 'Vendor' is 'Nuance'. The 'Capabilities' section includes 'Text to speech' (checked), 'External audio sources' (unchecked), and 'Voicemail' (unchecked). The 'SIP Create Session Supported' checkbox is unchecked, and 'Enable Session TTL' is checked with a 'Defined TTL session time (seconds)' of 3. The 'MRCP Version' is 2.0. At the bottom, there are navigation arrows, a 'Confirm auto-save' checkbox (checked), and 'OK', 'Cancel', and 'Apply' buttons.

7. Select the **OK** button to close the **Servers Configuration** dialog box.

# Interaction Designer for TTS

When a CIC system uses MRCP as its default Text-to-Speech (TTS) provider, the Interaction Designer Tools, in the telephony palette, automatically use the MRCP server for speech synthesis. The Play operations in the following handler would all use the MRCP server.

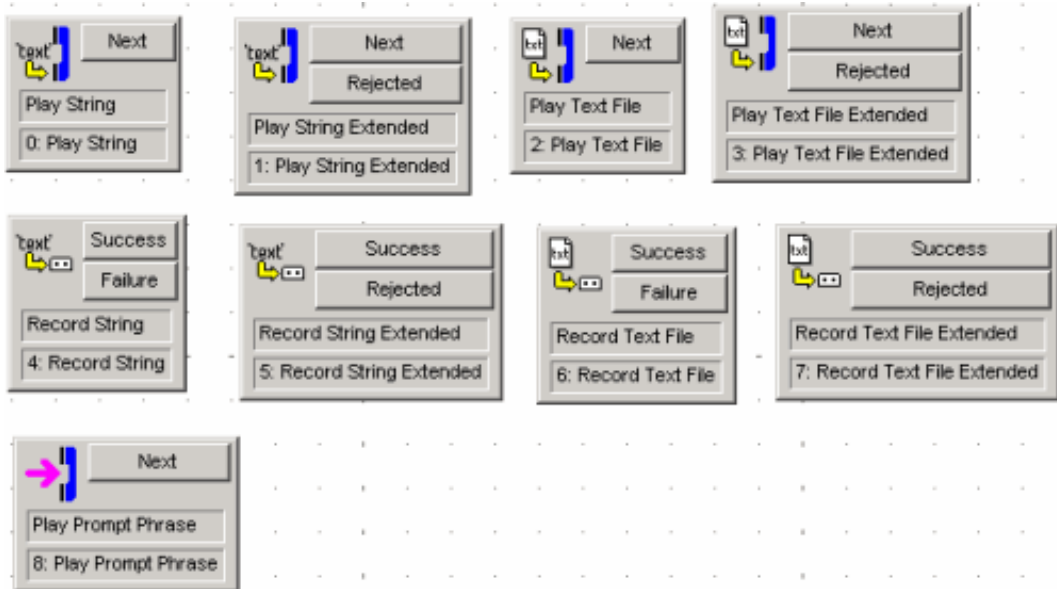

# MRCP with SAPI

You can configure your CIC server to use Microsoft Speech API (SAPI) for voice synthesis in conjunction with an MRCP server. This configuration requires you to not use MRCP for Text-to-Speech (TTS) by default. You must then configure TTS operations through handler development using parameters.

1. On the CIC server, open Interaction Administrator.
2. In the left pane of the **Interaction Administrator** window, expand the **System Configuration** container.
3. In the right pane of the **Interaction Administrator** window, double-click **Configuration**.  
The **System Configuration** dialog box appears.
4. In the **System Configuration** dialog box, select the **Text To Speech** tab.
5. In the **Default TTS Provider** list box, select **SAPI**.
6. Select the **OK** button.  
The **System Configuration** dialog box closes.
7. To use MRCP when SAPI is the default TTS provider, use the **Extended** version of the prompt tools:



8. Open the **Properties** dialog box of a **Play** tool step.



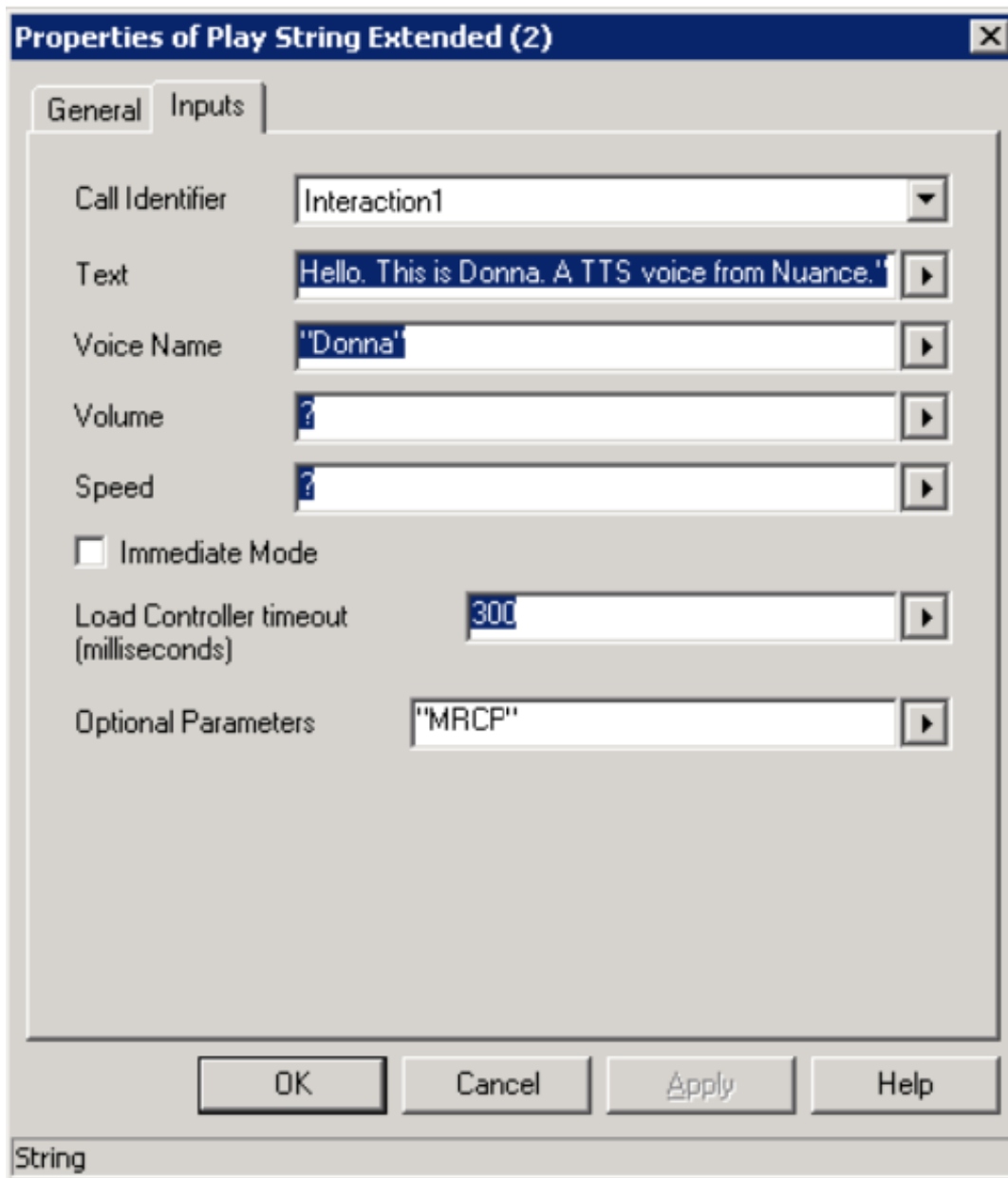

- In the **Optional Parameters** box, enter "MRCP" as the first parameter.

**Important!**  
You must include the quotation marks.

- Select the **OK** button to save your changes.
- Test the handler and verify that the modified tool step works correctly.

## MRCP optional parameters

Use additional MRCP parameters to control speech synthesis in a tool step. Multiple entries in the **Optional Parameters** box must be space-delimited as displayed in the following example:

```
"MRCP mrcp.audio.voice.name:Sally"
```

If a parameter requires a value, separate the name/value pair with a colon (:) as displayed in the following example:

```
"mrcp.audio.contentType:application/ssml+xml"
```

The following table describes valid MRCP parameters.

| Parameter                                                           | Description                                                                                                                                           | Values                                                                                                                                                                                                                                                                                                                                                                                                                                                 |
|---------------------------------------------------------------------|-------------------------------------------------------------------------------------------------------------------------------------------------------|--------------------------------------------------------------------------------------------------------------------------------------------------------------------------------------------------------------------------------------------------------------------------------------------------------------------------------------------------------------------------------------------------------------------------------------------------------|
| MRCP                                                                | Controls whether MRCP should be used for TTS<br><br><b>Note:</b><br>This parameter must be the first parameter in the <b>Optional Parameters</b> box. |                                                                                                                                                                                                                                                                                                                                                                                                                                                        |
| mrcp.audio.voice.gender                                             | The gender of the voice when configuring MRCP TS servers in Interaction Administrator.                                                                | Enter one of the following values: <ul style="list-style-type: none"> <li>• Neutral</li> <li>• Male</li> <li>• Female</li> </ul>                                                                                                                                                                                                                                                                                                                       |
| mrcp.audio.server.name                                              | Uses the specified MRCP server to synthesize the text to speech                                                                                       | MRCP server name as specified in Interaction Administrator                                                                                                                                                                                                                                                                                                                                                                                             |
| mrcp.audio.voice.name                                               | Uses the specified MRCP voice to synthesize the text to speech                                                                                        | MRCP voice name as specified in Interaction Administrator                                                                                                                                                                                                                                                                                                                                                                                              |
| *mrcp.audio.voice.rate                                              | SSML prosody rate of a voice                                                                                                                          | Enter one of the following types of values: <ul style="list-style-type: none"> <li>• <b>Float multiplier:</b> A value of 2.0 equals twice the rate. A value of 0.5 equals half of the rate</li> <li>• <b>Predefined values:</b> <ul style="list-style-type: none"> <li>◦ x-slow</li> <li>◦ slow</li> <li>◦ medium</li> <li>◦ fast</li> <li>◦ x-fast</li> <li>◦ default</li> </ul> </li> </ul>                                                          |
| *mrcp.audio.voice.volume                                            | SSML prosody volume                                                                                                                                   | Enter one of the following types of values: <ul style="list-style-type: none"> <li>• <b>An absolute number in the range of 0 to 100</b> with 0 representing silence and higher values increasing the volume.</li> <li>• <b>One of the following predefined values:</b> <ul style="list-style-type: none"> <li>◦ silent</li> <li>◦ x-soft</li> <li>◦ soft</li> <li>◦ medium</li> <li>◦ loud</li> <li>◦ x-loud</li> <li>◦ default</li> </ul> </li> </ul> |
| *mrcp.audio.language                                                | Uses a voice that supports the specified language                                                                                                     | Identifiers as specified in <a href="#">RFC3066</a> : language-country                                                                                                                                                                                                                                                                                                                                                                                 |
| mrcp.audio.vendor                                                   | The MRCP server vendor to use                                                                                                                         | MRCP vendor as specified in Interaction Administrator                                                                                                                                                                                                                                                                                                                                                                                                  |
| *mrcp.audio.contentType                                             | The content type of the text being synthesized                                                                                                        | <ul style="list-style-type: none"> <li>• text/plain (default)</li> <li>• application/ssml+xml</li> <li>• text/uri-list</li> <li>• multipart/mixed</li> </ul>                                                                                                                                                                                                                                                                                           |
| *These parameters are vendor dependent and vary between TTS engines |                                                                                                                                                       |                                                                                                                                                                                                                                                                                                                                                                                                                                                        |

# Frequently asked questions

"Are MRCP servers required for some functionality or are they always optional?"

MRCP servers are not required. An alternative solution for Text-to-Speech (TTS) is to use Microsoft Speech API (SAPI), which is the default TTS provider of a CIC system. You can configure SAPI voices by accessing the Speech applet in Windows Control Panel. By default, SAPI TTS processing is done on the CIC server, but some vendors, such as Nuance RealSpeak, have SAPI implementations that support off-server installations. With some vendors, such as Loquendo, MRCP is the only solution available to be able to offload TTS processing.

"How many MRCP servers do we need for each site?"

The number of servers for each site is dependent on the TTS usage of each one, including TTS IVR prompts, email playback, custom rules, and so forth.

"How do you configure MRCP ASR servers in Interaction Administrator?"

Only the MRCP synthesizer (TTS) resources are configured in Interaction Administrator. MRCP ASR servers are configured using the ASR Server MRCP controller. See *ASR Technical Reference* for more details on configuring MRCP server settings for ASR.

# Change log

The following table lists the changes to the *MRCP Technical Reference* since its initial release.

| Date             | Changes                                                                                                                                                                                                                                                                                                           |
|------------------|-------------------------------------------------------------------------------------------------------------------------------------------------------------------------------------------------------------------------------------------------------------------------------------------------------------------|
| 23-July-2012     | Updated Copyright and Trademarks for 2012                                                                                                                                                                                                                                                                         |
| 26-July-2012     | Updated document for selecting an MRCP server based on location                                                                                                                                                                                                                                                   |
| 9-January-2013   | Updated document for 4.0 SU3 release for ASR MRCP support.                                                                                                                                                                                                                                                        |
| 15-January-2013  | Updated document for configuring MRCP servers to use Media Streaming Server for voice mail playback.                                                                                                                                                                                                              |
| 25-February-2013 | Updated Copyright and Trademarks for 2013.                                                                                                                                                                                                                                                                        |
| 10-June-2014     | <ul style="list-style-type: none"><li>• Updated Copyright and Trademarks for 2014.</li><li>• Reorganized document contents.</li><li>• Added information on Location and Selection Rules.</li><li>• Added information about Probation.</li></ul>                                                                   |
| 5-August-2014    | Updated documentation to reflect changes required in the transition from version 4.0 SU# to CIC 2015 R1, such as updates to product version numbers, system requirements, installation procedures, references to Interactive Intelligence Product Information site URLs, and copyright and trademark information. |
| 1-July-2015      | <ul style="list-style-type: none"><li>• Updated cover page to reflect new color scheme and logo.</li><li>• Updated copyright and trademark information.</li></ul>                                                                                                                                                 |
| 9-October-2015   | <ul style="list-style-type: none"><li>• Updated references to Interaction Desktop</li><li>• Updated the document to reflect the CIC 2016 R1 version.</li></ul>                                                                                                                                                    |
| 4-February-2016  | <ul style="list-style-type: none"><li>• Updated Copyright and Trademarks for 2016.</li><li>• Added link to the new CIC Documentation Library at <a href="http://help.inin.com">help.inin.com</a></li></ul>                                                                                                        |
| 30-June-2016     | <ul style="list-style-type: none"><li>• IC-136830 - Added content for Interaction Text to Speech</li><li>• Made general edits throughout the document</li></ul>                                                                                                                                                   |
| 10-May-2018      | Rebranded from Interactive Intelligence to Genesys.                                                                                                                                                                                                                                                               |
| 17-July-2018     | Added <code>mrpc.audio.voice.gender</code> to MRCP optional parameters.                                                                                                                                                                                                                                           |
| 14-June-2019     | Reorganized the content only, which included combining some topics and deleting others that just had an introductory sentence such as, "In this section...".                                                                                                                                                      |