



PureConnect®

2023 R1

Generated:

08-February-2023

Content last updated:

27th-January-2022

See [Change Log](#) for summary of changes.



Interaction Recorder and Interaction Quality Manager

Technical Reference

Abstract

This technical reference discusses installing, configuring, and using Interaction Recorder, the software solution for multichannel recording, quality assessment control, compliance safeguards, and storage management. The Interaction Recorder and Interaction Quality Manager features include the ability to record and assess calls, emails, and web chats. This document also includes information for screen recording, configuring Interaction Recorder policies, and using the Interaction Recorder Client for searching and playing back recordings. And this document provides information on using Interaction Quality Manager to retrieve recordings with associated Questionnaire Scorecards that need to be scored.

For the latest version of this document, see the PureConnect Documentation Library at: <http://help.genesys.com/pureconnect>.

For copyright and trademark information, see https://help.genesys.com/pureconnect/desktop/copyright_and_trademark_information.htm.

Table of Contents

Table of Contents	2
About this information	5
Interaction Recorder	6
Interaction Quality Manager	7
Additional information	8
Overview	9
Interaction Recorder Server Subsystem	9
Interaction Recorder Configuration Container	9
Interaction Recorder Policy Editor	10
Interaction Screen Recorder	10
Interaction Media Server	10
Remote Content Service Server	10
Interaction Recorder	10
Built-In Workspaces	11
New View	11
Interaction Recorder Extreme Query	12
How Interaction Recorder Works	13
Policy-based Recordings	14
Snippet Recordings	14
Proactive Recording	14
Playing Back Interactions	14
Archive Recordings	15
Screen Recording	15
Screen Recording Server-side Process	15
Screen Recordings without an Interaction	15
Secure Screen Recording Pause	15
Client-side Process	15
Regional Locations	15
Recorder Database	16
Interaction Recorder Server and Remote Content Service Server Health Check	16
IC Business Manager Content Servers View	16
Interaction Recorder SNMP Statistics	16
Interaction Recorder PMQ Statistics	16
Installing and Configuring Interaction Recorder	17
Planning for Installation	17
Software and Hardware Requirements	17
Licensing	17
Hardware Sizing	18
Planning for Interaction Screen Recorder	20
Licensing for Screen Recorder	20
Software requirements	21
Interaction Screen Recorder Capture Client requirements	21
Installing Interaction Recorder	21
Interaction Recorder Installation Procedures	21
Configuring Interaction Recorder in Interaction Administrator	23
Interaction Recorder Configuration	23
Configuring Interaction Screen Recorder	28
Installing Interaction Recorder Client	31
Planning for Installation	31
Licenses	31
Install Interaction Recorder Client	31
Starting IC Business Manager	35
Installing Interaction Screen Recorder	36
Interaction Recorder Server	36
Interaction Screen Recorder Capture Client	36
Planning Interaction Screen Recorder Capture Client Installation	36
Licenses	37
Install Interaction Screen Recorder Capture Client	38
IC User Applications (64-bit) Setup Wizard installation	38
IC User Applications (64-bit) command-line installation	43
Silent Login for Capture Client	43

Using Policy Editor	44
About Interaction Recorder Policy Editor	44
About the Policy Editor User Interface	44
Start Policy Editor	45
Creating an Initiation Policy	46
Create a New Initiation Policy	47
Initiation Policy Criteria Descriptions	53
Creating a Retention Policy	61
Default Storage Location Policy	61
Create a New Retention Policy	62
Creating a Security Policy	72
Administrators Security Policy	72
Create a New Security Policy	73
Security Policy Criteria Descriptions	79
Policy Editor Toolbar	82
Change Policy	83
Copy	85
Delete	85
Order	85
Re-evaluate	85
Options	86
Interaction Recorder Snippet Recording	87
About Snippet Recordings	87
Requirements for Snippet Recordings	87
Licensing for Snippet Recordings	87
Configuration for Snippet Recordings	87
Create a Snippet Recording	90
Creating a Snippet Recording in Interaction Desktop and Interaction Connect	91
Creating a Snippet Recording in Interaction Supervisor	91
Creating an email Snippet Recording	91
Viewing Snippet Recordings	92
Snippet Recordings in Search Results	92
Playback a Snippet Recording	94
Related Recordings	95
Using Interaction Recorder Client	96
About Interaction Recorder	97
Interaction Quality Manager View	98
About the Interaction Recorder Client User Interface	99
Create a Search	99
Recording Search	100
Add Attributes to a Recording Search	104
Scorecard Search	119
Add Attributes to a Scorecard Search	123
Run and View a Search	128
Run a Recording Search	128
Save a Recording Search	130
Edit a Recording Search	130
View Recording Search Results	130
Work with Recording Search Results	132
Recordings	149
Open Recordings	168
Score a Recording	169
Recording Search Results Shortcut Menu	177
Run a Scorecard Search	193
Save a Scorecard Search	195
Edit a Scorecard Search	195
View Scorecard Search Results	196
Work with Scorecard Search Results	196
Edit a Search	207
Questionnaires	207
About the Interaction Quality Manager Navigation Pane	207
Creating a Questionnaire	209
Publishing a Questionnaire	211
Tools Menu	212
Manage Interaction Recorder Settings	213

Manage Questionnaire Rankings	213
Interaction Quality Manager View	215
Recordings to Score	215
Recordings to Score View	218
Interaction Recorder and Interaction Quality Manager Reports	225
Appendix A: Recording Encryption	226
Recording Keys and Master Keys	226
Recording Keys	226
Master Keys	226
Encryption Key security	226
Generating a Custom Master Key	226
Setting up the Master Key File	228
Key Generation Configuration	228
Master Key Password	229
Recurring key generation	230
Enabling Recording Encryption	230
Appendix B: Search Configuration Migration Notes Control	233
Appendix C: Interaction Recorder Server Parameters	235
Appendix D: Archive Recordings	237
Automatically Archiving Recordings	238
Manually Archiving Recordings	238
Working with Archived Content	240
Retrieving Archived Recordings	240
Appendix E: Archive Log Resource Templates	244
Modifying Resource Templates	244
Template Guidelines	244
Volume Content Index log file	244
Volume Content Log File	247
Appendix F: Identify Recordings by Spotted Keywords and Phrases for Evaluation	252
Appendix G: Setup Automatic Login with SSO in Screen Recorder	253
Appendix H: Snippet Recordings of Email Interactions	254
Enable Email Snippet Recordings	254
Creating an Email Snippet Recording	254
Considerations for Email Snippet Recordings	254
Appendix I: Interaction Screen Recorder Capture Client config.xml file	255
Appendix J: Interaction Recorder Event IDs	256
Appendix K: SIP Proxy Recording Recovery	257
Information Required (Prerequisites)	258
Public Recorder Key	258
Retention Location	258
Processed Files Location:	258
Playback from ICBM Client	259
Using the Tool	260
Utility commands:	260
Examples:	260
Utility Output	260
Change Log	261

About this information

The installation and configuration information in this guide is for CIC System administrators, Genesys Business partners, and anyone who is interested in learning how to install and configure Interaction Recorder.

Interaction Recorder

Interaction Recorder® is a Customer Interaction Center® (CIC) all-software solution for multichannel recording, quality assessment control, compliance safeguards, and storage management. Interaction Recorder includes the following features for recording and file management.

- Multichannel media recording for phone calls, IVR, web text chats, emails, and social media interactions.
- Policy-based recordings and user-initiated Snippet recordings
- Synchronized playback of screen and audio recordings
- Simple user interface to easily configure rules-based recording policies
- Ability to store and playback recordings locally
- Intuitive categorization and retrieval features for recording file management
- Tags to quickly retrieve recording files
- Security and PCI compliance through the use of encryption

Interaction Recorder is included in CIC's core platform technology and its recording capabilities are enabled through simple licensing. Interaction Recorder is easily configured in Interaction Administrator.

The Interaction Recorder Policy Editor is a simple user interface for creating policies for recorded interactions, which include policies for where recordings are stored and archived, how long recordings are retained, and who can access, play, score, export, and archive recordings.

Adding Interaction Recorder's screen recording feature provides the ability to record and evaluate text-based interactions. Screen recording also provides more complete assessment of calls by providing the ability to observe agent navigation and use of systems during call handling.

Interaction Quality Manager

Interaction Quality Manager provides quality monitoring features that provide users with the ability to search and playback all recorded interactions, manage the quality monitoring process, and perform quality monitoring activities. With Interaction Quality Manager you can create evaluation forms and score recordings. Interaction Quality Manager's scoring features simplify quality and compliance assessment processes, while out-of-the-box reports facilitate measuring team and individual scoring results. Interaction Quality Manager provides integrated scoring and analytics for agent coaching and quality measurement.

This document includes:

- An Overview of Interaction Recorder
- How Interaction Recorder works
- Planning for your Interaction Recorder installation
- Installing and Configuring Interaction Recorder
- Installing Interaction Recorder Client for IC Business Manager
- Installing Interaction Screen Recorder Capture Client
- Using Interaction Recorder Client for IC Business Manager
- Using Interaction Recorder Policy Editor
- Using Interaction Quality Manager

Additional information

Because Interaction Recorder is integrated with CIC, there are additional technical references and guides that might be of interest to you. Documents are available in the PureConnect Documentation Library on your CIC server.

The latest version of these documents can also be accessed from the PureConnect Documentation Library on the Genesys Web site at: <http://help.genesys.com>.

The following technical references and Help systems can provide additional information for Interaction Recorder.

- *PureConnect Installation and Configuration Guide*
- *PureConnect Licensing Technical Reference*
- *Interaction Recorder Remote Content Service Installation and Configuration Guide*
- *Interaction Media Server Technical Reference*
- Interaction Recorder Policy Editor Help
- *Interaction Recorder Extreme Query Installation and Configuration Guide*
- Interaction Recorder Extreme Query Help
- Interaction Recorder Client for IC Business Manager Help
- *IC Business Manager User Interface Help Getting Started*
- Interaction Administrator Help
- PureConnect Reporter Help
- *PureConnect Data Dictionary*
- *Interaction Quality Management Data Dictionary Technical Reference*
- *Introduction to IceLib Technical Reference*
- *Interaction Analyzer Technical Reference*
- *CIC Migration Guide*
- Interaction Desktop Client Help
- Interaction Quality Manager Help
- *Social Media Technical Reference*

Overview

Interaction Recorder is integrated with CIC and provides: multichannel recording, screen recording, storage, and file management. Interaction Recorder provides the ability to search and playback media recordings and to manage quality assessment control. Interaction Recorder also provides security and PCI compliance, including encryption.

This overview section introduces the components of the Interaction Recorder solution. The components are documented in detail later in this documentation.

Interaction Recorder Server Subsystem

The Interaction Recorder Server subsystem components are installed as part of the CIC server installation process. These components, including configuration modules in Interaction Administrator, are accessible when the CIC server license includes Interaction Recorder Server and Interaction Recorder client workstation licenses. The Interaction Recorder Server subsystem basically controls all aspects of Interaction Recorder functionality, including recording chats, emails, and Social Media interactions. The Interaction Media Server records call interactions, including snippet recordings, and it compresses and encrypts call recordings. Interaction Recorder Server subsystem tasks include: reading Interaction Recorder Policies and determining which policies apply to interactions and recordings; performing sorting, searching, and filtering requests sent from the Interaction Recorder client; decrypting and streaming recordings to the Interaction Recorder client; and processing Interaction Recorder client requests to store and retrieve questionnaires.

Interaction Recorder Configuration Container

The Interaction Recorder configuration container is available in the Interaction Administrator navigation tree.

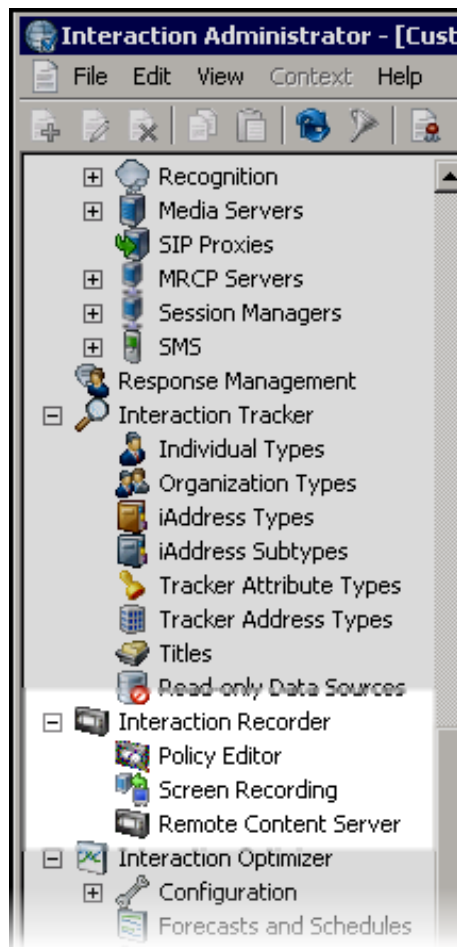

Use the Interaction Recorder Configuration dialog to configure the settings for Recording Processing, Email, Recording Generation, and Key Generation. Other components configured under Interaction Recorder are: Policy Editor, Screen Recording, and Remote Content Server.

Interaction Recorder Policy Editor

Policy Editor is a single, simple, user interface for creating Interaction Recorder policies that manage recordings. Policy settings for recordings include: *What* are the interactions to be recorded; *Where* recordings are stored and archived, and how long they are retained; and *Who* can access, play, score, export, and archive recordings. Policy Editor is used to create Initiation, Retention, and Security policies. To learn more about creating policies, see [Using Policy Editor](#). When creating and configuring a policy in Interaction Recorder Policy Editor, press F1 for specific Help on Policy Steps.

Interaction Screen Recorder

Interaction Screen Recorder, an Interaction Recorder feature, adds the screen recording capability to Customer Interaction Center (CIC). Interaction Screen Recorder requires a separate license and is installed as part of the CIC server installation process. Interaction Screen Recorder also includes the Interaction Screen Recorder Capture Client workstation service, which records the agent's screen. Screen recordings are synchronized with agent audio recordings during playback.

Interaction Media Server

Interaction Media Server records call interactions for CIC. Interaction Media Server compresses the recording, and then it encrypts the recording based on Policy Editor Security Policies. For more information about the Interaction Media Server, see the *Interaction Media Server Technical Reference* in the PureConnect Documentation Library.

Remote Content Service Server

The Interaction Recorder Remote Content Service server is highly recommended, especially in a distributed environment. In this environment, the Remote Content Service server copies recording files to the directory set by the Retention Policies. This service reduces the amount of data that is transmitted between locations over a WAN. Basically, the Remote Content Service offloads the network bandwidth needed to process, play, and export recordings. The Remote Content Service decrypts and streams recordings to the Interaction Recorder Client for playback. If Handset is selected for audio playback, the Remote Content Service server decrypts the recording and Media Server decompresses the recording and plays it to the handset. The Remote Content Service sends the recording information to Interaction Recorder on the CIC server, where the CIC Database will be updated. For more information about the Remote Content Service server, see the *Interaction Recorder Remote Content Service Installation and Configuration Guide* in the PureConnect Documentation Library.

Interaction Recorder

The following are the Interaction Recorder Built-In Workspaces and New View.

Built-In Workspaces

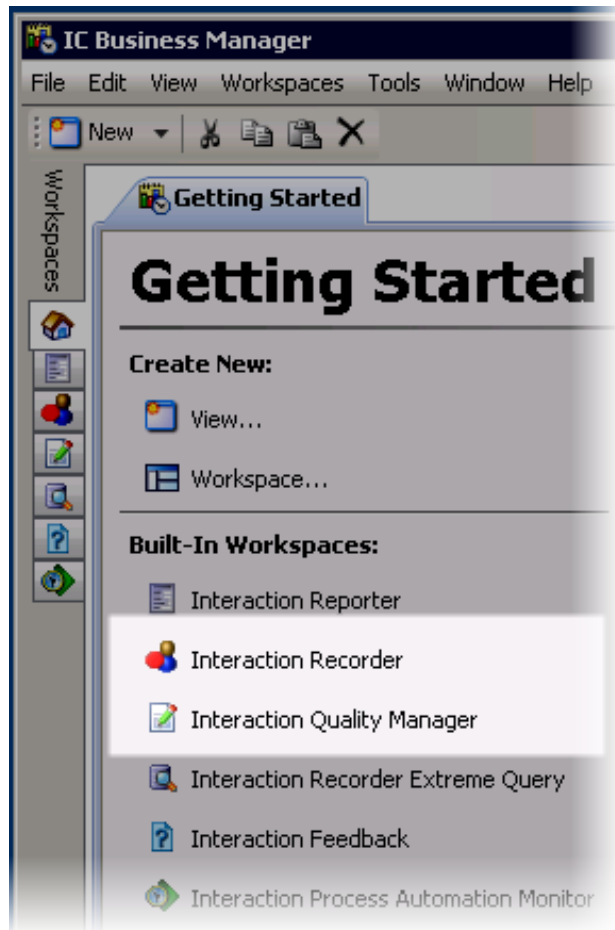

Interaction Recorder Workspace, an add-on module for IC Business Manager, is used to search and playback media recordings such as phone calls, web chats, emails, social media interactions, and screen recordings. And you can monitor live call recordings that are in progress. Interaction Recorder can also be used to score recordings and search and view scorecards.

Interaction Quality Manager Workspace is used to create questionnaires.

New View

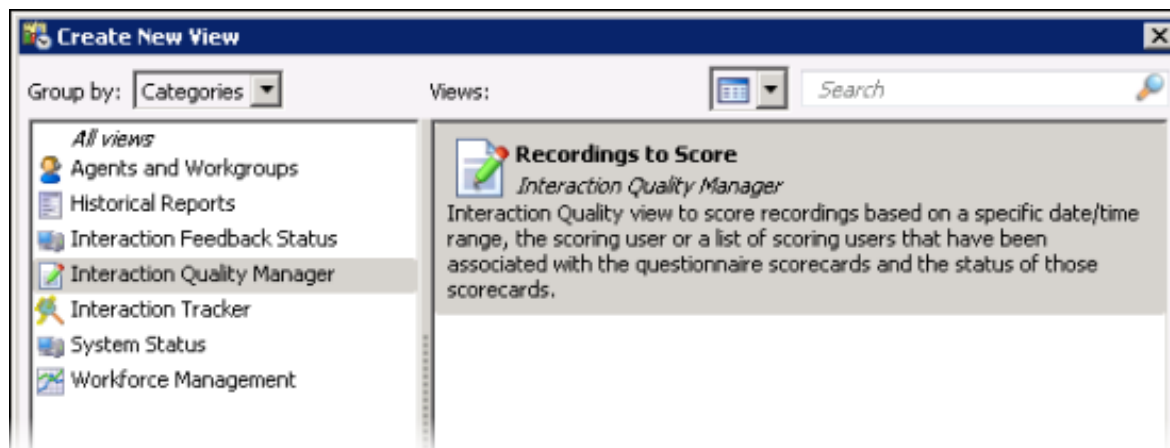

Interaction Quality Manager Recordings to Score New View is used to retrieve recordings with associated Questionnaire Scorecards that need to be scored. The view also displays the scorecard status.

For more information, see [Using Interaction Recorder Client](#).

Interaction Recorder Extreme Query

Interaction Recorder Extreme Query works with Interaction Recorder to make the search for call recordings quicker. Interaction Recorder Extreme Query is an optional solution, with its powerful query engine and interface working with a cache of information developed exclusively for recording file searches. There are two components for Extreme Query: the Interaction Recorder Extreme Query Server, and the Interaction Recorder Extreme Query Client. The Extreme Query Server is software that is installed on a standard Microsoft Windows 64-bit server. The Interaction Recorder Extreme Query Client, an add-on module for IC Business Manager, is an ultra-fast solution for running searches and retrieving stored call recordings for playback and scoring. With Extreme Query you can search for recorded calls, view and sort Search Results, view Graph Data of search results, playback and score recorded calls, and Export search results to a file. The Interaction Recorder Extreme Query Engine caches a subset of the recording data stored in the Interaction Recorder database in memory. The Extreme Query Engine pulls this information directly from the Interaction Recorder database and checks for new recordings every ten minutes. The Extreme Query Engine also performs the queries against the cached recording data.

If your organization requires managing large volumes of recordings, you might be interested in Extreme Query handling the high-capacity recording load you manage. For more information, see the *Interaction Recorder Extreme Query Installation and Configuration Guide* in the PureConnect Documentation Library.

How Interaction Recorder Works

Interaction Recorder is integrated with the Customer Interaction Center. Interaction Recorder records interactions, manages and stores the recording files, and provides search and playback of media recordings.

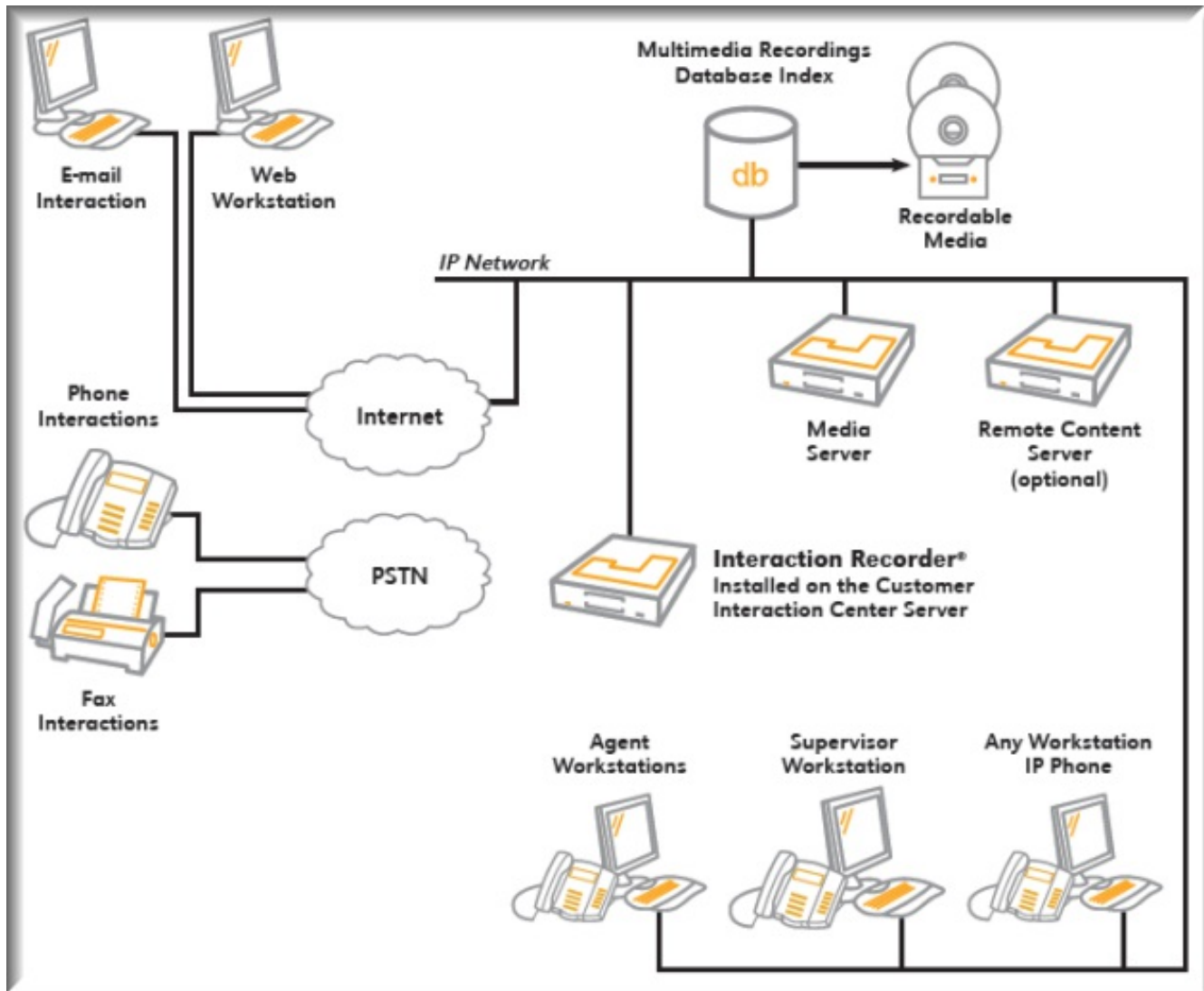

Policy-based Recordings

Interaction Recorder starts the recording process based on an Initiation Policy, instructing the Media Server to record the interaction if it is a call. When Media Server is instructed to record a call, it compresses the recording file, and if the Initiation Policy has the action to encrypt the recording, Media Server encrypts the file.

At the time the recording is started, Interaction Recorder writes the call information to the CIC Database, allowing the call to be available for immediate searching. Call information includes media details, such as: Recording Date and Time, Recording ID, Expiration Date, Initiation Policy, Interaction ID Key, Direction, Archived indicator, Encrypted indicator, Recording Length, (Recording Type, Call Line, and Call Type).

When Media Server completes the call recording processing, the recording file is copied to the directory specified in the Retention Policy for the call. If the recording is another type of interaction such as a chat or an email message, when it is complete, Interaction Recorder copies the file to the directory specified in the Retention Policy for the interaction. Interaction Recorder updates the CIC Database with current recording information, including the recording length and the file location.

Note

If the Media Server is not able to copy the recording to the directory specified in the Retention Policy, the recording data is kept for these calls in the CIC Database.

A high volume of call recordings being transmitted over a network might significantly impact the performance of the network. Adding a Remote Content Service server helps to reduce network traffic. It offloads the network bandwidth needed to process, play, and export recordings. The Remote Content Service decrypts and streams recordings to the Interaction Recorder Client for playback. For more information about the Remote Content Service server, see the *Interaction Recorder Remote Content Service Installation and Configuration Guide* in the PureConnect Documentation Library.

Snippet Recordings

Snippet recordings are recordings of calls and chat interactions, created by users and agents in Interaction Desktop and Interaction Connect, and by supervisors in Interaction Supervisor. Using the Snip button, users, with the appropriate security rights, manually initiate and stop Snippet recordings.

Proactive Recording

Proactive Recording can be used to start the recording process as soon as audio begins on a call and continue that recording until the call disconnects. Proactive Recording is configured in Interaction Administrator, and can include Hold Music and Early Audio (IVR and ACD Wait). Because Proactive Recording records every call on the line, it uses more resources on the Media Server, and it might not be appropriate for all deployments.

Playing Back Interactions

Recorded interactions are played back using Interaction Recorder Client for IC Business Manager. The Interaction Recorder Server subsystem services the requests of Interaction Recorder clients to search and playback recordings. Use Interaction Recorder client to build a Recording Search to retrieve recordings. Interaction Recorder executes the search and returns the results to the Interaction Recorder client. The results, including the recording details, are displayed in the Interaction Recorder client workspace. When a user requests to playback a recording, the Interaction Recorder client sends the request to the Interaction Recorder Server subsystem. If a Security Policy allows the user access to the recording, Interaction Recorder Server, or Remote Content Service server, decrypts and streams the recordings to the Interaction Recorder client. The Interaction Recorder client decompresses the recording and plays back the recording. If Handset is selected for audio playback, the Interaction Recorder Server subsystem, or the Remote Content Service server, decrypts the recording and Media Server decompresses the recording and plays it to the handset.

Archive Recordings

You can archive recordings to manage your organizations recorded interactions such as calls, chats, emails, social media interactions, and screen recordings. When you archive, the original recordings are copied in a playable format to an archive volume folder. The archive volume folder contains the archived recordings, information about the recordings, and an index in HTML format. Your existing recording information is maintained in the database and is flagged as being archived.

There are two ways to archive recordings: you can automatically archive recordings by creating an Interaction Recorder Policy Editor Retention Policy, and you can manually archive recordings from Interaction Recorder client in the search results grid.

For more information on archiving recordings, see [Appendix D: Archive Recordings](#) and [Appendix E: Archive Log Resource Templates](#).

Screen Recording

The two processes that comprise Interaction Screen Recorder are: Interaction Recorder Server process and the Interaction Screen Recorder Capture Client workstation service.

Screen Recording Server-side Process

Interaction Recorder Server initiates a screen recording by sending a message to the appropriate Interaction Screen Recorder Capture Client. When the screen recording is finished, Interaction Recorder Server sends a message to the Capture Client to send the recording to the storage location specified in the Retention Policy. This location could either be on a Remote Content Service server or the Interaction Recorder Server.

Screen Recordings without an Interaction

Screen recordings can also be initiated without an active interaction, using an IceLib API. The API allows you to start a recording with a timeframe for how long to record. This prevents *run away* screen recordings. Refer to the *Introduction to IceLib Technical Reference* for more information.

Secure Screen Recording Pause

Screen recordings can be paused to allow the entering of confidential information such as credit card information or social security numbers. The Agent can manually initiate a recording pause through the Interaction Desktop interface. In addition, there is a public API to pause and resume screen recording, providing the ability to control the screen recording with a 3rd-party desktop application. The screen recording pause of audio and screen recordings is synchronized both manually in Interaction Desktop, or programmatically using an API pause method. Refer to the *IceLib Technical Reference* for more information.

Client-side Process

The Interaction Screen Recorder Capture Client is installed on the agent workstation and records the agent's screen. Screen recordings can be associated with phone call and web chat interactions. Screen Recorder captures the full-screen desktop on the Interaction Screen Recorder Capture Client machine. The Capture Client service is installed on all Interaction Screen Recorder Capture Client machines and is responsible for recording the screen, compressing the recording, and encrypting the screen recording-if the Initiation Policy is configured to encrypt the screen recording. The Capture Client also sends the screen recording to the storage location, either on a Remote Content Service server or the Interaction Recorder Server.

Regional Locations

A Regional location is a group of Capture Clients that are connected using a high-speed link such as a LAN. When Regional locations are configured, Capture Client sessions are routed within a common location, whenever possible, allowing for a level of regionalization. Regional Locations are defined in Interaction Administrator.

Recorder Database

The CIC Database Configuration program configures the Interaction Recorder database tables along with other CIC tables as part of the overall CIC database installation and configuration. Recording metadata is written to the database when Interaction Recorder starts the recording process. Interaction Recorder extracts call attributes, for example: recording length, date and time, recording type, interaction ID Key, media type, recording ID, queue, and tags and attributes set by Initiation Policies and Snippet Recordings. Interaction Recorder writes this information as recording details in the Interaction Recorder database. For more information on Interaction Recorder database tables, see the *PureConnect Data Dictionary* in the PureConnect Documentation Library.

Interaction Recorder Server and Remote Content Service Server Health Check

The following information helps you to identify problems with recording transfers and to understand why recording transfers are failing.

IC Business Manager Content Servers View

Use IC Business Manager **Content Servers** view to display statistics for configured Interaction Recorder servers and Remote Content Service servers. The Content Server view allows system administrators to see the status of each server in real time and take action if any server is experiencing problems or exhausting its resources.

The Content Servers view lists each Interaction Recorder server and RCS server, and it includes statistical information for:

- Failed transfers last hour
- Total CPU usage
- Memory usage
- Recordings successfully processed last hour
- Recordings played back last hour
- Available local disk space
- Available HTTP client connections
- Available log disk space
- Configured for Amazon S3
- Available shared disk space

For more information, see the Help topic **Content Servers** view, in the Interaction Supervisor Help.

Interaction Recorder SNMP Statistics

In addition to Interaction Recorder statistics, multiple traps are exposed through SNMP on the CIC Server. With the SNMP feature, you can see when minor problems with the moving or playback of recordings occur.

The SNMP trap scenarios include:

- Any recording transfer failures
- When there is No Remote Content Server able to access a shared location configured in an Interaction Recorder Policy Editor retention policy
- Any RCS server in a region that has less than 5 GB of storage space

For more information on Interaction Recorder SNMP statistics and traps, see **Interaction Recorder** under "Customer Interaction Center Management Information Base files" in the *CIC and SNMP Technical Reference*.

Interaction Recorder PMQ Statistics

Interaction Recorder subsystem PMQ statistics are available in the IC Business Manager **System Statistics** view. Use these statistics to monitor the health of your Interaction Recorder subsystem.

For more details, from IC Business Manager, in Interaction Supervisor, see **System Statistics > PMQ** view.

Installing and Configuring Interaction Recorder

This section includes information on planning for your Interaction Recorder installation, and it also includes the steps for installing and configuring your Interaction Recorder subsystem.

Planning for Installation

Planning for your Interaction Recorder installation includes determining software and hardware requirements, acquiring appropriate licenses, and evaluating disk space requirements. Make sure you have fulfilled the prerequisites described in the *CIC Installation and Configuration Guide* for *other servers* on the network, such as Media Server.

Software and Hardware Requirements

Interaction Recorder is installed with the Customer Interaction Center (CIC) components on the CIC server. Interaction Recorder has the same minimum software and hardware requirements as the CIC servers. Software and hardware requirements for CIC servers are described in the *CIC Installation and Configuration Guide*. This document is located in the PureConnect Documentation Library, and the latest version can also be accessed from the PureConnect Documentation Library at <http://help.genesys.com>

Note CIC supports virtualization of the CIC environment. For the latest information, see the *CIC Virtualization Technical Reference* in the PureConnect Documentation Library.

Hardware requirements

Hardware requirements and sizing are available in the PureConnect Documentation Library at https://help.genesys.com/cic/mergedProjects/wh_tr/mergedProjects/wh_tr_installation_and_configuration/desktop/hardware_requirements.htm.

Licensing

Interaction Recorder is licensed separately from CIC, requiring: an Interaction Recorder Server Add-on license, an Interaction Recorder Access license for each user or station to be recorded, and an Interaction Recorder Client for IC Business Manager Access License to view and playback recordings. A separate feature license is required for Screen Recorder.

Be sure you have purchased all required Interaction Recorder licenses prior to your CIC server installation.

The following table describes the Interaction Recorder licenses.

License Feature	License Name	Description
Recorder Server	I3_FEATURE_RECORDER_BASE	Recorder Server Add-on When the Recorder Server license is included in the CIC server license, the Interaction Recorder components are accessible in Interaction Administrator.
InteractionRecorder Access	I3_ACCESS_RECORDER	Access Recorder This license allows a user or station to be recorded.
Interaction Recorder Client Access	I3_ACCESS_RECORDER_CLIENT	Access Recorder Client This license allows user access to the Interaction Recorder Client for IC Business Manager. It allows a user to create and execute Searches in Interaction Recorder Client for IC Business Manager.
Interaction Recorder Master Key Password	I3_FEATURE_RECORDER_MASTER_KEY_PASSWORD	Recorder Service Add-on When the Master Key Password license is included in the CIC server license, the Master Key Password function is available on the Interaction Recorder Key Generation page. To create or change a Master Key password, the administrator must have Master Key Password Administrator security rights assigned.
Interaction Quality Manager	I3_ACCESS_RECORDER_QUALITYMONITORING	Access Recorder Quality Monitoring This license allows Questionnaires and Scoring functionality for a user in the Interaction Recorder Client for IC Business Manager.

Interaction Recorder Extreme Query	I3_ACCESS_RECORDER_EXTREMEQUERY_CLIENT	<p>Interaction Recorder Extreme Query Client</p> <p>This license allows user access to the Interaction Recorder Extreme Query Client. It allows the user access to Searching, Playback, and Graph Data.</p> <p>Extreme Query also requires an I3_ACCESS_RECORDER_CLIENT user license.</p>
Screen Recorder Session	I3_LICENSE_SCREEN_RECORDER_SESSION	<p>Interaction Screen Recorder Session</p> <p>This is a port-based license required to record agent desktop screen activity. Interaction Screen Recorder also requires Interaction Recorder Server product and must be added to an Interaction Recorder Add-on license.</p> <p>This is the Interaction Recorder Screen Recorder license for Server and Capture Clients.</p> <p>A Screen Recorder Port License is needed for each agent's interaction or activity that needs to be recorded simultaneously, this is regardless of the number of physical monitors or display screens the user has on a Capture Client machine. In other words, if you need to record 20 interactions or agents at the same time, 20 port licenses are required.</p> <p>Note: The number of Screen Recording licenses currently in use can be viewed in IC Business Manager. To view the number of I3_LICENSE_SCREEN_RECORDER_SESSION licenses in use, from an IC Business Manager Default Workspace, under Create New, click View. In the right pane, click License Statistics.</p>
Screen Recorder Server	I3_FEATURE_RECORDER_ADVANCED	<p>Interaction Screen Recorder Server Product</p> <p>A single global license for the server that is required for screen recording.</p>
Interaction Recorder IVR Recording	I3_FEATURE_RECORDER_SYSTEM_RECORDING	<p>IVR Recording</p> <p>When using the Pro-active recording feature, this license permits recording and playback of IVR calls.</p> <p>This license does not apply to calls that connect to an agent. If a call connects to an agent, the agent's Recorder Access license is used to determine if the entire recording (including IVR) is licensed. If the agent has the Recorder Access license, the Agent's Recorded Access license permits recording of the entire call, including the IVR segment (if Pro-active recording is used.) Similarly, if the agent does not have the Recorder Access license, the IVR Recording license does not permit even the IVR segment of the call to be recorded.</p>

Interaction Recorder licenses are incorporated into the License Management system on the CIC server. Licenses can be viewed in the Licenses Allocation container in Interaction Administrator. You can also view the licenses on your system in Interaction Administrator by clicking the File menu, and then click License Management. And you can view license allocations in IC Business Manager License Statistics view.

Note

The number of Screen Recording licenses currently in use can only be viewed in IC Business Manager. To view the number of I3_LICENSE_SCREEN_RECORDER_SESSION licenses in use, from an IC Business Manager Default Workspace, under Create New, click View. In the right pane, click License Statistics.

Be sure to purchase your Interaction Recorder licenses ahead of the time you plan to install and test a new installation. For more information on licenses, see the *PureConnect Licensing Technical Reference* in the PureConnect Documentation Library.

Hardware Sizing

The most current hardware requirements are available in the PureConnect Documentation Library at https://help.genesys.com/cic/mergedProjects/wh_tr/mergedProjects/wh_tr_installation_and_configuration/desktop/hardware_requirements.htm.

The following section discusses the specific Interaction Recorder hardware sizing requirements and recommendations beyond the CIC server disk space requirements.

Hardware Sizing Overview

To properly size hardware for an Interaction Recorder installation, it is important to have a good estimate of the recorded call volume. The average number of recorded calls per day in seconds is required to properly size an Interaction Recorder installation.

The recorded call volume-in seconds-dictates *exactly* how much disk space is required to store compressed recordings. The recorded call volume, compression level, and the storage policy dictates *exactly* how much disk space is needed to store compressed recordings. The compression level determines *approximately* how much CPU capacity is required to keep up with the recording compression load on the Media Server. The recorded call volume determines how much network bandwidth is required to support Interaction Recorder. These three factors, disk space, CPU capacity, and network bandwidth, comprise the hardware requirements necessary for Interaction Recorder.

Generally, the sizing information is based in per-day units. This is because most customers exhibit a daily call cycle for recording: calls that need to be recorded are more frequent during certain periods of the day than at others. The *instantaneous* recorded call volume for any period of a day will tend to average out to a constant value. Weekends usually have a lower recorded call volume than weekdays, so weekday recording load estimates are used.

To size the hardware correctly for Interaction Recorder, make sure that Interaction Recorder and the Media Server have all the hardware needed to fulfill at least one day's worth of recording and compression in one day's time. The Media Server compresses audio recordings as they are made. If it is overloaded, the Media Server rejects additional recording requests, and recordings will not be made. Additional Media Servers might be needed to handle your recording requirements. If there is insufficient network bandwidth to handle the load of moving recordings, Interaction Recorder, or the Remote Content Service server, can get behind moving recordings from the Media Server to the storage location. Interaction Recorder will not work to your satisfaction if it cannot keep up with a day's worth of recordings.

Note

The example in this section is for a large recording operation. The more Media Servers in the mix, the more network traffic that will be generated. Your recorded call volume might be considerably smaller. If so, you can get by with moderate amounts of disk space and CPU capacity.

The example was chosen to underscore the considerations necessary for large recorded call volume sites. Such deployments require careful planning to estimate both hardware and network requirements.

Disk Space Requirements

The disk space required for Interaction Recorder is dependent on:

- Call recording volume—recorded seconds per day
- The compression algorithm used
- How often compressed recordings are moved and stored at another location, or purged

It is recommended that an Interaction Recorder installation have, at a minimum, enough disk space to store N days' worth of compressed recordings, where N is the number of days that an average recording will stay in the Interaction Recorder system without being moved to another location, or purged.

To determine the total disk space required for N days' worth of compressed recordings, multiply the estimated number of recorded seconds of audio in one day by 8192 (bytes per second). And multiply this number by one of the following compression factors:

Compression Method	Compression Factor
GSM 6.1	0.203
True Speech	0.133
Opus (Mono)	0.25
Opus (Dual-channel)	0.50

The number is the amount of disk space required for one day's worth of compressed recordings.

Note

Enabling the Opus (Mono) and Opus (Dual-channel) compression formats requires additional resources on the Media Servers. See the *Interaction Media Server Technical Reference* and the Interaction Media Server Sizing Calculator for details, specifically when using Dual-channel, as it requires 1 additional point on the Media Servers. Enabling the Opus (Dual-channel) compression format requires additional disk space storage.

Multiply this by N, the number of days to keep the recording before moving it to another location or purged. We recommend that this figure be multiplied by an additional 1.5 to allow for greater than normal call volumes, other media types, and other unexpected events. Obviously, for sites with an extremely large volume of recorded calls, this might add significantly to the storage required, so use with discretion.

For example, an enterprise has 100 agents working 8 hours per day, and they are recording 50 minutes of calls per hour. That is, 100 agents, times (x) 50 minutes per hour, times eight hours equals 40,000 minutes per day. Converting to seconds, 40,000 minutes times 60 seconds per minute equals 2,400,000 seconds of recordings per day. Multiplying this number by the number of bytes per second (8192, before compression) and then multiplying the result by the compression factor used (for this example, 0.203), and converting to Gigabytes, equals 3.72 GB for one day's worth of compressed recordings. Multiplying by 30, for the number of days before recordings are moved or purged, equals 111.6 GB for 30 days' worth of compressed recordings. Multiplying this number by 1.5 for additional call volume makes a total disk space requirement of 167.4 GB for 30 days' worth of recordings.

Planning for Interaction Screen Recorder

Interaction Screen Recorder adds the screen recording capability to Customer Interaction Center (CIC). Synchronizing the audio recording of an agent with the workstation activity, screen recording provides a complete management tool for contact center supervisors, creating an additional level to quality monitoring in contact centers.

Interaction Screen Recorder is installed with Interaction Recorder during CIC installation, and it is configured in the Interaction Screen Recorder configuration dialog. If your CIC license includes the license for Interaction Screen Recorder, the Screen Recording node is displayed under Interaction Recorder in Interaction Administrator.

Careful sizing and planning for screen recording helps you to ensure success with Interaction Screen Recorder.

Licensing for Screen Recorder

Interaction Screen Recorder server requires two licenses: an Advanced Screen Recorder license (I3_FEATURE_RECORDER_ADVANCED), and an Interaction Recorder Session license (I3_LICENSE_SCREEN_RECORDER_SESSION). Interaction Screen Recorder Capture Client workstations also require the I3_LICENSE_SCREEN_RECORDER_SESSION license. Be sure you have purchased your Interaction Screen Recorder licenses prior to your CIC server installation, and that it is part of your CIC server license.

Software requirements

The following required software is installed on the CIC server during CIC installation.

- PureConnect Customer Interaction Center (CIC)
- Interaction Recorder Subsystem
- Maximum Supported Screen Recorder resolution is 1080p.

For exporting screen recordings, additional operating system software is required. For more information, see "[Exporting a Screen Recording](#)".

Interaction Screen Recorder Capture Client requirements

The hardware and software prerequisites for Interaction Screen Recorder Capture Client are the same as for all CIC Workstation Applications. Each agent's workstation requires the Interaction Screen Recorder Capture Client installed from the PureConnect Customer Interaction Center (CIC) .iso file. The CIC User Applications install is located in \Installs\ServerComponents. See the *CIC Installation and Configuration Guide* for details.

Installing Interaction Recorder

The Interaction Recorder Server subsystem components are installed on the CIC server as part of the CIC server installation process.

The Interaction Recorder components, including configuration modules in Interaction Administrator, are accessible when the CIC server license includes the Interaction Recorder Server Add-on license.

The Interaction Screen Recording node is accessible in the Interaction Recorder container in Interaction Administrator when the CIC server license includes the Advanced Screen Recorder license.

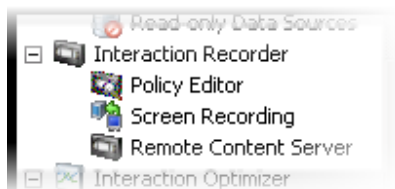

Interaction Recorder Installation Procedures

The Interaction Recorder installation consists of the following procedures:

- Installing CIC on the CIC server
- Running IC Setup Assistant
- Verifying the Media Server
- Validating Interaction Recorder configuration
- Installing Interaction Recorder Client for IC Business Manager

Install CIC on the CIC server

The Interaction Recorder Server subsystem components are installed on the CIC server as part of the CIC server installation process. To install CIC on the CIC server, see the *CIC Installation and Configuration Guide* for complete instructions.

Run IC Setup Assistant

You can configure Interaction Recorder when IC Setup Assistant is run on the CIC server, or you can configure Interaction Recorder later from Interaction Administrator.

If you use IC Setup Assistant to configure **Interaction Recorder Compressed Files Location**, the directory you specify is used to create an Interaction Recorder Retention Policy and determines where Interaction Recorder stores processed recordings by default. This default retention policy can be modified in Interaction Recorder Policy Editor. For more information, see "[Creating a Retention Policy](#)".

If IC Setup Assistant detects that the Interaction Recorder feature is included in your license, the Interaction Recorder configuration dialog is displayed during IC Setup Assistant configuration.

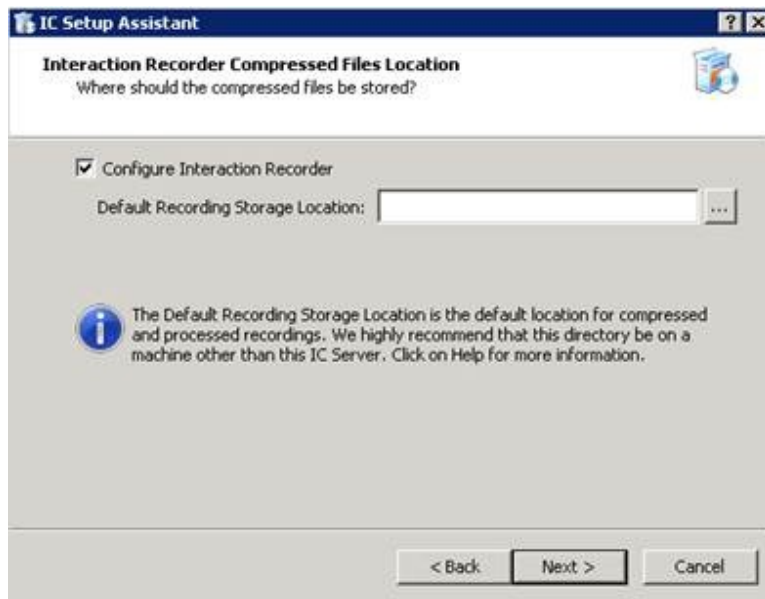

Configure Interaction Recorder

Select this check box to configure Interaction Recorder in IC Setup Assistant. You can choose to skip the Interaction Recorder configuration in Setup Assistant and instead perform the configuration post-installation, using the Interaction Recorder Policy Editor in Interaction Administrator.

Important Note If you do *not* perform the Interaction Recorder configuration in either IC Setup Assistant or Interaction Administrator, Interaction Recorder might not function properly.

Default Recording Storage Location

This directory is the default location where compressed and processed recordings are stored for Interaction Recorder.

We highly recommend that the compressed and processed recordings directory be:

- **On a machine other than the CIC server.** This is particularly important if the site generates a large number of recordings, or if there are multiple CIC servers generating recordings. In these cases, this directory must be on a non-IC Server machine to reduce potential performance and reliability problems with the CIC server. For customer sites with large Interaction Recorder installations, the directory size could be hundreds of gigabytes.
- **A valid UNC path.** This is necessary because there may be multiple CIC servers with Interaction Recorder enabled that will be storing recordings and accessing recordings in this location. The share for the UNC path should provide both read and write permissions to the CIC administrator account. If the site is using Recorder Remote Content Servers, then a local path can be used to cause the recordings to be stored on the Recorder Remote Content Server itself.

Note: If IC Setup Assistant cannot validate the specified path, a message might prompt you to ensure that the selected path exists and is shared before CIC is started.

For more information on configuring Interaction Recorder using IC Setup Assistant, see the *CIC Installation and Configuration Guide*.

Verify Media Server installation

After the CIC Sever is installed and configured, verify that the Media Server is installed and configured to communicate with the CIC server. For complete instructions, see the *Interaction Media Server Technical Reference* in the PureConnect Documentation Library.

Configure Interaction Recorder Settings

Validate Interaction Recorder settings in Interaction Administrator. For information on configuring Interaction Recorder, see [Configuring Interaction Recorder in Interaction Administrator](#).

Configure Interaction Screen Recorder

Configure the Interaction Screen Recorder settings in Interaction Administrator. For information on configuring Interaction Screen Recorder, see [Configuring Interaction Screen Recorder](#).

Install Interaction Recorder Client

After the Interaction Recorder installation and configuration process is complete, Install Interaction Recorder Client for IC Business Manager on workstations. For details, see [Installing Interaction Recorder Client](#).

Configure Interaction Desktop

Configure Interaction Desktop to add the Snip button to create Interaction Recorder Snippet Recordings. For details, see the Interaction Desktop (client) Help.

Configuring Interaction Recorder in Interaction Administrator

It is important that Interaction Recorder be configured properly in order for it to work correctly. After you have verified that the CIC server and Media Server are installed and configured, if you did not configure Interaction Recorder in IC Setup Assistant, you can configure it in the Interaction Recorder container in Interaction Administrator. It is also important to verify the Interaction Recorder configuration settings in Interaction Administrator. For example, the **Enable Recording** check box on the Recording Generation page must be selected for interactions to be recorded.

Interaction Recorder Configuration

Configure Interaction Recorder in Interaction Administrator in the Interaction Recorder Configuration dialog.

From the Interaction Administrator tree view, select the **Interaction Recorder** container, and in the right pane, double-click **Configuration**. The Interaction Recorder Configuration dialog is displayed.

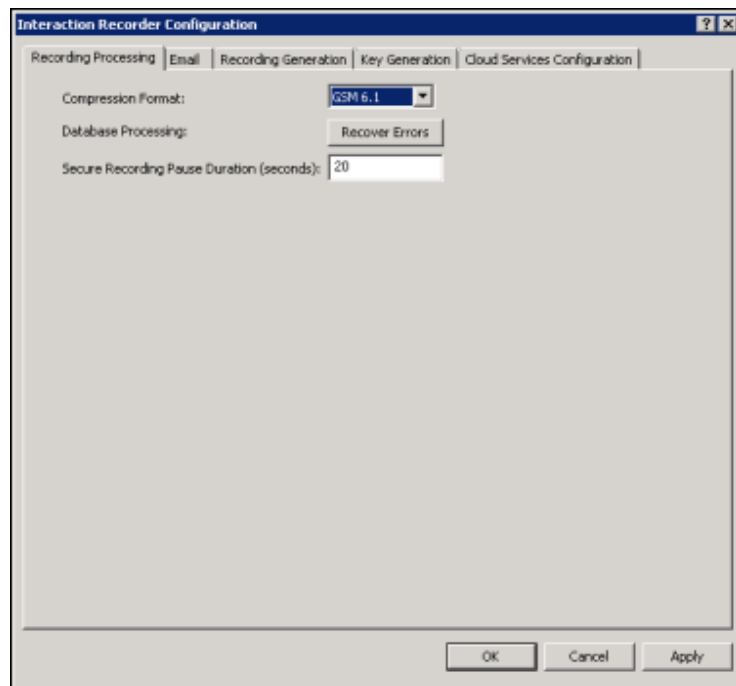

The Interaction Recorder Configuration dialog includes pages for Recording Processing, Email, Recording Generation, Key Generation, and Cloud Services Configuration.

Recording Processing

Use this page to configure recording processing.

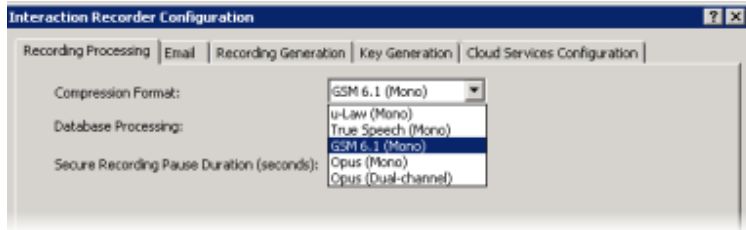

Compression Format

Select the compression format for recordings from the drop-down list. If you do not want recording compression, select **μ-law (Mono)**, and your recordings will remain in uncompressed μ-law format.

The available compression formats are:

- μ-law (Mono)
- True Speech (Mono)
- GSM 6.1 (Mono)
- Opus (Mono)
- Opus (Dual-channel)

Opus compression formats

When Opus Mono is configured, Interaction Recorder will request Telephony Services (TS) and the Media Servers generate a mono (1 channel) recording containing Opus audio data that will be wrapped in the SASF file container, similar to the other recording compression formats.

Dual-channel format will have separated 2-channels of audio data stored within the recording files, commonly referred to as stereo audio. When Opus Dual-channel is configured, Interaction Recorder will request Telephony Services (TS) and the Media Servers generate a dual-channel (stereo, 2-channel) recording with Opus audio data. The Opus audio data will be wrapped in the SASF file container, similar to the other recording compression formats.

When the Opus mono or Opus dual-channel compression formats are configured, if any pre-2017 R1 Media servers are also configured with the system, the recording compression format will be deprecated back to GSM 6.1, and errors will be logged stating that a non-supported Media server was found.

Opus recordings are *not* supported on Media servers before 2017 R1.

Important Note

Support for Opus recordings within Interaction Recorder and CIC requires version 2017 R2 or later client and server-side components. Earlier versions of the Interaction Recorder Remote Content Servers also do not support Opus recordings and will result in errors when archiving or exporting Opus recordings. Opus recordings can be generated within CIC and Interaction Recorder starting with 2017 R1 or later Media Servers.

Database Processing

Use this utility to initiate the recovery of failed database transactions. Clicking the **Recover Errors** button makes Interaction Recorder process the PMQ error files. This function can be used when your database has been unavailable and you want to get the data that has been logged into the PMQ error files into the database.

Secure Recording Pause Duration (seconds)

Enter the number of seconds to pause the audio and screen recording when an agent presses the Secure Pause button on the queue toolbar in the CIC clients. The default setting is 20 seconds.

Email

Use this page to configure the Reply To email address that Interaction Recorder Server uses when sending a recording from an Interaction Recorder Client.

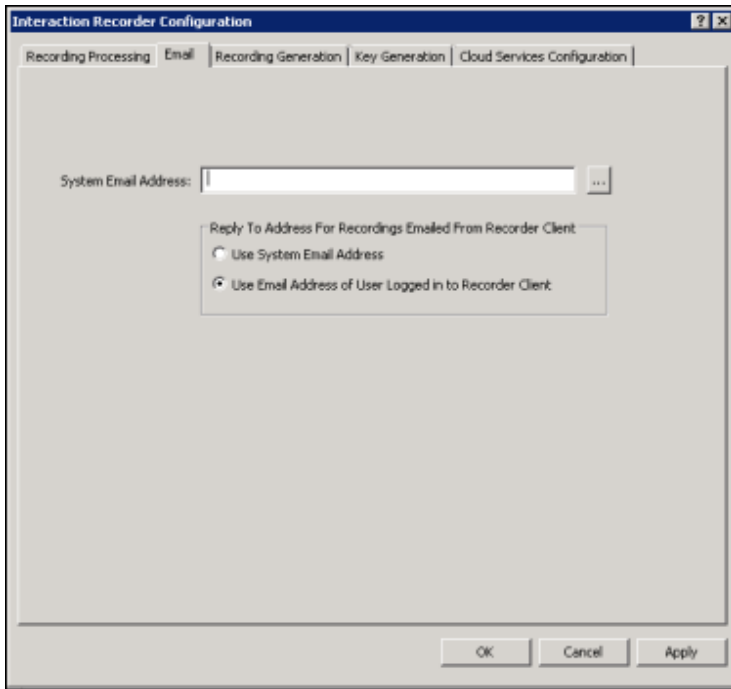

System Email Address

Enter the email address to be used as the Reply To (from) email address when a recording is emailed from Interaction Recorder Client.

- Select Use System Email Address to use the email addressed specified in the System Email Address box.
- Select Use Email Address of User logged on to Recorder Client to use the Recorder Client's user's email address.

Recording Generation

Use this page to configure Interaction Recorder's recording generation options.

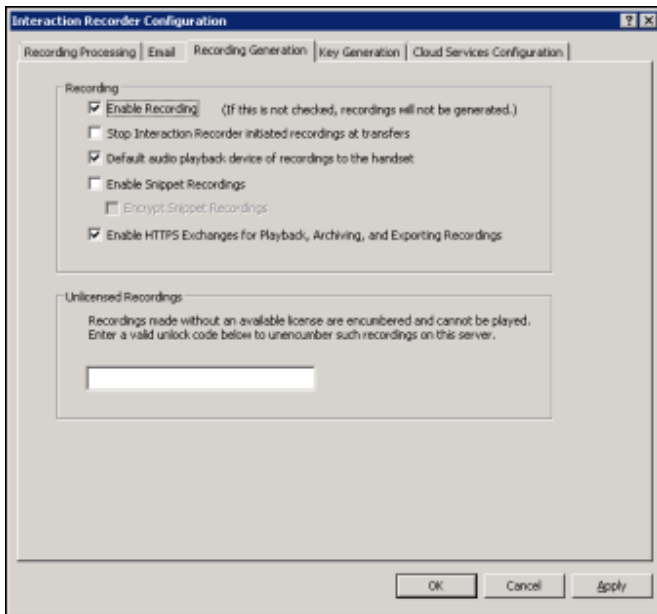

Recording box

Select the options in the Recording box to configure how Interaction Recorder server initiates recordings.

Enable Recording

Select the **Enable Recording** check box to record all interactions that qualify for recording based on Interaction Recorder Initiation Policies.

Note If this box is *not* selected, recordings will not be generated.

Stop Interaction Recorder initiated recordings at transfers

Select this check box to stop recording a call when it is transferred. If this box is selected, each transferred segment of a call will be its own recording and database entry.

If this box is clear (not selected), recording continues after the transfer. This applies only to calls that were defined to be recorded by the Initiation Policy. Also, if this box is not selected, it is not possible to play only a segment of the call or skip to a specific segment.

Default Audio playback device of recordings to the handset

Select this check box to set the handset as the default audio playback device for a recording. When listening to a recording, the audio playback device can be changed on the Audio menu in the Interaction Recorder Audio Playback window, in IC Business Manager.

Enable Snippet Recordings

Select this check box to allow Interaction Recorder Snippet Recordings in Interaction Desktop and Interaction Connect. To encrypt these recordings, select **Encrypt Snippet Recordings**.

Enable HTTPS Exchanges for Playback, Archiving, and Exporting Recordings

Select this check box to use HTTPS for: communication and traffic for playback, archiving; and exporting of call, chat, email, and social media recordings.

Note The S3 Bucket name cannot contain periods as Amazon's SSL wildcard certificate only matches buckets that do not contain periods.

Unlicensed Recordings box

Encumbered recordings cannot be played back. Recordings are encumbered if the user or station was not properly licensed for Interaction Recorder when the recording was made. When the **Recording is Encumbered** search attribute is used, Encumbered recordings are listed in the search results in the Interaction Recorder client search results view. The user or station that is not properly licensed is displayed in the Local Party Name column.

To unencumber a recording, first fix the licensing for the user or station that has encumbered recordings. Next, contact PureConnect Customer Care to get an unencumber key to unlock the encumbered recording that needs to be played back. Then in the Unlicensed Recordings field, enter a valid unlock code to unencumber the encumbered recordings on the server.

Key Generation

Use this page to generate a Master Key for Recording Encryption. A Master Key securely protects Recording Keys (media keys), which are generated every time a media file is recorded.

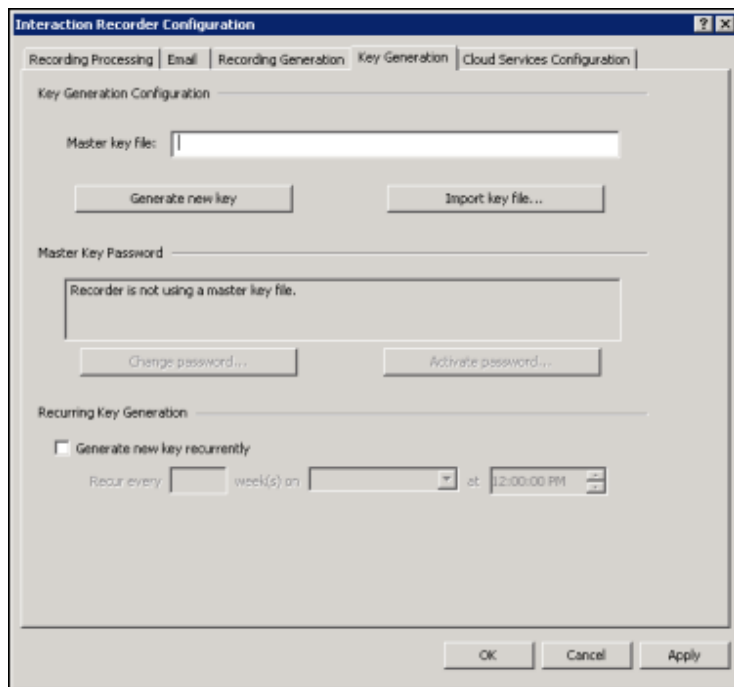

Key Generation Configuration box

The first step in generating a Master Key is to specify the location of the Master Key file. Master Keys are stored in the Master Key file and the Master Key file is encrypted using the Master Key Password.

Master Key File

In the Master Key File box, specify a location and file name for the Master Key File. When configuring this field, press F1 for specific Help on Key Generation configuration. For more information on recording encryption, see [Appendix A: Recording Encryption](#).

Generate New Key

Click **Generate New Key** to manually generate a new Master Key. When you click **OK** or **Apply** for the first time, an initial Master Key is created and appended to the Master Key file. You can also use this button to manually create a new key and append it to the Master Key file. For additional information on administering the Master Key File, see [Appendix A: Recording Encryption](#).

Import Key File

Click **Import key file** to import a key file and merge it with the existing Master Key File. An Open dialog is displayed to specify the location of the file to be imported. When the key file is successfully imported, a confirmation message is displayed. If the key file import fails, an error message is displayed. When the Master key file is password protected, you will be prompted to enter the Master Key Password.

Import key file can be used to import a 3.0 Recorder key file to 2015 R1 and later. It can also be used to import a 2015 R1 or later key file to a 2015 R1 or later server, to replace a bad key file. For example, if a switchover pair did not share a key file location.

Master Key Password box

Use the Master Key Password box to password protect the Master Key File and securely encrypt master key data. To create, change, or deactivate a Master Key Password, the user must be assigned the Security Right **Master Key Password Administrator**.

Important Note

PureConnect Customer Care cannot recover encrypted recordings if a Master Key Password is lost.

Change Password

Click **Change password** to create a new Master key password or to change the current password.

Deactivate/Activate Password

When you create a new Master key password or change the password, the password is Activated, and the Deactivate password button is displayed. To deactivate the password, click **Deactive password**. To activate the password, click **Activate Password**, and on the Activate Password dialog, type the password and click **Activate**.

Recurring Key Generation box

Use the Recurring Key Generation box to configure parameters to automatically generate a new Master Key on a recurring basis.

Generate New Key Recurrently

- To automatically generate a new Master Key, select the **Generate new key recurrently** check box.
- To schedule an automatic key generation: in the **Recur every** box, type the number for the weekly recurrence; in the drop down-list, select the day of the week to generate the key; and in the time field, select the time of day to run the key generation.

For more information on recording encryption and key generation, see [Appendix A: Recording Encryption](#).

Cloud Services Configuration

Use this page to configure Interaction Recorder's Cloud Service options.

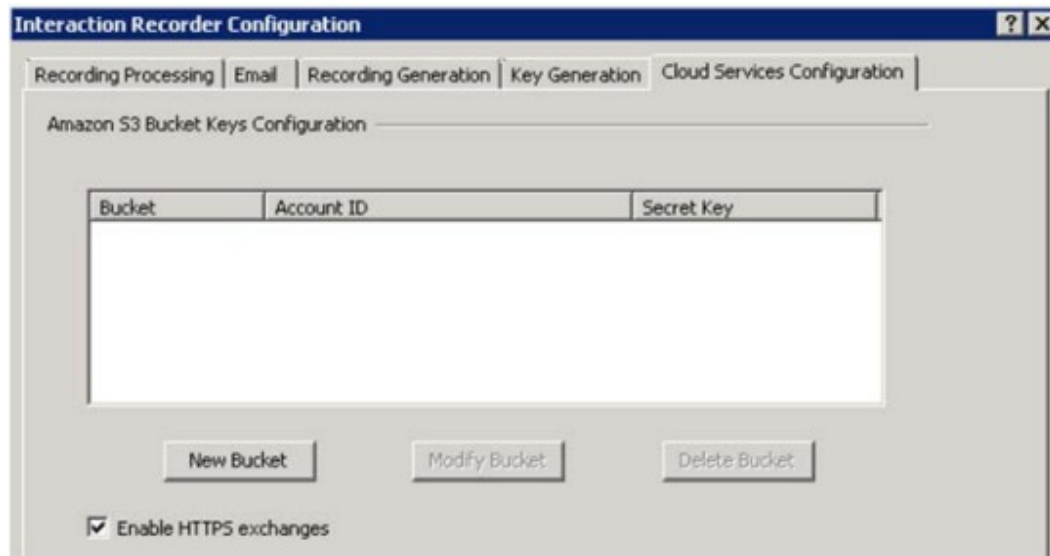

Using Amazon Simple Storage Service

To use the Amazon Simple Storage Service (Amazon S3) to store your recordings, you will need an Amazon Web Services (AWS) account. You will be downloading your AWS security access key to use when creating a New Bucket in Interaction Recorder's Cloud Services Configuration. For information on Amazon Simple Storage Service, see Amazon Web Services at <http://aws.amazon.com/s3>

Here are the steps to create your AWS security access key.

1. Open an AWS account.
2. Under your AWS account, go to Security Credentials. Create your security access key, and download the key. The download is a .csv file that contains the AWSAccessKeyID (20 characters) and the AWSSecretKey (40 characters). Be sure to download this file as these are the keys you will be using to create a New Bucket in Interaction Recorder Configuration.

Next, create an AWS S3 bucket to store your recordings.

1. Go to the AWS Services tab and select S3.

2. Create an S3 Bucket.
3. If you choose, you can create a folder within the S3 bucket for recordings.

Now, using the **AWS Policy Generator**, grant permissions for the following AWS S3 Object Operations, from the **Actions** drop-down list.

- GetObject
- PutObject
- DeleteObject

Amazon S3 Bucket Keys Configuration Box

To use Amazon S3 when creating storage and archive Retention Policies in Policy Editor, first configure your bucket keys in Interaction Recorder Configuration in Interaction Administrator.

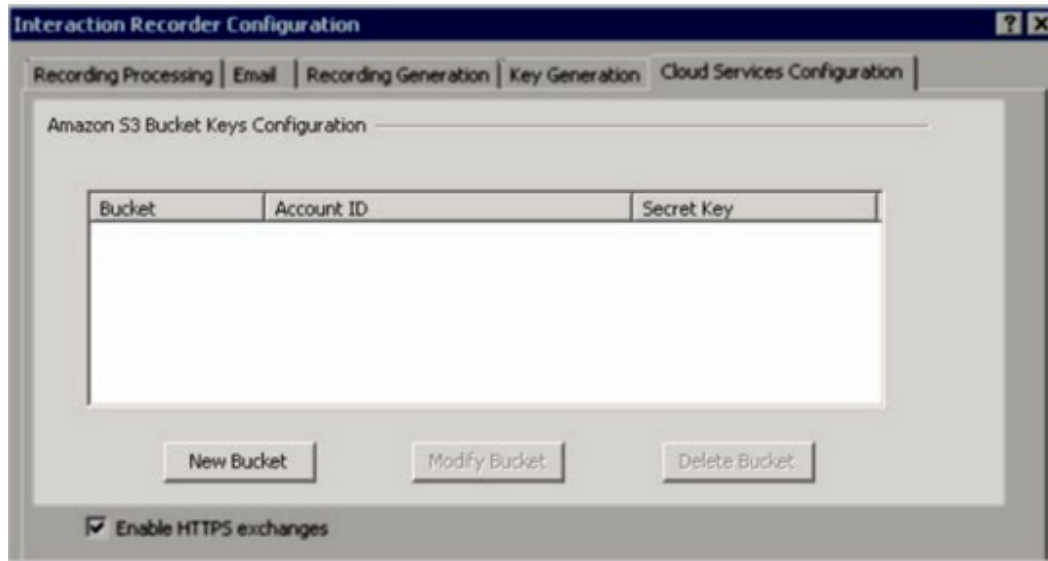

New Bucket

Follow these steps to configure a new bucket in Cloud Services Configuration.

1. Click **New Bucket**. The **S3 Keys Editing** dialog is displayed.
2. On the S3 Keys Editing dialog, type a **Bucket name**.
3. Type the **Account ID** and **Secret Key** from your AWS account downloaded key file. The Account ID is the AWSAccessKeyId, and the Secret Key is the AWSSecretKey.
4. Select the Region Endpoint.
5. Click **Test** to validate the proper access level for the specified account credentials.

Modify Bucket

To modify an existing bucket, select the bucket and click **Modify Bucket**. The S3 Keys Editing dialog is displayed. You can modify the **Account ID** and the **Secret Key**.

Delete Bucket

To delete an existing bucket, select the bucket and click **Delete Bucket**.

Note

You can also create a new bucket when creating a Retention Policy in Policy Editor.

Enable HTTPS exchanges

All Amazon S3 communication uses HTTPS or HTTP protocol. Select the **Enable HTTPS exchanges** check box for HTTPS protocol.

Note The S3 Bucket name cannot contain periods as Amazon's SSL wildcard certificate only matches buckets that do not contain periods.

Configuring Interaction Screen Recorder

Use the Screen Recording Configuration dialog to set the capture settings for Interaction Screen Recorder.

From the Interaction Administrator tree view, in the **Interaction Recorder** container, select **Screen Recording**. In the right pane, double-click **Configuration**. The Screen Recording Configuration dialog is displayed.

Note

Maximum Supported Screen Recorder Resolution is 1080p.

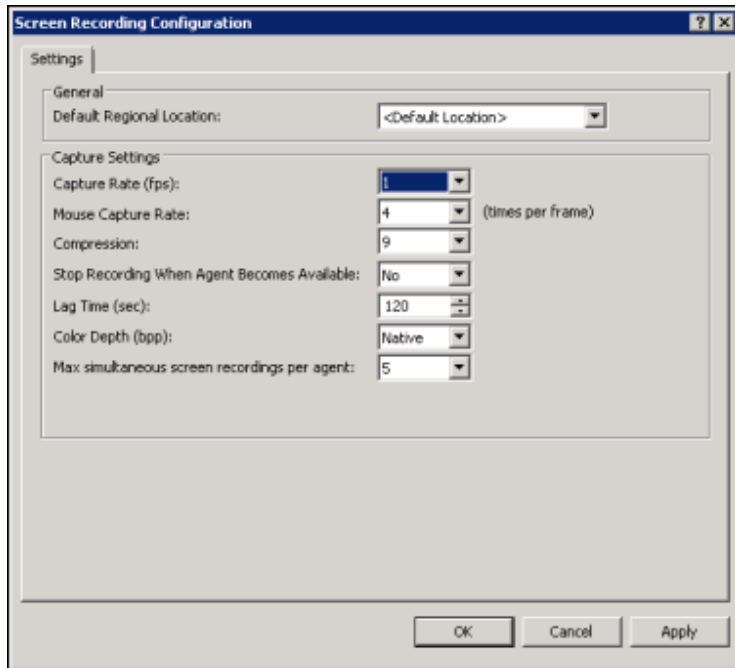

Use the **Settings** page to configure Screen Recording.

General box

Use the General box to set the Default Regional Location.

Default Regional Location

From the drop-down list, select the location for which region screen recordings will use if Interaction Recorder cannot determine the region based on the interaction or station.

Capture Settings box

Use the Capture Settings box to configure the settings for Screen Recording.

Capture Rate (fps)

Use the drop-down list to select the capture rate in frames per second (fps). The default is 1 fps. The available values are: 0.25, 0.5, 1, 2, 4, or 8 fps. Refer to the following chart for Capture Rate Settings.

Capture Rate Settings	
Setting	Equals
0.25	1 frame every 4 seconds
0.5	1 frame every 2 seconds
1	1 frame per second
2	2 frames per second
4	4 frames per second
8	8 frames per second

The higher the setting the more storage used.

Mouse Capture Rate

Use the drop-down list to select the mouse capture rate in times per frame. The default is 4. The available values are: 1, 2, 4, 8, or 16.

Compression

Use the drop-down list to select the compression rate. The default is set to 9. The available options are any integer from 0-no compression, to 9-maximum compression.

Stop Recording When Agent Becomes Available

Configure this setting to control the recording of an agent's screen. Set the value to **Yes** to stop the recording when the agent becomes available. When the value is set to **Yes** the recording stops even if the agent is in lag time.

If the value is set to **No**, the recording continues when the agent becomes available; the number of seconds the recording continues is set by Lag Time.

Lag Time (sec)

Use this box to set the lag time, in seconds, at the end of an interaction for screen recording. The Interaction Recorder Server terminates a screen recording when the lag time expires. The default is **120** seconds (2 minutes). The available options are any integer from 0 to 3600 seconds (60 minutes).

Note

As a result of internal batch processing, your agents might experience up to an additional 10 seconds of lag time during screen recordings. For example, if you set the lag time to be 15 seconds your agents might experience a lag time from between 15 seconds to 25 seconds during screen recordings.

Color Depth (bpp)

Use the drop-down list to set the color depth in bits per pixel (bpp). The default is set to Native. The available options are: Native, 8, 16, and 24 bit.

Max simultaneous screen recordings per agent

Use the drop-down list to set the value for the maximum number of simultaneous screen recordings per Interaction Screen Recorder Capture Client. When the maximum limit is reached, every new screen recording stops the oldest one in progress.

Installing Interaction Recorder Client

Interaction Recorder, an add-on module for IC Business Manager, is used to search and play back media recordings such as phone calls, web chats, emails, Social Media interactions, and screen recordings. Interaction Recorder is also used to Score recordings and search and view scorecards. Interaction Quality Manager is used to create questionnaires. Interaction Quality Manager is a content group of Interaction Recorder, and both workspaces are installed as part of the installation.

Planning for Installation

The Interaction Recorder Client is installed on client workstations using the **IC Business Manager Applications Workstation** install from the PureConnect Customer Interaction Center (CIC) .iso file. The install is located in \Installs\ServerComponents. The install creates an IC Business Manager shortcut in the PureConnect folder of the Start Menu and also creates a shortcut on the Windows desktop.

Licenses

The following licenses are required for Interaction Recorder Client and Interaction Quality Management.

License Feature	License Name	Description
Interaction Recorder Client Access	I3_ACCESS_RECORDER_CLIENT	Access Recorder Client This license allows user access to the Interaction Recorder Client for IC Business Manager. It allows a user to create and execute Searches and playback recordings in Interaction Recorder Client.
Interaction Quality Manager	I3_ACCESS_RECORDER_QUALITYMONITORING	Access Recorder Quality Monitoring This license is required for quality evaluation of recordings. This license allows Questionnaires and Scoring functionality for a user in Interaction Quality Manager.

The Interaction Recorder Client Access license must be available to view the Interaction Recorder Client in IC Business Manager.

You can view the licenses on your system in Interaction Administrator by clicking the **File** menu, and then click **License Management**. Confirm that you have the necessary Interaction Recorder Client licenses on the **Licenses** page.

Install Interaction Recorder Client

Interaction Recorder Client is installed on client workstations using the IC Business Manager Applications Workstation install.

After the CIC installation, run the IC Business Manager Applications install on administrator or manager workstations to install IC Business Manager Applications. Interaction Recorder Client module is available in IC Business Manager when the Interaction Recorder Client Access license is assigned.

The install creates two IC Business Manager shortcuts: one in the PureConnect folder of the Start Menu and one on the Windows desktop.

To run the Interaction Recorder Client install on a workstation, follow these steps.

1. If you have not done so already:
 - a. Download the CIC 2015 R1 or later .iso file from the Product Downloads page at <https://help.genesys.com/pureconnect/secure/Downloads.aspx>
 - b. Copy the .iso file to a file server (non-IC server) with a high-bandwidth connection to the workstation(s) on which you will be running the CIC 2015 R1 or later installs.
 - c. Mount the .iso file and share the contents to make them accessible to the workstation(s) on which you will be running the CIC 2015 R1 or later installs.
2. Navigate to the \Installs\ServerComponents directory on the file server.
3. Copy the IC Business Manager Applications .msi file, for example, **ICBusinessManagerApps_2018_R1.msi**, to the workstation on which you plan to run this install and double-click to launch it.
The IC Business Manager Application Setup wizard starts.

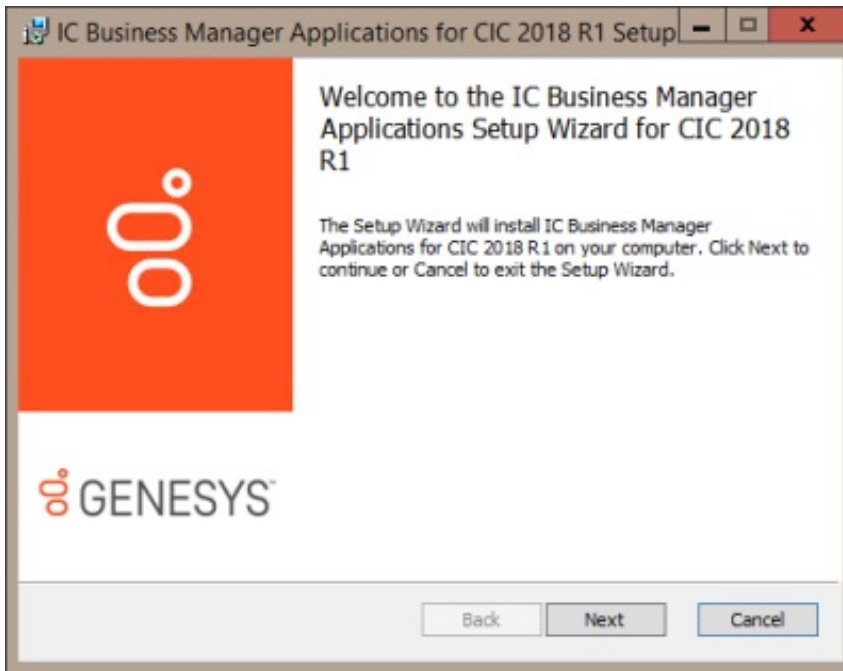

4. On the Welcome screen, click **Next**. As Setup wizard guides you through the installation, the Custom Setup screen is displayed.

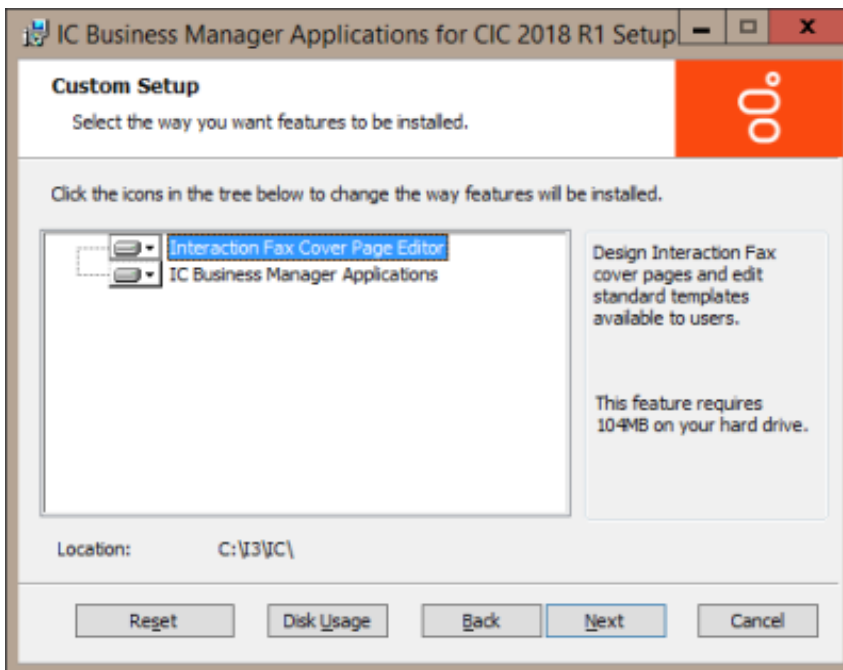

5. On the Custom Setup screen, select the way you want features to be installed. To accept the default features to be installed, click **Next**. The IC Server Name screen is displayed.

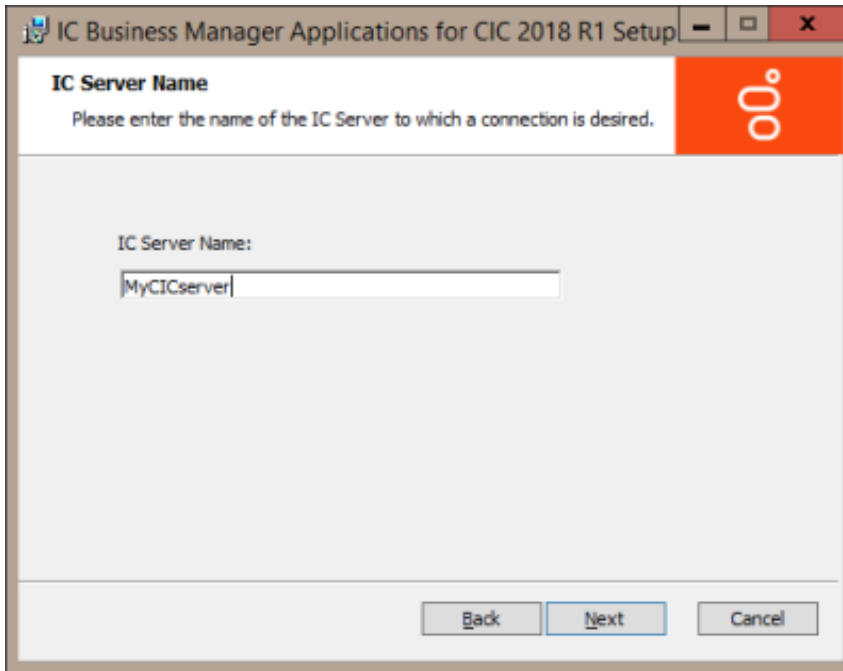

6. On the IC Server Name screen, type the name of the CIC server in the IC Server Name box, and click Next. The Ready to install IC Business Manager Applications screen is displayed.

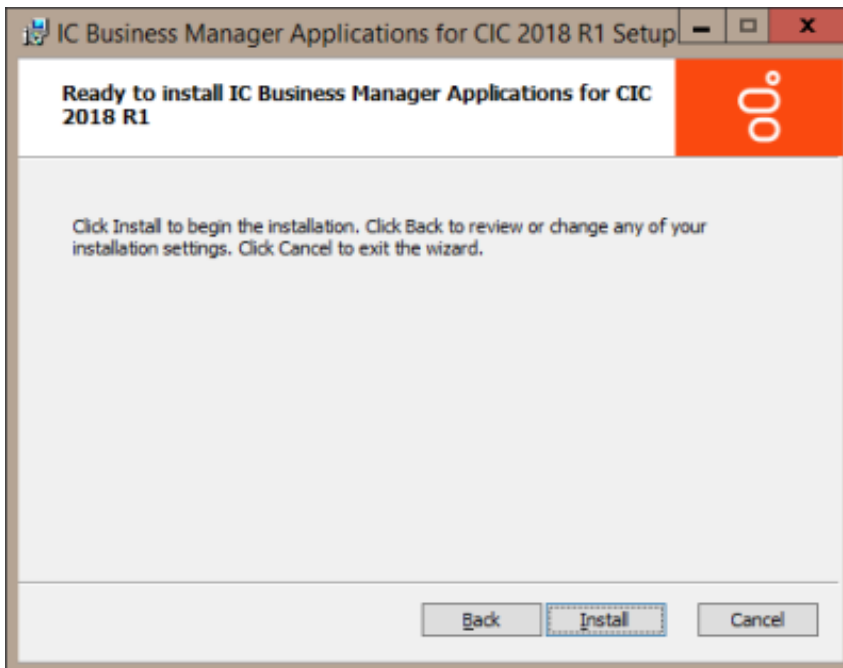

7. On the Ready to install IC Business Manager Applications screen, click Install. The Installing IC Business Manager Applications screen is displayed.

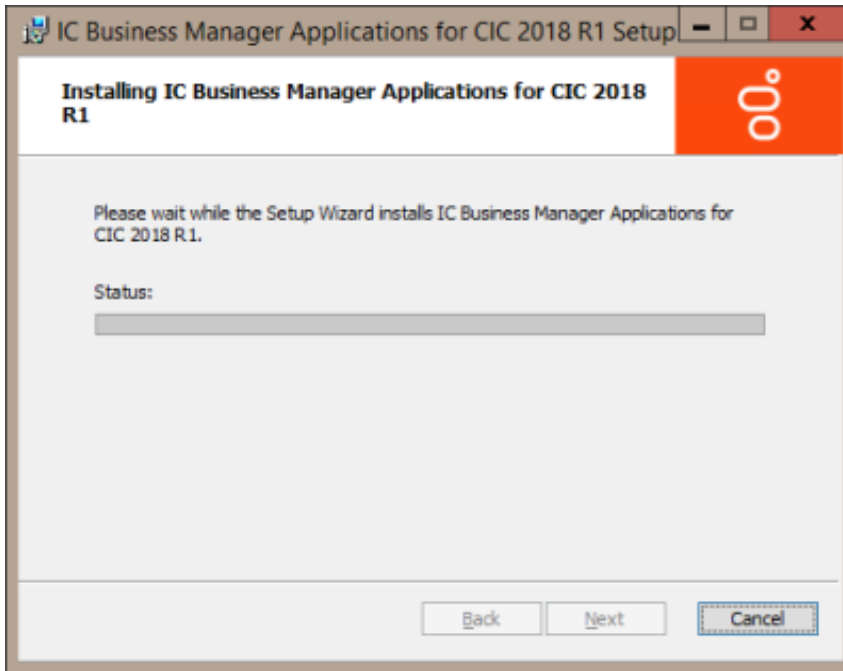

8. Setup Wizard installs IC Business Manager Applications. When the installation is complete the Completed the IC Business Manager Applications Setup Wizard screen is displayed.
9. Click Finish to exit the Setup Wizard.

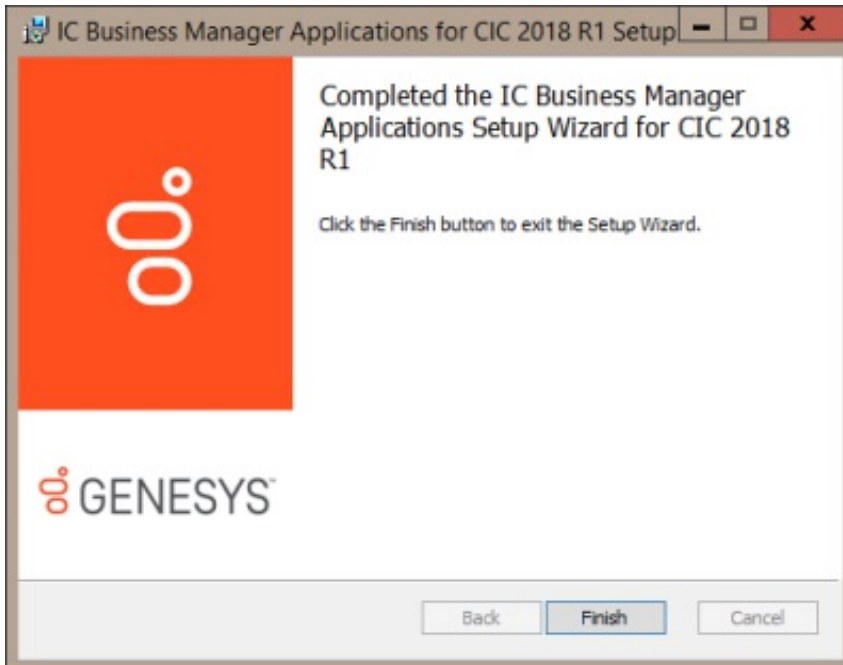

Starting IC Business Manager

During IC Business Manager installation, a shortcut was installed on the desktop



Double-click the shortcut to start IC Business Manager, or click **Start**, point to **All Programs**, and then click PureConnect. In the PureConnect folder, click **IC Business Manager**.

When prompted, log on to IC Business Manager using your CIC server credentials. IC Business Manager opens.

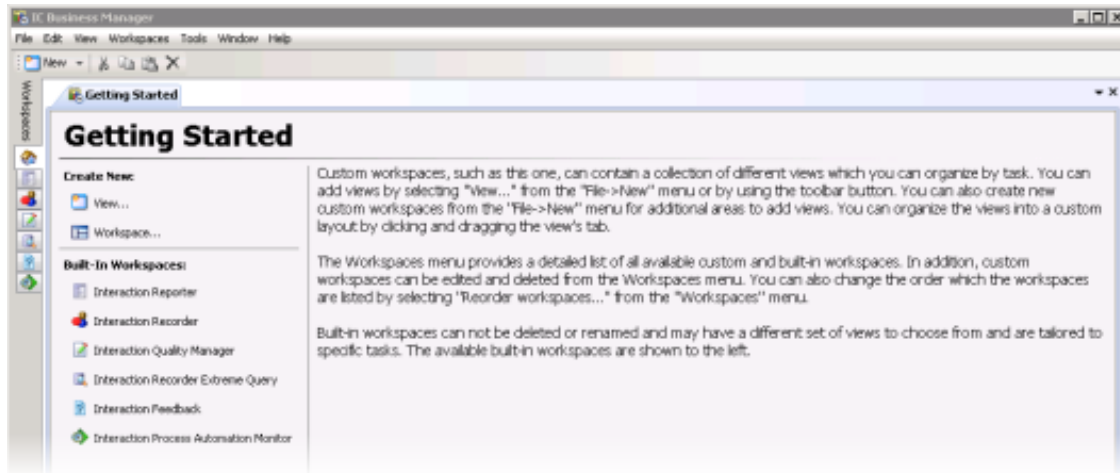

To open Interaction Recorder, click the **Interaction Recorder** tab in the **Workspaces** menu.

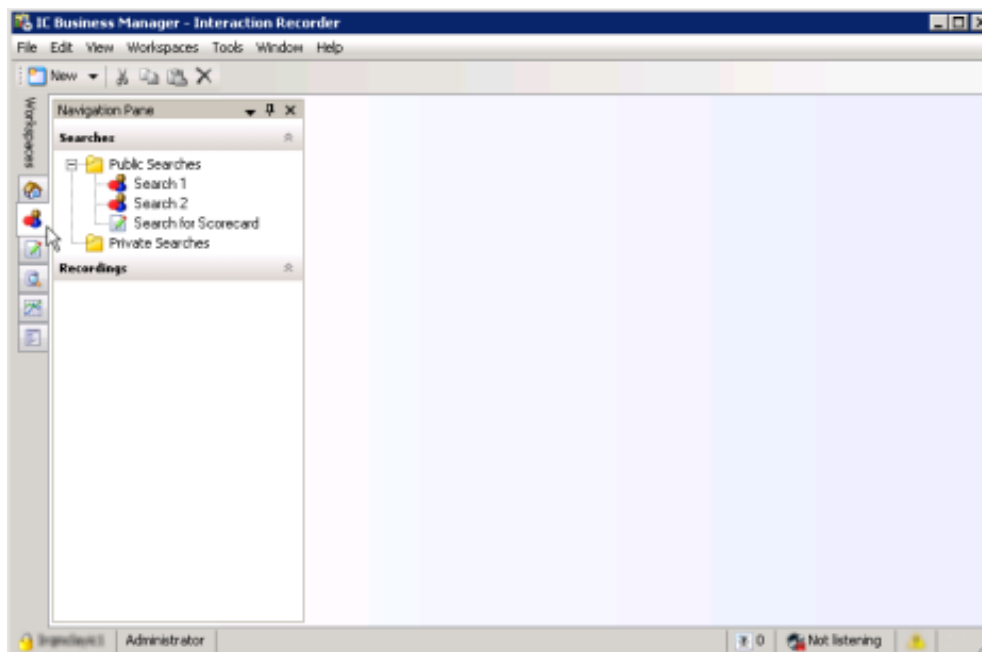

For information on working with the Interaction Recorder, see [Using Interaction Recorder Client](#).

Installing Interaction Screen Recorder

Interaction Screen Recorder, an Interaction Recorder feature, adds the screen recording capability to Customer Interaction Center (CIC). There are two processes that make Interaction Recorder Screen Recorder work: Interaction Recorder Server process and the Interaction Screen Recorder Capture Client workstation service.

Interaction Recorder Server

Interaction Recorder Server is installed as part of the CIC server installation process. The Interaction Recorder Server controls the capture clients and synchronizes screen recordings with agent audio recordings during playback.

Interaction Screen Recorder Capture Client

The Interaction Screen Recorder Capture Client, which is installed on the agent workstation, records agent's screens. Screen recordings can be associated with phone call and web chat interactions. Screen Recorder captures the full-screen desktop on the Interaction Screen Recorder Capture Client machine. The Capture Client service is installed on all Interaction Screen Recorder Capture Client machines, and is responsible for recording the screen and compressing the recording.

Planning Interaction Screen Recorder Capture Client Installation

The Interaction Screen Recorder Capture Client is installed on client workstations using the **IC User Applications Workstation** install from the PureConnect Customer Interaction Center (CIC) .iso file.

QoS feature requirement

In CIC 4.0, a new QoS driver was developed to more closely integrate with Customer Interaction Center. Depending on your installation, a QoS selection screen might appear prompting you to choose the QoS driver installation, recommending that the PureConnect QoS driver be installed.

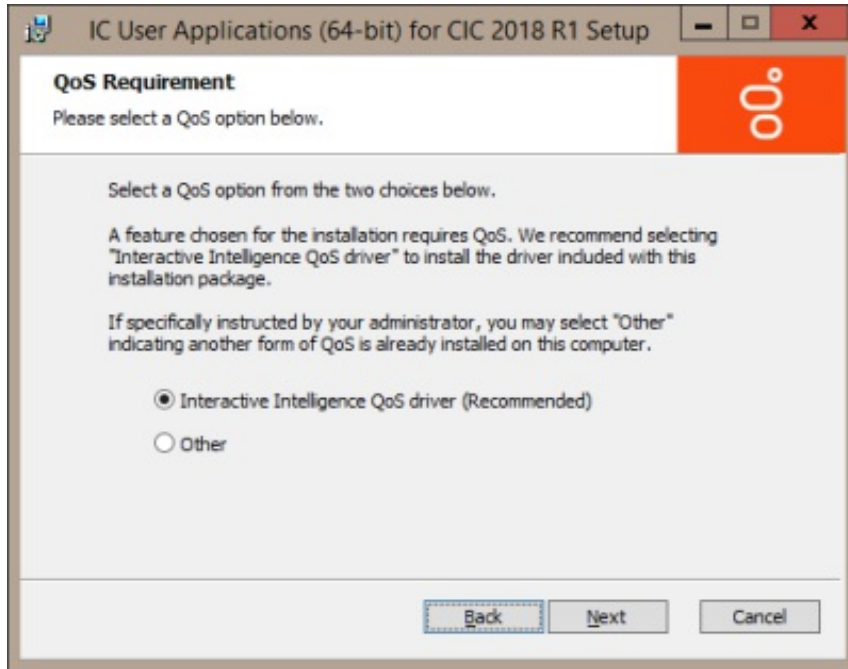

In the **QoS Requirement** screen, select **PureConnect QoS driver** to add the PureConnect certificate to the Trusted Publishers list and install the PureConnect QoS driver.

For more information about the PureConnect QoS driver, see the PureConnect Knowledge Base (KB) article, **Modify properties for the ININ QoS driver installation**, at:

https://genesyspartner.force.com/customercare/pkb_Home?id=kA50B0000008R5H

Licenses

Interaction Screen Recorder Client requires the following feature license.

License Feature	License Name	Description
Screen Recorder Session	I3_LICENSE_SCREEN_RECORDER_SESSION	<p>Interaction Screen Recorder Session</p> <p>Port based license, required to record agent desktop screen activity. Interaction Screen Recorder also requires Interaction Recorder server product and must be added to an Interaction Recorder Add-on license.</p> <p>This is the Interaction Recorder Screen Recorder license for Server and Capture Clients.</p> <p>A Screen Recorder Port License is needed for every screen that needs to be recorded simultaneously. In other words, if you need to record 20 screens at the same time, 20 port licenses are required.</p>

You can view the license on your system in Interaction Administrator by clicking the **File** menu, and then click **License Management**. Confirm that you have the necessary Interaction Screen Recorder license on the **Features** page.

Install Interaction Screen Recorder Capture Client

After the CIC installation, Interaction Screen Recorder Capture Client is installed on client workstations using the PureConnect Customer Interaction Center (CIC) .iso file, ICUser Applications Workstation install.

The IC User Applications Workstation install can be run on client workstations using IC User Applications (64-bit) Setup Wizard, or the install can be run from a command line.

IC User Applications (64-bit) Setup Wizard installation

After the CIC installation, run the IC User Applications install on client workstations that require screen recording capability.

1. If you have not done so already:
 - a. Download the CIC 2018 R2, or later, .iso file from the Product Downloads page at <https://help.genesys.com/pureconnect/secure/Downloads.aspx>
 - b. Copy the .iso file to a file server (non-CIC server) with a high-bandwidth connection to the workstation(s) on which you will be running the CIC 2018 R2 or later installs.
 - c. Mount the .iso file and share the contents to make them accessible to the workstation(s) on which you will be running the CIC 2018 R2 or later installs.
2. Navigate to the `\Installs\ServerComponents` directory on the file server.
3. Copy the IC User Applications .msi file, for example, `ICUserApps_64bit_2018_R2.msi`, to the workstation on which you plan to run this install and double-click to launch it.
4. The IC Business Manager Application Setup wizard starts.

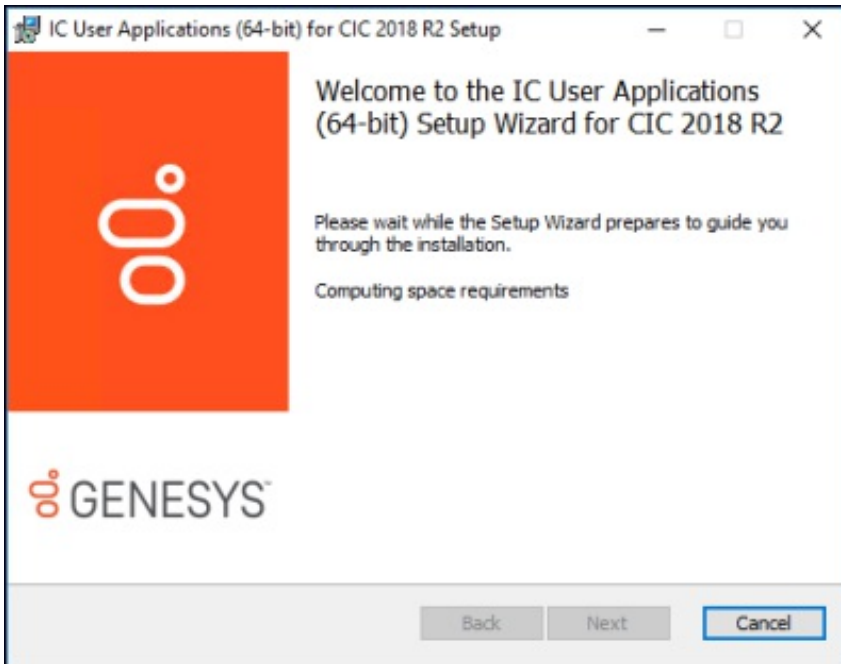

5. On the **Welcome** screen, click **Next**. As Setup wizard guides you through the installation, the **Custom Setup** screen is displayed.

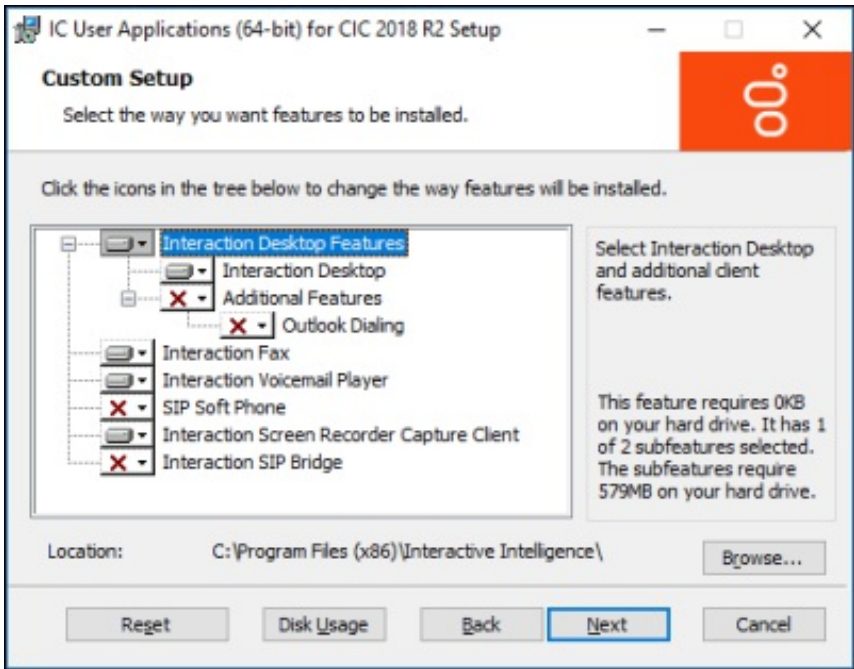

- On the Custom Setup screen, select the way you want features to be installed. Click the Interaction Screen Recorder Capture Client icon.

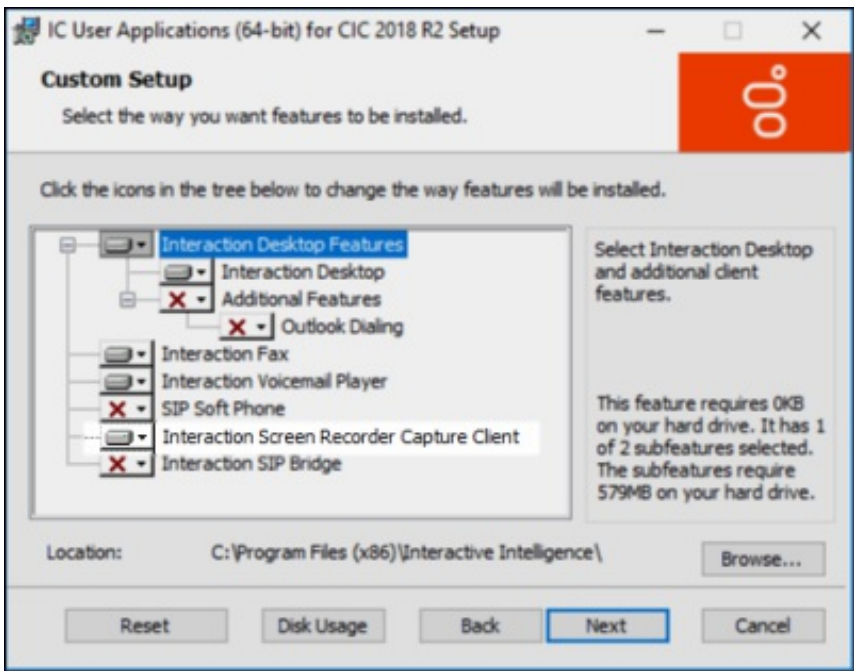

The installation options are displayed.

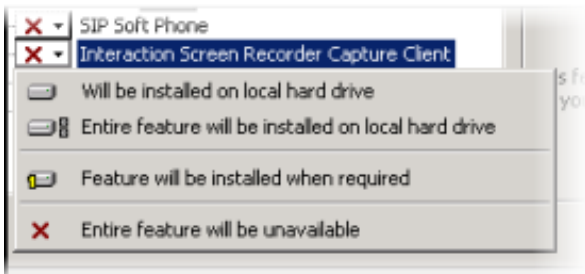

Note:

When you click Next, the QoS Requirement screen might be displayed, recommending you select the PureConnect QoS driver. See "[QoS feature requirement](#)" for more information.

- Select Entire feature will be installed on local hard drive, and click Next.

The IC Server Name screen is displayed.

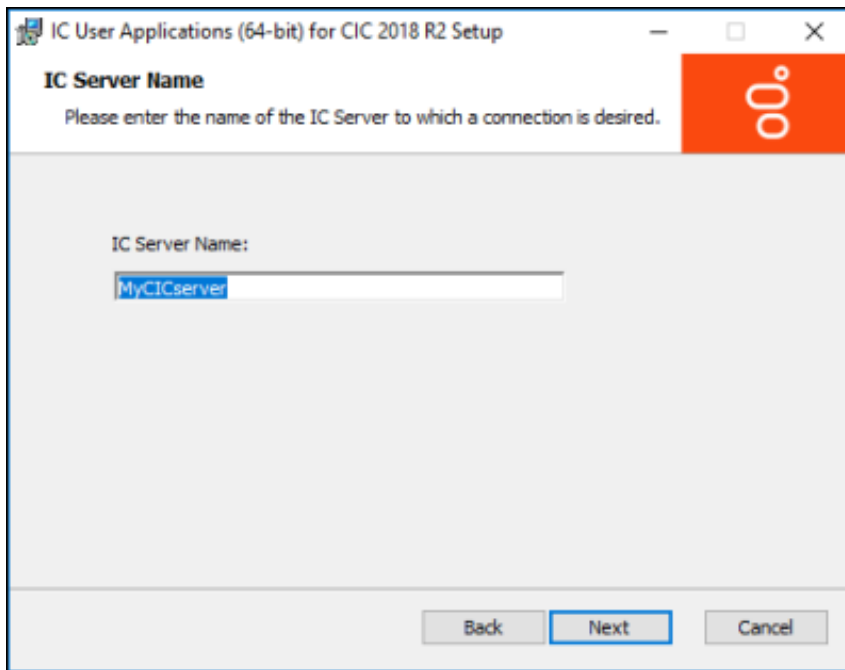

8. On the **IC Server Name** screen, type the name of the IC Server in the **IC Server Name** box, and click **Next**. The **HTTP Connection Configuration** screen is displayed.

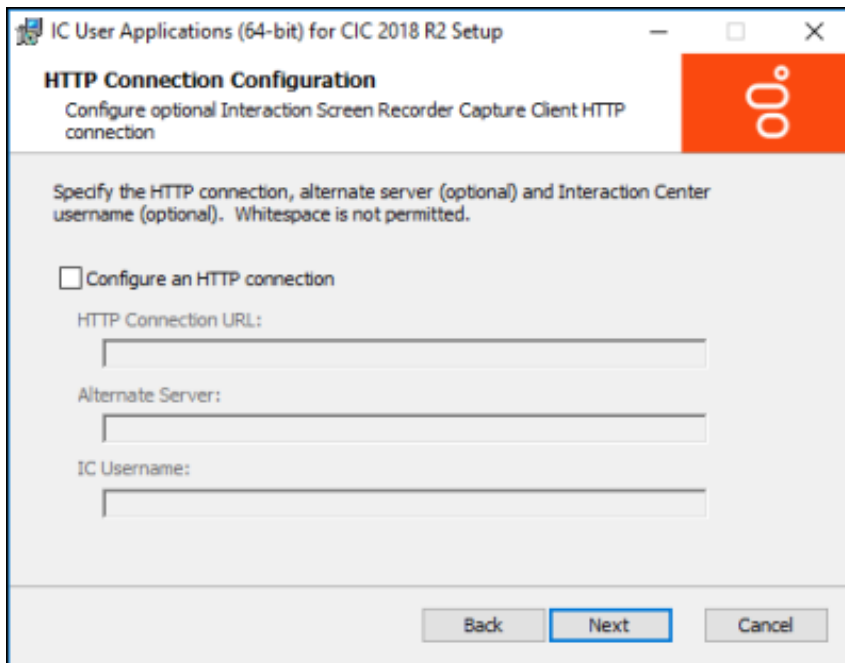

9. To specify the options for the HTTP connection, select the **Configure an HTTP connection** check box. The HTTP connection options are available. Do not use spaces when entering options.

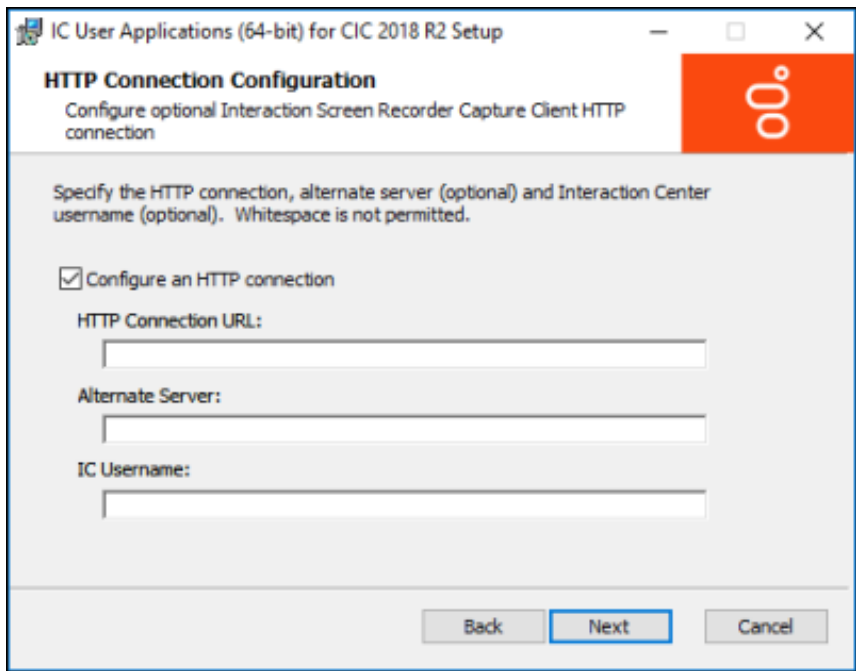

- **HTTP Connection URL** - Specify the HTTP connection URL in the form `https://SERVER:PORT`
 - **Alternate Server** - You can optionally specify the name of the alternate CIC server
 - **IC Username** - You can optionally specify an IC username for the agent requiring screen recording.
- Click **Next**. The **Ready to install IC User Applications** screen is displayed.

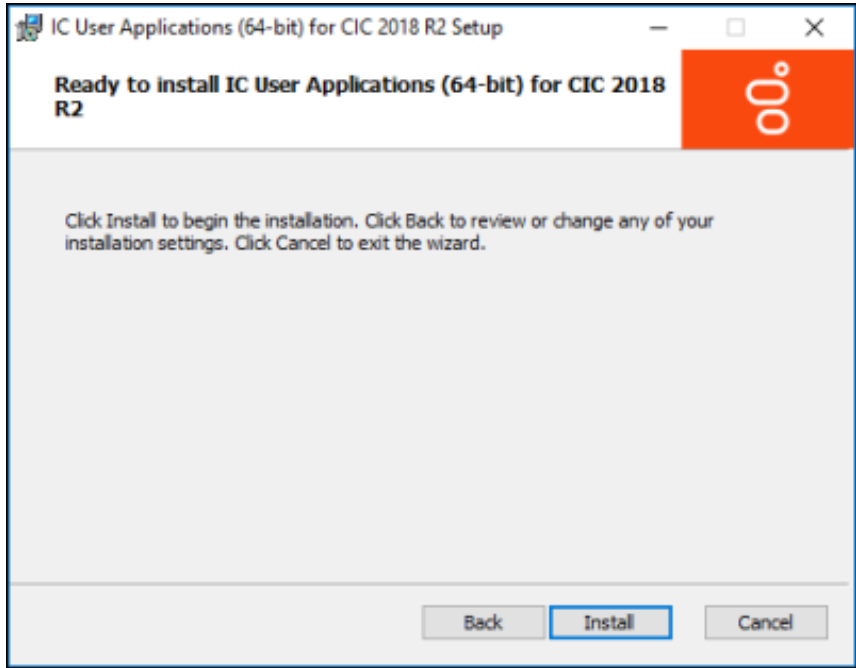

10. On the **Ready to install IC User Applications** screen, click **Install**. The **Installing IC User Applications** screen is displayed.

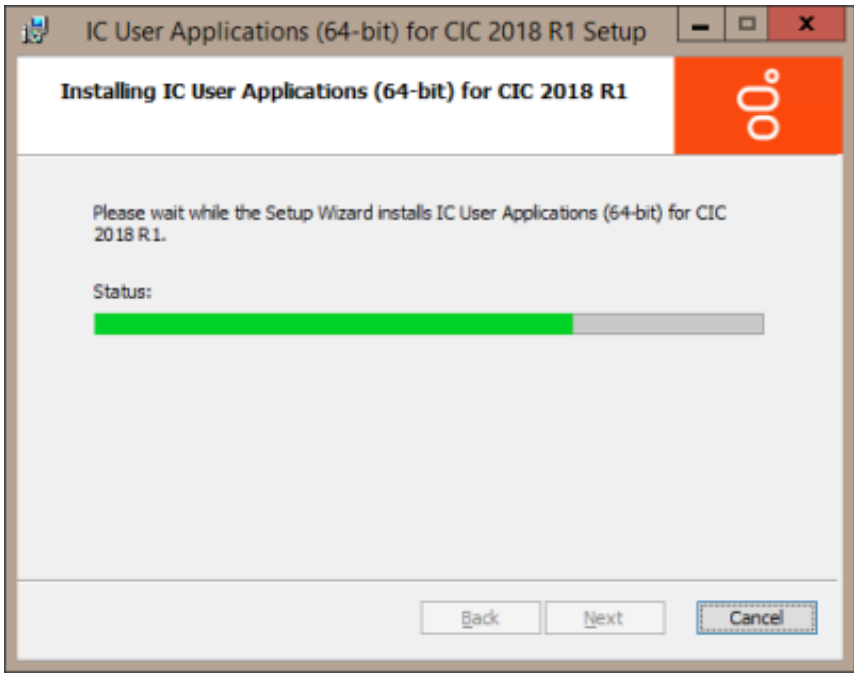

- 11. Setup Wizard installs IC User Applications, including the Interaction Screen Recorder Capture Client. When the installation is complete the **Completed the IC User Applications Setup Wizard** screen is displayed.

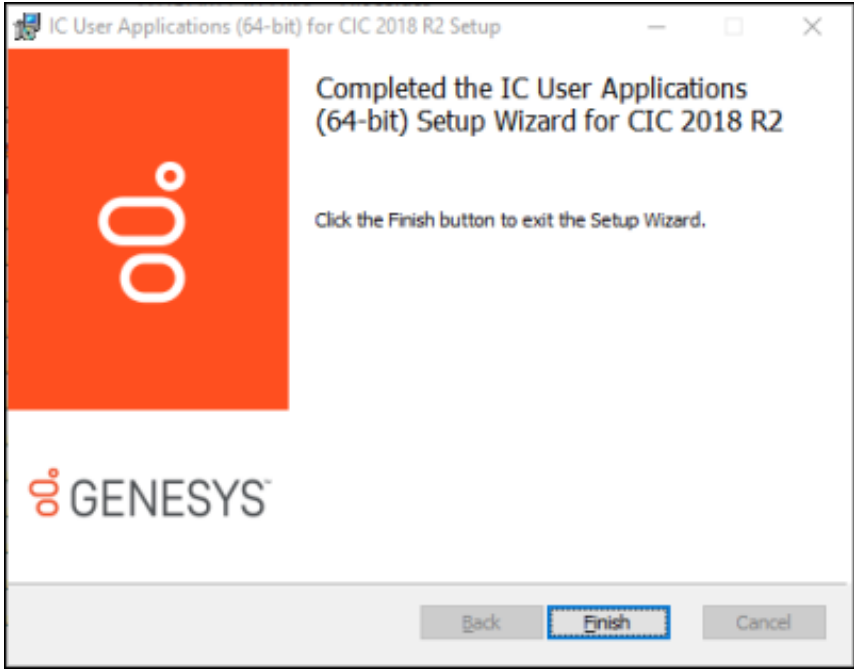

- 12. Click **Finish** to exit the Setup Wizard.

IC User Applications (64-bit) command-line installation

You can use the command-line option when you are only installing the Interaction Screen Recorder Capture Client, and no other features. This command-line option does not have a user interface for choosing other features or options.

After the CIC installation, use the Windows Command Prompt to install the Interaction Screen Recorder Capture Client on client workstations that require screen recording capability.

1. If you have not done so already:
 - a. Download the CIC 2018 R2, or later, .iso file from the Product Downloads page at <https://help.genesys.com/pureconnect/secure/Downloads.aspx>.
 - b. Copy the .iso file to a file server (non-IC server) with a high-bandwidth connection to the workstation(s) on which you will be running the CIC 2018 R2 or later installs.
 - c. Mount the .iso file and share the contents to make them accessible to the workstation(s) on which you will be running the CIC 2018 R2 or later installs.
2. Navigate to the \Installs\ServerComponents directory on the file server.
3. Copy the IC User Applications .msi file, for example, `ICUserApps_64bit_2018_R2.msi`, to the workstation on which you plan to run this install.

4. From a Windows Command prompt, type:

```
Msiexec /i <path to MSI> INSTALL_SRCC_FOR_ICCONNECT=1 /qn
```

The install completes, with no user interface. The configuration options for Interaction Recorder Capture Client are contained in the config.xml file. For an example of config.xml file, see [Appendix I: Interaction Screen Recorder Capture Client config.xml file](#).

Silent Login for Capture Client

In order for an agent not to be prompted to sign in to Capture Client, a configurable silent option is available that will attempt to silently log in to the Capture Client service with any cached CIC credentials that are available for the specified user. If your IC Server configuration supports Single Sign-on (SSO), using the silent login will also attempt to provide SSO authentication to the IC Server, if the user has previously supplied SSO credentials when logging into the Capture Client or another SSO-aware CIC client application.

To enable the silent option, add the line `<parameter name="silent" />` to the screen capture client config.xml file.

The silent option can also be enabled by modifying the command-line parameters from the shortcut that the screen capture client executable runs from, by specifying the "-silent" option.

For information on how to automatically log in to Screen Recorder Capture Client using Single Sign On (SSO) credentials, see [Appendix G: Setup Automatic Login with SSO in Screen Recorder](#).

Using Policy Editor

About Interaction Recorder Policy Editor

Policy Editor is a single, simple, user interface for creating Interaction Recorder policies that manage recordings. Policy settings for recordings include: *What* are the interactions to be recorded; *Where* recordings are stored and archived, and how long they are retained; and *Who* can access, play, score, export, and archive recordings.

Use Policy Editor to create:

- Initiation policies for determining *What* interactions are recorded
- Retention policies for deciding *Where* recordings are stored and archived, and how long they are retained
- Security policies for managing *Who* can access, play, score, export, and archive recordings

About the Policy Editor User Interface

Interaction Recorder Policy Editor provides a simple, straightforward, user interface to configure and update Interaction Recorder Policies. The interface includes menus, pages, toolbars, and panes for that make it easy for you to navigate when creating Policies.

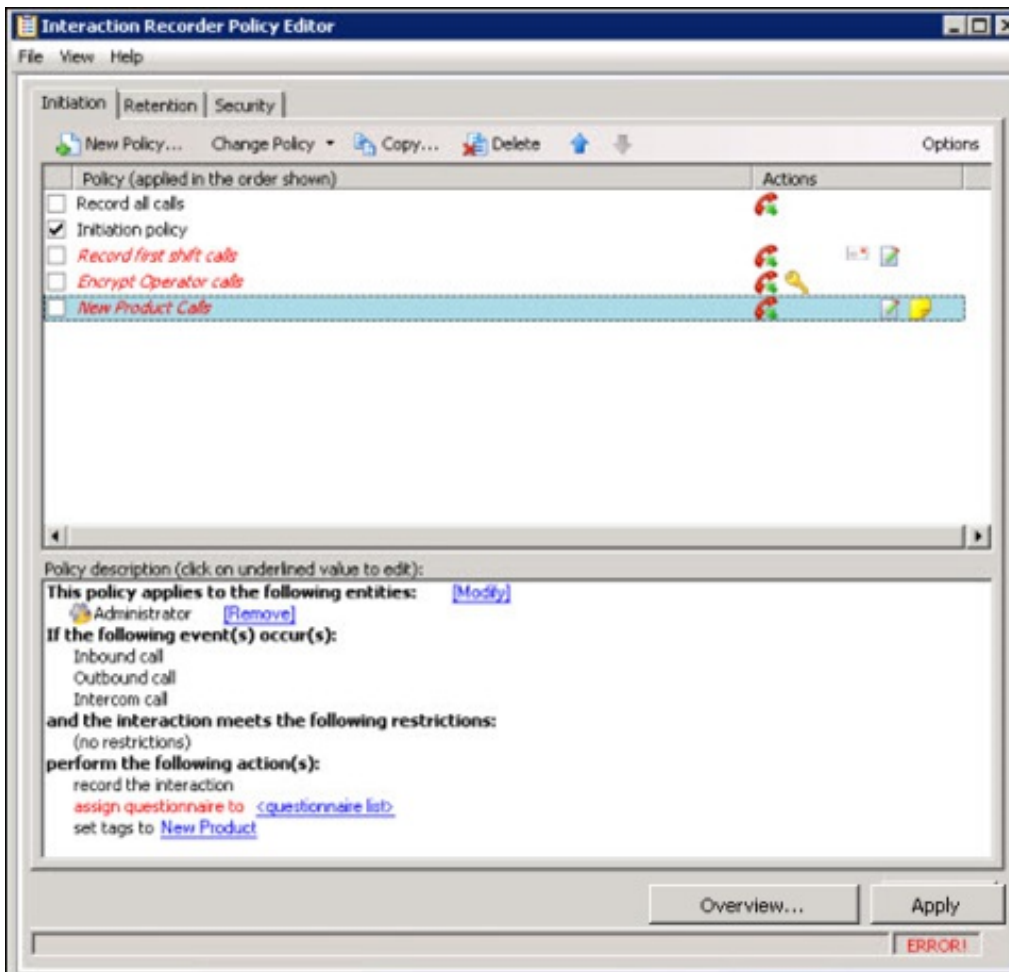

Start Policy Editor

1. From **Interaction Administrator** under **Interaction Recorder**, click **Policy Editor**.
2. In the **Policy Editor** pane, double-click **Configuration**.

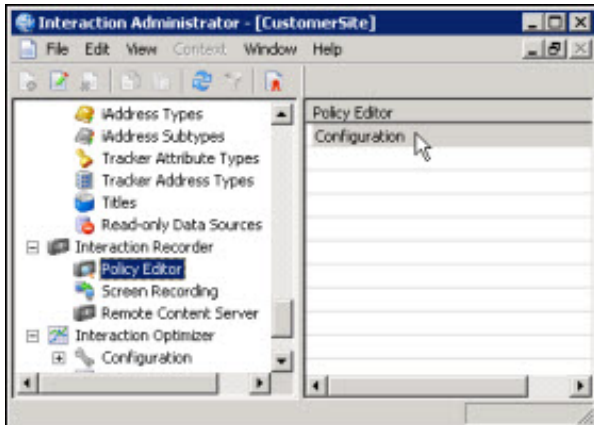

3. The **Interaction Recorder Policy Editor** dialog is displayed.

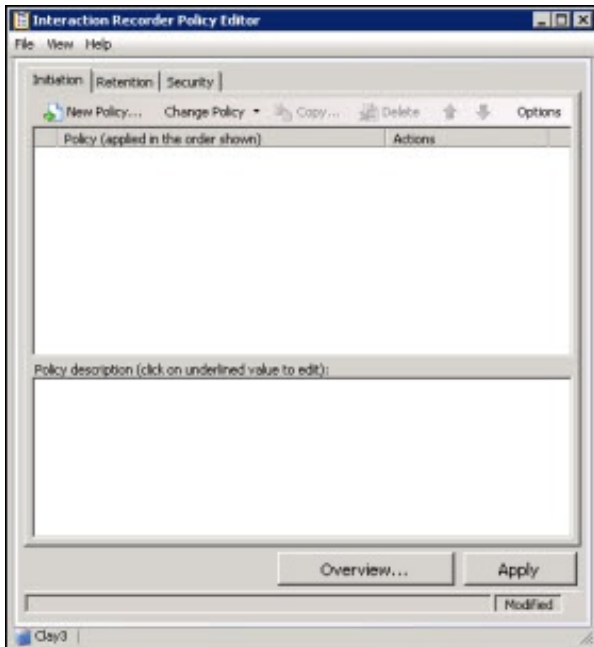

4. Click the **Initiation**, **Retention**, or **Security** tab to display the page.

Creating an Initiation Policy

Create an Initiation Policy to tell Interaction Recorder *What* interactions to record. Initiation policies are created in Interaction Administrator under Interaction Recorder on the Policy Editor Configuration dialog, on the **Initiation** page.

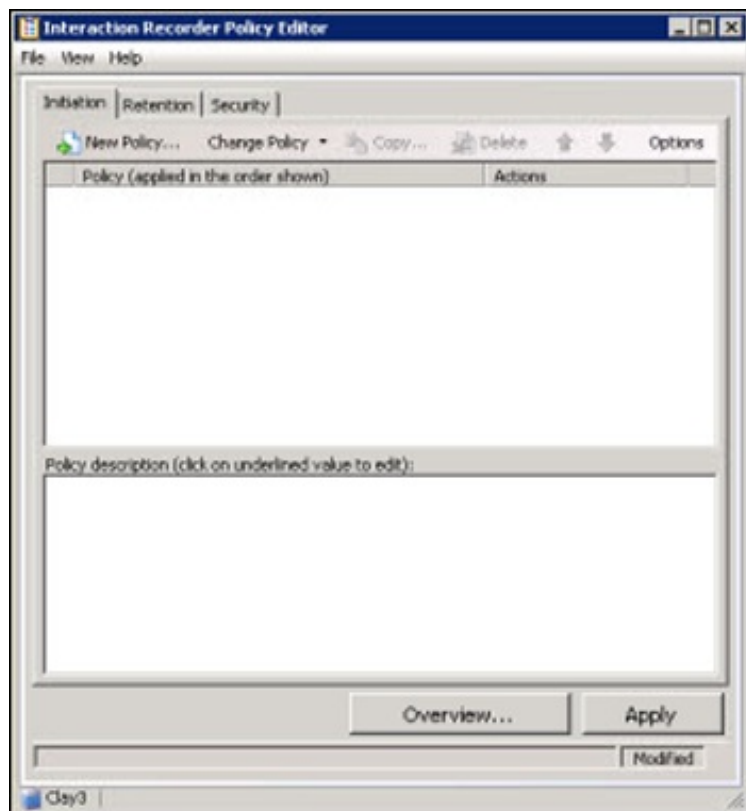

Create a New Initiation Policy

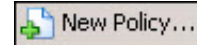

To create a new Initiation Policy, on the Initiation page toolbar, click **New Policy**. The Edit Initiation Policy dialog is displayed, beginning with Step 1.

A screenshot of the "Edit Initiation Policy" dialog box. The title bar says "Edit Initiation Policy". Below the title bar is a "Name" field containing "New Policy". Underneath is a section titled "Step 1: Applies to the following entities". It contains a "Search for entities:" text box, a large empty list box, and a "Legend" box on the right. The legend lists "Agent", "Workgroup", "Role", "Station", and "Line" with corresponding icons. Below the legend is a "Remove" button. At the bottom left of this section is a checkbox labeled "Applies to all entities". Below this is a "Policy description (click on underlined value to edit):" section. The description reads: "This policy does not apply to anyone: If the following event(s) occur(s): (Any interaction) and the interaction meets the following restrictions: (no restrictions) No actions have been defined". At the bottom of the dialog are four buttons: "Cancel", "< Back", "Next >", and "Finished".

Step1: Applies to the following entities

Use this page of the Edit Initiation Policy dialog to apply the policy to entities. You can assign any of the following entities: Agent, Workgroup, Role, Station, or Line.

Applying Policies to Entities

You can apply this policy to all entities or you can select specific entities to apply the policy to.

Apply policy to all entities

To apply this policy to all entities:

1. In the **Name** field, type a descriptive name for the policy.
2. In the **Step 1: Applies to the following entities** box, the **Filter** legend lists the entity types and their icons. To apply this policy to all entities, select the **Applies to all entities** check box.

In the **Policy description** pane, the entity description, **This policy applies to everyone** is displayed.

Apply policy to specific entities

To apply this policy to specific entities:

1. In the **Name** field, type a descriptive name for the policy.
2. Be sure the **Applies to all entities** check box is clear.
3. In the **Step 1: Applies to the following entities** box, the **Filter** legend lists the entity types and their icons: **Agent, Workgroup, Role, Station, and Line**. To reduce the number of entities returned in the search results, clear the check boxes for the entities you do not want to include in the search. For example, if you know the entity you are searching is a **Role**, clear the other check boxes.
4. To apply this policy to specific entities, click in the **Search for entities** field.
5. In the **Search for entities** field, begin typing an entity name, for example the name of an **Agent, Workgroup, Role, Station, or Line**. Entity names that match are displayed in a pop-up window. Note that the entity type icon is displayed next to the entity name.
6. In the pop-up window, click the entity to apply this policy to. The entity is displayed in the entity list box.

In the **Policy description** pane, the entity is added below the **This policy applies to the following entities** descriptor.

7. Continue adding entities using the **Search for entities** field.

Removing Entities from a Policy

To remove an entity from this policy, from the entity list box, select an entity and click **Remove**. The entity is removed from the list box and also removed from the policy descriptor **This policy applies to the following entities** in the **Policy description** pane.

Completing applying entities

The **Policy description** pane is updated as Initiation Policy settings are added and updated.

When the **Policy description** for applying Initiation Policies to entities is complete, click **Next**. The **Edit Initiation Policy** dialog, **Step 2: Restrict to these events** is displayed.

The screenshot shows the 'Edit Initiation Policy' dialog box. At the top, the title is 'Edit Initiation Policy' with a close button (X). Below the title is a 'Name' field containing 'New Policy'. The main section is titled 'Step 2: Restrict to these event(s)' and contains a list of events with checkboxes:

- Inbound call connected
- Outbound call connected
- Intercom call connected
- Inbound chat connected
- Intercom chat connected
- Inbound email
- Outbound email
- Inbound social conversation
- Inbound social direct message

Below the list is the 'Policy description (click an underlined value to edit):' section. The text reads: 'This policy does not apply to anyone: If the following event(s) occur(s): (Any interaction) and the interaction meets the following restrictions: (no restrictions) No actions have been defined'. At the bottom, there are four buttons: 'Cancel', '< Back', 'Next >', and 'Finished'.

Step 2: Restrict to these events

Use this page of the **Edit Initiation Policy** dialog to select the type of interactions to be recorded. Interactions for the following events are recorded by default: Inbound call connected, Outbound call connected, Intercom call connected, Inbound chat connected, Intercom chat connected, and Inbound email. Use Step 2 to restrict the recording of the interactions for these events.

Recording Any Interaction

To record any interaction, be sure **(Any interaction)** is displayed in the **Policy description** pane, below the **If the following events occur**. For **Any interaction** to be recorded, all check boxes for the events in Step 2 must be clear.

Restricting Recording to Specific Events

You can restrict recording to certain interactions by selecting specific events in the **Step2:Restrict to these events** box. To restrict the recording to specific events:

1. In the **Step 2: Restrict to these events** box, select the events check boxes for the type of interaction you want to record. For example, if you select **Inbound call connected**, all inbound call interactions will be recorded. You can select one or more events for the types of interactions you want to record. In the **Policy description** pane, the interactions to record are added below the **If the following events occur** descriptor.
2. Continue selecting events for which you want to record interactions.

Completing Interactions to be Recorded

When you have completed configuring the settings for interactions to be recorded, verify that the interactions you want to record are listed in the **Policy description** pane under the **If the following events occur** descriptor. Depending on your selections, the following events are displayed:

- Inbound call
- Outbound call
- Intercom call
- Inbound chat
- Intercom chat
- Inbound email
- Outbound email
- Inbound social conversation
- Inbound social direct message

After you have verified your selections, click **Next**. The **Edit Initiation Policy** dialog, **Step3: Select criteria** is displayed.

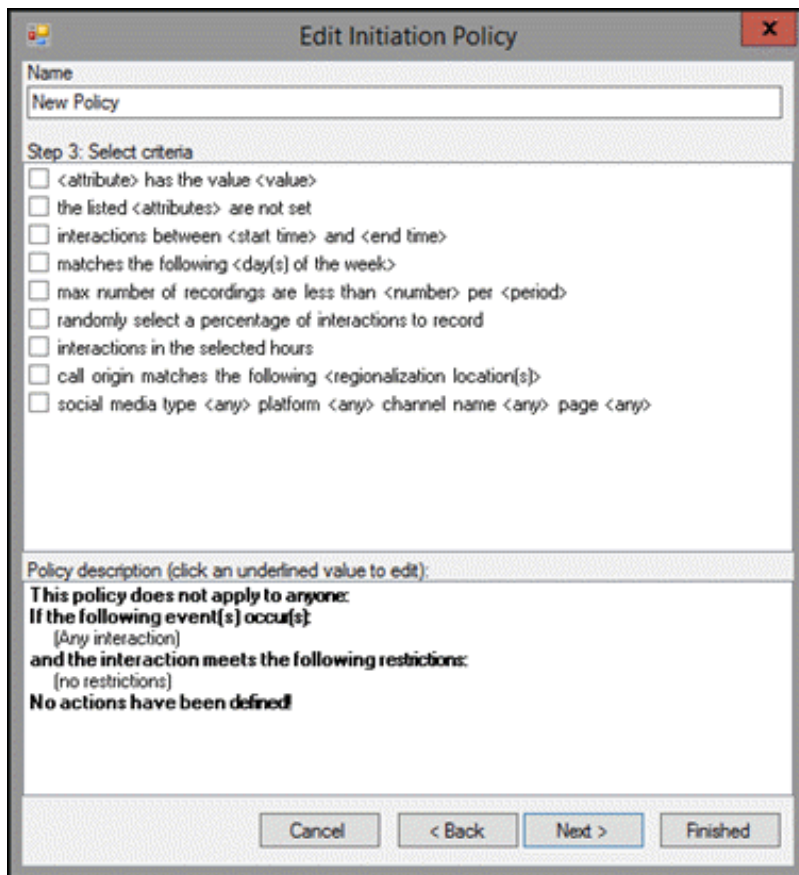

The screenshot shows a dialog box titled "Edit Initiation Policy" with a close button (X) in the top right corner. The dialog is divided into several sections:

- Name:** A text field containing "New Policy".
- Step 3: Select criteria:** A list of eight criteria, each with an unchecked checkbox:
 - <attribute> has the value <value>
 - the listed <attributes> are not set
 - interactions between <start time> and <end time>
 - matches the following <day(s) of the week>
 - max number of recordings are less than <number> per <period>
 - randomly select a percentage of interactions to record
 - interactions in the selected hours
 - call origin matches the following <regionalization location(s)>
 - social media type <any> platform <any> channel name <any> page <any>
- Policy description (click an underlined value to edit):**

This policy does not apply to anyone:
If the following event(s) occur(s):
(Any interaction)
and the interaction meets the following restrictions:
(no restrictions)
No actions have been defined
- Buttons:** "Cancel", "< Back", "Next >", and "Finished".

Step 3: Select criteria

Use this page of the **Edit Initiation Policy** dialog to select criteria to restrict which interactions are recorded. The criteria that can be selected to restrict the recording of interactions are:

- <attribute> contains the value <value>
- the listed <attributes> are not set
- interactions between <start time> and <end time>
- matches the following <day(s) of the week>
- max number of recordings are less than <number> per <period>
- randomly select <percent> of interactions per <period> per <user/system>, limiting to <max> interactions
- interactions in the selected hours
- call origin matches the following <regionalization location(s)>
- social media type <any> platform <any> channel name <any> page <any>

Note: When creating an Initiation policy for Social Media events, if there is a discrepancy between the event and the Social Media criterion, an error confirmation message is displayed when you click Apply to create the policy.

Use this step to select criteria to restrict the recording of interactions. When selecting criteria and configuring variables for Initiation policies, refer to the table [Initiation Policy Criteria Descriptions](#).

Note:

You are not required to select criteria in Step 3. If no restrictions for recording interactions are required, do not select any check boxes.

Selecting Criteria for Restricting Recordings

To select criteria that restricts the recording of interactions:

1. In the **Step 3: Select criteria** box, select the check box for the criteria to use to determine when an interaction is recorded.

In the **Policy description** pane, the criteria is added below the **and the interaction meets the following restrictions** descriptor.

2. In the **Policy description** pane, configure the criteria by clicking the variable. When you click a variable, a pop-up window is displayed to enter a value for the variable.

Note When configuring a variable, to view a table with descriptions for the Criteria values, press F1 to display the Help.

3. Continue selecting criteria check boxes and configuring them in the **Policy description** pane.

Completing Criteria Selection

When you have completed configuring the recording criteria settings, verify that the criteria you want for recording interactions are listed in the **Policy description** pane under the **and the interaction meets the following restrictions** descriptor. Also be sure that the value for each criterion is configured.

After you have verified your selections, click **Next**. The **Edit Initiation Policy** dialog, **Step4: Select actions** is displayed.

The screenshot shows the 'Edit Initiation Policy' dialog box with the following content:

- Name:** New Policy
- Step 4: Select actions**
 - record agent side only
 - record the remote side only
 - record the interaction
 - record the screen with <seconds> log time
 - record the chat transcript
 - encrypt the recording
 - send emails to <email list>
 - listen for keywords spoken by agent: <keywords>
 - listen for keywords spoken by customer: <keywords>
 - assign questionnaire to <questionnaire list>
 - set attribute on the recording
 - store interaction attribute to the recording
 - set tags to <tags>
 - abandon recording
 - stop processing more policies
- Policy description (click an underlined value to edit):**
 - This policy does not apply to anyone:**
 - If the following event(s) occur(s):**
(Any interaction)
 - and the interaction meets the following restrictions:**
(no restrictions)
 - No actions have been defined!**
- Buttons:** Cancel, < Back, Next >, Finished

Step 4: Select Actions

Use this page of the **Edit Initiation Policy** dialog to apply **Actions** to interactions. Actions define how a Policy executes. If an action is not defined for an initiation Policy, a warning message is displayed when you are creating the Policy. If no actions are defined for a Policy, an **ERROR** message is displayed in the Policy Editor status bar.

The actions that can be selected to apply to interactions are:

- record agent side only
- record the remote side only
- record the interaction
- record the screen with <seconds> lag time
- record the chat transcript
- encrypt the recording
- send emails to <email list>
- listen for keywords spoken by agent: <keywords>
- listen for keywords spoken by customer: <keywords>
- assign questionnaire to <questionnaire list>
- set attribute on the recording
- store interaction attribute to the recording
- set tags to <tags>
- abandon recording
- stop processing more policies

Selecting Actions for Interactions

Select actions to apply to interactions in the **Step 4: Select actions** box.

To select actions to apply to interactions:

1. In the **Step 4: Select actions** box, select the check box for the action to apply to an interaction.

In the **Policy description** pane, the action is added below the **perform the following actions** descriptor.

2. If a selected action requires configuring, a variable is displayed in the **Policy description** pane. To configure the value, click the variable and a pop-up window is displayed.

Note When configuring a variable, to view a table with descriptions for the Criteria values, press F1 to display the Help.

3. Continue selecting action check boxes and configuring them in the **Policy description** pane.

When selecting criteria and configuring variables for Initiation policies, refer to the table [Initiation Policy Criteria Descriptions](#).

Completing Action Selection

When you have completed configuring the action settings, verify that the actions you want for interactions are listed in the **Policy description** pane under the **perform the following actions** descriptor. Also be sure that the value for each criterion is configured.

After you have verified your selections, click **Finished**. The New Policy name is displayed in italic and selected in the **Policy** pane, and the complete description is displayed in the **Policy description** pane.

Overview

Click **Overview** to analyze the currently active Initiation policies to be sure your Initiation policies are recording and evaluating the policy entities: Users, Stations, Roles, Workgroups, and Lines. Running Overview also ensures all the users specified in your Initiation policies are licensed for Interaction Recorder access. And the Overview process warns you if your Initiation policies contain **Abandon Recording** or **Stop Processing** actions. When running this process, the Initiation Policy Overview dialog displays status information in **Overview Progress**, and presents the analysis results in the **Licensing Overview** and the **Recorded Overview** tabs. For more information, see [Initiation Policy Overview](#).

Saving a Policy

When you have completed creating a new Initiation Policy, and there are no errors, click **Apply** to save the Policy. When you click **Apply**, the Policies are saved and the italic is removed from the name in the Policy list.

Initiation Policy Criteria Descriptions

When selecting criteria and configuring variables for Initiation policies, refer to the following tables for descriptions of criteria and variable values.

Initiation Policy Step 3 Criteria Descriptions

The following table describes the details for configuring variables when setting criteria values in the **Policy description** pane. Variables are configured in a pop-up window when you click the variable below the **and the interaction meets the following restrictions** descriptor. The following criteria appear in the Policy description pane when the criterion is selected.

Criteria for Step 3: Select criteria

Criterion	Description	
<attribute> contains the value <value>	Attribute	Configure the attribute variable to select which interactions are recorded. In the Edit Attribute pop-up window, use the drop-down list to select a custom attribute to configure for this criterion.
	Value	In the Edit Value pop-up window, enter a value for the attribute selected for this criterion. The special characters comma (,) and equal sign (=) can be used when entering the value.
	To add additional attributes and values for this criterion, click [Add]. To remove an attribute and value for this criterion, click [Remove].	
the following attributes are not set <Attribs>	Attribs	Configure the Attribs variable to select which interactions are recorded when a custom attribute is not set. In the Attributes Editor pop-up window, use the Enter an attribute drop-down list to select a custom attribute, and then click Add. The attribute is added to the attribute list. To remove an attribute from the list, select the attribute in the list and click Remove.
interactions between 12:00 AM and 12:00 AM	Configure the time variables to set the start and stop times for the recording of interactions.	
	12:00 AM	In the Time Editor pop-up window, in the Time box, use the up and down arrows to set the hours and minutes to start recording.
	12:00 AM	In the Time Editor pop-up window, in the Time box, use the up and down arrows to set the hours and minutes to stop recording.
matches 0 days(s) in the week	Configure the days variable to select which days of the week interactions are recorded. In the Select days of week pop-up window, select the check boxes next to the days of the week to record interactions.	
max number of recordings is less than <count> per Hour per system	Use this criterion to restrict the number of interactions recorded during a period of time by system or agent.	
	count	In the Edit Count pop-up window, type a number for the maximum number of interactions to be recorded for this policy.
	Hour	In the Select Period pop-up window, in the Select the period box, choose the time period to record interactions for the count specified in this criterion. The available time periods are: Hour, Day, Week, Month, or Year.
	system	Use the system toggle variable to switch between recording interactions by system or agent.
randomly select 100% of interactions per hour per system, limiting to 1 interactions	Use this criterion to randomly select a number of interactions to record during a period of time by system or agent.	
	100%	In the Edit Percent pop-up window, type a number for the percent of random interactions to be recorded for this policy.

	hour	In the Select Period pop-up window, in the Select the period box, choose the time period to record interactions for the count specified in this criterion. The available time periods are: Hour, Day, Week, Month, or Year.
	system	Use the system toggle variable to switch between recording interactions by system or agent.
	1 (edit max)	In the Edit Max pop-up window, type a number for the total number of expected interactions for the time period set for this criterion.
matches 0 hour(s) in a day		Use this criterion to configure the exact hours to record interactions in a day. In the Select hours pop-up window, select the specific hours in a day to record interactions.
call origin matches regionalization locations: <locations>		Configure the locations variable to select which locations are recorded. In the Locations dialog, in the Available Locations box, select the locations, and click Add. The locations are displayed in the Selected Locations box.
social media type <any> platform <any> channel name <any> page <any>		Select the value for Social Media: type , platform , channel name , or page . For social media type , the values are: Any , Conversation , or Direct Message . For Social Media platform , the values are: Any , Facebook , or Twitter . For social media channel name , specify the social media channel configuration value or leave the field empty for any channel configuration. For social media page , specify the social media page configuration value or leave the field empty for any page configuration. Note: The social media page value is only available for Facebook, and it is limited to the standard 75 characters. If Twitter platform is selected, the page value is Not Available For more information, see the <i>Social Media Technical Reference</i> in the PureConnect Documentation Library.
(no restrictions)		This is the default setting for Step 3. If no restrictions for recording interactions are required, and you have not selected any check boxes, no restrictions is displayed under the descriptor for this step.

Initiation Policy Step 4 Action Descriptions

The following table describes the details for configuring variables when setting action values in the **Policy description** pane. Variables are configured in a pop-up window when you click the variable below the **perform the following actions** descriptor. The following actions appear in the Policy description pane when the action is selected.

Actions for Step 4: Select actions

Action	Description
record agent side only	When this action is selected, only the agent's side of the interaction is recorded.
record remote side only	When this action is selected, only the remote side of the interaction is recorded.
record the interaction	This action records both sides of the interaction.
record the agent's screen with the Default lag time	When this action is selected, the agent's screen is recorded. The default lag time is set in Interaction Recorder Screen Recording in Interaction Administrator. Use this action to set a lag time by recording. To set a lag time, click Default. On the Edit Lag Time dialog, clear the Use Default check box. Enter a Lag time value in the Lag time is field.

record the chat transcript	<p>Select this action to create a chat transcript recording.</p> <p>To create a chat transcript recording:</p> <ul style="list-style-type: none"> - First add a Web Services parameter in Interaction Administrator - Next, add a New Initiation Policy to record chat interactions <p>For more information on adding the Web Transcripts parameter, see the Interaction Web Tools Technical Reference section "Enable Chat Transcripts."</p>
encrypt the recording	<p>When this action is selected the recording is encrypted.</p> <p>Note If a call is being recorded using Proactive Recording with no encryption, the call cannot be encrypted using an Initiation Policy. When an Initiation Policy tries to encrypt a Proactive Recording, a warning is registered in the system event log. For additional information, see Enabling Recording Encryption.</p>
send emails to <email list>	<p>This action sends a notification to an email list that an interaction was recorded.</p> <p>On the Edit EMail List pop-up window, click To or CC to create an email distribution list for this action. Click Reply to specify an email address to reply to.</p> <p>Note If the Initiation Policy is set to send an email, but no recording is made for the interaction, an email is sent with a recording ID of "No Recording Produced."</p>
listen for keywords spoken by agent:<none>	<p>During a call, this action listens for keywords that are spoken by an agent. Configure this action to specify which keyword sets to use for the policy.</p> <p>When you click the variable none, the Agent Analyzer Keyword Sets dialog is displayed. From the list of Available Keyword Sets, add keyword sets to the Selected Keyword Sets list for this action. The Agent Analyzer Keyword Sets for this action are only selecting keyword sets for the Agent.</p> <p>Information about cumulative Keyword sets, keyword sets that include both Agent and Customer keywords, are displayed in the bottom pane of the dialog. This information includes: Language, Agent Keywords, Customer Keywords, Total Keyword Count, and Exceeds Keyword Count Limit. The default Total keyword counts for a policy is limited to 50 keywords per language. The total keyword count for a Language is the combination of the keyword counts from all of the Keyword Sets selected in this Agent action plus the keyword counts from the Customer action, if included in the policy.</p> <p>For information on creating Keyword Sets, see the Interaction Analyzer Technical Reference in the PureConnect Documentation Library.</p> <p>For additional information, see Important Notes for Keyword Spotting following this table.</p>
listen for keywords spoken by customer:<none>	<p>During a call, this action listens for keywords that are spoken by a customer. Configure this action to specify which keyword sets to use for the policy.</p> <p>When you click the variable none, the Agent Analyzer Keyword Sets dialog is displayed. From the list of Available Keyword Sets, add keyword sets to the Selected Keyword Sets list for this action. The Customer Analyzer Keyword Sets for this action are only selecting keyword sets for the Customer.</p> <p>Information about cumulative Keyword sets, keyword sets that include both Agent and Customer keywords, are displayed in the bottom pane of the dialog. This information includes: Language, Agent Keywords, Customer Keywords, Total Keyword Count, and Exceeds Keyword Count Limit. The default Total keyword counts for a policy is limited to 50 keywords per language. The total keyword count for a Language is the combination of the keyword counts from all of the Keyword Sets selected in this Customer action plus the keyword counts from the Agent action, if included in the policy.</p> <p>For information on creating Keyword Sets, see the Interaction Analyzer Technical Reference in the PureConnect Documentation Library.</p> <p>For additional information, see Important Notes for Keyword Spotting following this table.</p>

<p>assign questionnaire to <questionnaire list></p>	<p>This action assigns an active questionnaire to the questionnaire list associated with a recording. In the Assign Questionnaire dialog, select the questionnaire from the questionnaire list.</p> <p>To select this questionnaire for calibration, select the Mark for calibration check box.</p> <p>To require the scored user's signature for the completed questionnaire, select the Require agent signoff check box.</p> <p>Next, to assign the questionnaire to a scoring user, in the Select scoring user box, in the Search for entities field, begin typing the name of an entity: Agent, Workgroup, or Role. Entity names that match are displayed in a pop-up window. Note that the entity type icon is displayed next to the entity name. A Filter legend lists the entity types and their icons. To reduce the number of entities returned in the search results, clear the check boxes for the entities you do not want to include in the search. In the pop-up window, click the entity to apply this questionnaire to. The entity is displayed in the entity list box. Continue adding entities using the Search for entities field. These entities will be selected by round-robin. To remove an entity from the list, select an entity and click Remove.</p>						
<p>set attribute <attribute> on the recording to <value></p>	<table border="1"> <tr> <td colspan="2" data-bbox="293 575 1515 625"> <p>Configure this action to set a custom attribute for a recording.</p> </td> </tr> <tr> <td data-bbox="293 625 412 680"> <p>attribute</p> </td> <td data-bbox="417 625 1515 680"> <p>In the Edit Attribute pop-up window, type or select a name for the custom attribute.</p> </td> </tr> <tr> <td data-bbox="293 680 412 779"> <p>value</p> </td> <td data-bbox="417 680 1515 779"> <p>In the Edit Value pop-up window, enter a value for the attribute selected for this action.</p> <p>The special characters comma (,) and equal sign (=) can be used when entering the value.</p> </td> </tr> </table>	<p>Configure this action to set a custom attribute for a recording.</p>		<p>attribute</p>	<p>In the Edit Attribute pop-up window, type or select a name for the custom attribute.</p>	<p>value</p>	<p>In the Edit Value pop-up window, enter a value for the attribute selected for this action.</p> <p>The special characters comma (,) and equal sign (=) can be used when entering the value.</p>
<p>Configure this action to set a custom attribute for a recording.</p>							
<p>attribute</p>	<p>In the Edit Attribute pop-up window, type or select a name for the custom attribute.</p>						
<p>value</p>	<p>In the Edit Value pop-up window, enter a value for the attribute selected for this action.</p> <p>The special characters comma (,) and equal sign (=) can be used when entering the value.</p>						
<p>store interaction attribute <attribute> to the recording</p>	<p>Configure this action to assign a custom attribute to the recording. In the Edit Attribute pop-up window, type or select a name for the custom attribute to be stored with the recording.</p>						
<p>set tags to <Tags></p>	<p>Use this action to create tags for an interaction recording. In the Tags Editor pop-up window, type or select a tag name and click Add. All the tags created in the Tags Editor list are displayed in the Policy description pane.</p>						
<p>abandon recording</p>	<p>Select the abandon recording action to specify that certain users, workgroups, or roles should not be recorded. If an interaction matches multiple policies, and one of the policies has the abandon recording action, the interaction will not be recorded.</p>						
<p>stop processing more policies</p>	<p>Add this action to a Policy to stop processing policies that follow it. The order of a policy is set in the Policy pane, using the up and down arrows.</p>						

Important Notes for Keyword Spotting

- Initiation policies that include Analyzer Keyword Sets are combined when a call is received. For example, if Policy A has a keyword set Polite Phrases for the Agent and Policy B has a keyword set Rude Phrases for the Agent and both policies apply to a call, Agents on that call will be spotted with the keyword sets Polite Phrases and Rude Phrases. If the combination of Keyword Sets from multiple Initiation policies causes the keyword count to exceed the configured maximum keywords per language, an error is logged and no keyword spotting occurs. The default Analyzer Maximum Keyword Count server parameter default value is 50. The value for this server parameter can be changed in Interaction Administrator.
- If a keyword count configuration on a call exceeds the maximum allowed, an error is logged in one or two places: an error is logged in the *recorder server* trace logs for every call whose configuration exceeds the maximum keyword count, and a Windows Event Log error is logged once an hour. For example, if during the course of 8 hours there were 100 calls per hour that had configurations that exceeded the maximum keyword count, then at the end of those 8 hours there would be 800 errors in the *recorder server* trace logs and 8 errors logged in the Windows Event Log.
- When a policy turns keyword spotting on for a call, it remains on for the duration of the recording, even if a call is transferred. Policies can be configured to turn off keyword spotting by using the default keyword set selection **<none>**. If the Policy action value is set to **<none>** for either the Agent or the Customer *and* no other policy that applies to the call contains Keyword Sets for the Agent or Customer, then the **<none>** selection forces keyword spotting off, and no keywords are added to the combined Initiation Policies. To turn keyword spotting off when a call is transferred to a specific agent, station, role, or workgroup, set the Policy action to **<none>**.
- Intercom call keyword spotting behaves differently than keyword spotting for inbound and outbound calls. Intercom calls consist of two internal users: the user *initiating* the call and the user *receiving* the call. CIC does not support applying both users' keyword spotting policies for intercom calls. For intercom calls, CIC applies the *receiving* user's keyword spotting policies. As a result, only the keyword sets that were configured by the *receiving* user's policy actions **listen for keywords spoken by agent** and **listen for keywords spoken by customer** are used to listen for keywords spoken during intercom calls. When the *receiving* user's keyword spotting actions are applied, the *receiving* user is spotted for **agent** keywords, and the *initiating* user is spotted for **customer** keywords.
- For details on identifying recordings for evaluation based on Spotted Keywords and Phrases, see [Appendix F: Identify Recordings by Spotted Keywords and Phrases for Evaluation](#).

Initiation Policy Overview

Use **Overview** to analyze the currently active Initiation policies to be sure your Initiation policies are recording and evaluating the policy entities: Users, Stations, Roles, Workgroups, and Lines. Running Overview also ensures all the users specified in your Initiation policies are licensed for Interaction Recorder access. And the Overview process warns you if your Initiation policies contain **Abandon Recording** or **Stop Processing** actions. When running this process, the Initiation Policy Overview dialog displays status information in **Overview Progress**, and presents the analysis results in the **Licensing Overview** and the **Recorded Overview** tabs.

After you have created your Initiation Policies, clicking **Overview** displays the Initiation Policy Overview dialog.

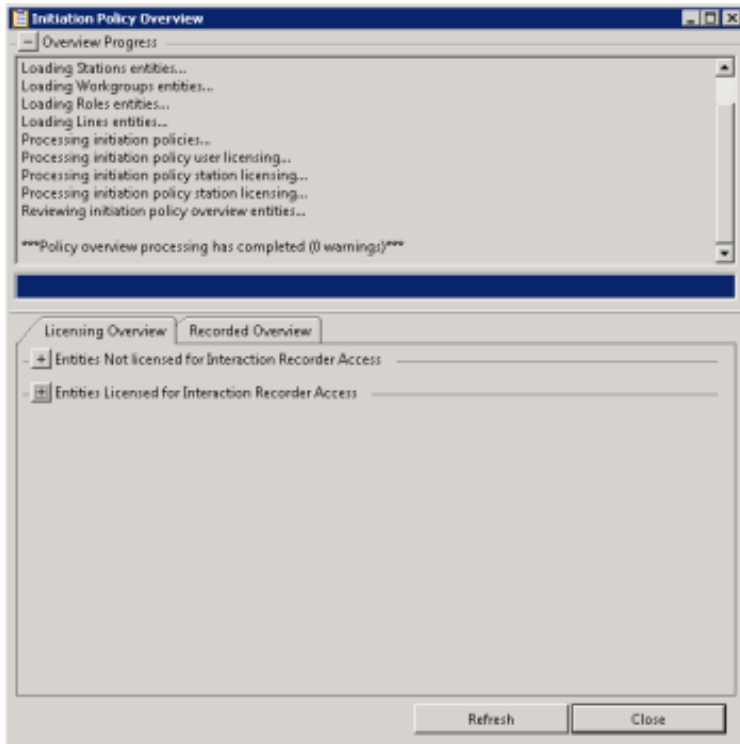

Overview Progress

The Overview Progress box is at the top of the dialog and displays each step in the policy analysis along with any warnings. Warnings are displayed if any entities are not licensed or not recorded. Warnings are also displayed if your Initiation policies contain **Abandon Recording** or **Stop Processing** actions. A warning also appears if Policy Editor is run against an older server, stating that the licensing information is unavailable. When no warnings occur, the Overview Progress box is collapsed.

Licensing Overview

The Licensing Overview tab lists every user and station by type on the server, in the **Entities Licensed for Interaction Recorder Access** box or **Entities Not Licensed for Interaction Recorder Access** box.

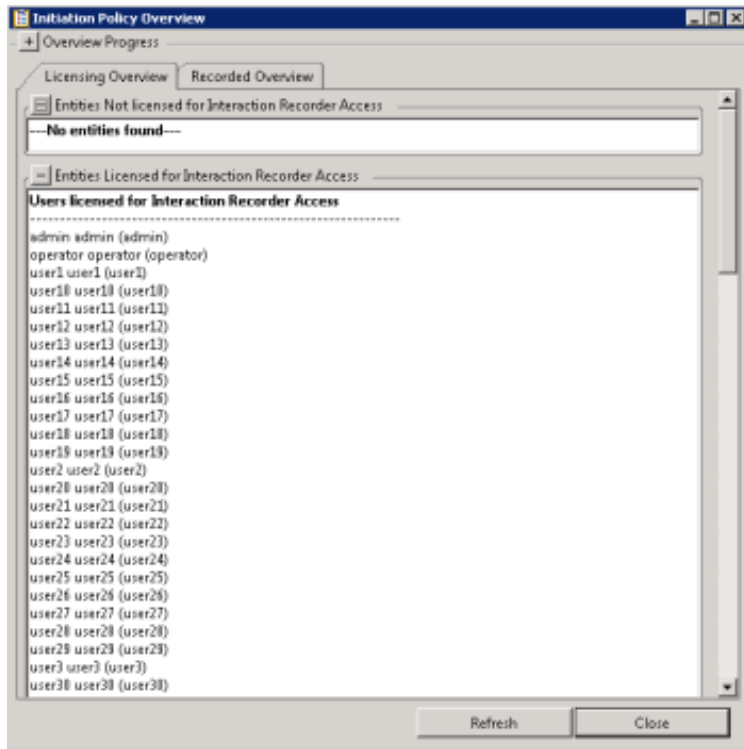

If any entities are *not* licensed, the **Entities Not Licensed for Interaction Recorder Access** box is open and the **Entities Licensed for interaction Recorder Access** box is collapsed. Otherwise, the **Entities Licensed for interaction Recorder Access** box is open and the **Entities Not Licensed for Interaction Recorder Access** box is collapsed.

Recorded Overview

The Recorded Overview tab lists all Users, Stations, Roles, Workgroups, and Lines, by type on the server, in the **Entities Recorded/Evaluated by Initiation Policies** box or **Entities Not Recorded/Evaluated by Initiation Policies** box.

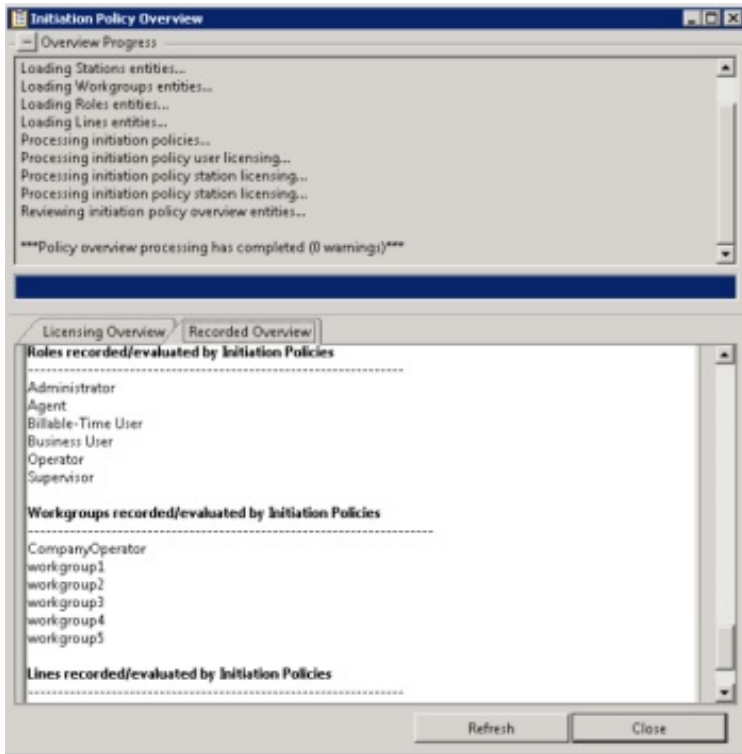

If any entities are not licensed, the **Entities Not Recorded/Evaluated by Initiation Policies** box is open and the **Entities Recorded/Evaluated by Initiation Policies** box is collapsed. Otherwise, the **Entities Recorded/Evaluated by Initiation Policies** box is open and the **Entities Not Recorded/Evaluated by Initiation Policies** box is collapsed.

Note

No criteria is analyzed when determining which entities will be recorded. All entities that are specified in an Initiation Policy containing a record action are added to the **Entities Recorded/Evaluated by Initiation Policies** box. Recording actions that are supported include: record interaction, record agent side only, and record chat transcript.

Creating a Retention Policy

Create Retention Policies to configure where recordings are stored, when they should be archived, and how long they are retained. After Retention Policies evaluate a recording, in order for the recording to be re-evaluated by the Retention Policies, be sure to create a Retention Policy with the re-evaluation action. This action allows the recording to be re-evaluated by Retention Policies.

Retention policies are created in Interaction Administrator under Interaction Recorder on the Policy Editor Configuration dialog, on the **Retention** page.

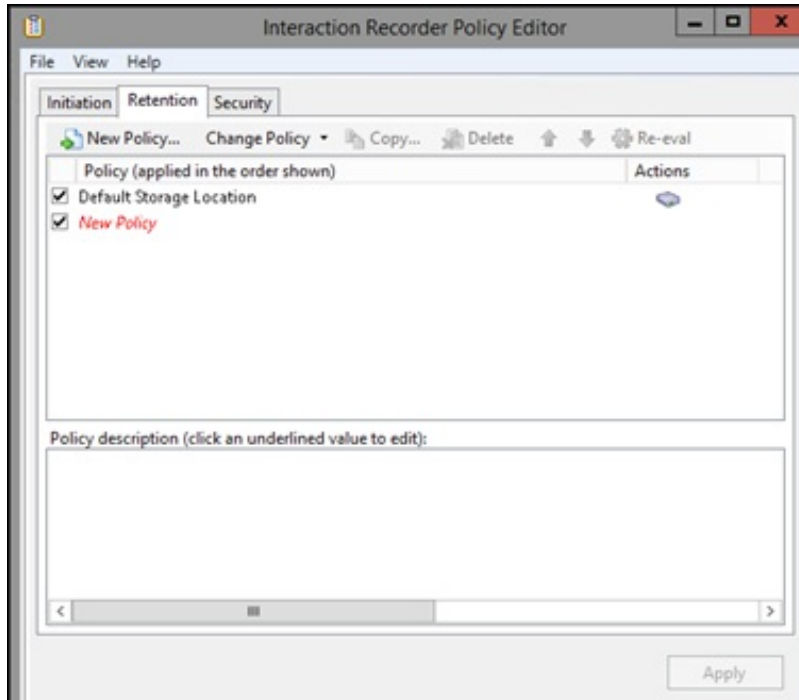

Default Storage Location Policy

If you used IC Setup Assistant to configure the **Default Storage Location**, the directory you specified is configured in the Default Storage Location policy. To change the default storage for compressed and processed recordings, edit the value for **store media** at in the Policy description pane.

Create a New Retention Policy

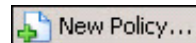

To create a new Retention Policy, on the Retention page toolbar, click **New Policy**. The **Edit Retention Policy** dialog is displayed, beginning with **Step 1**.

The dialog box is titled "Edit Retention Policy" and has a close button (X) in the top right corner. It contains a text field for the policy name, which is currently "New Policy". Below this is a section titled "Step 1: Select criteria" containing a list of 20 criteria, each with an unchecked checkbox. The criteria are: <attribute> has the value <value>; the listed <attributes> are not set; recordings between <start date> and <end date>; recording length is <more/less> than <duration>; agent matches the following <agents>; media location matches the following <media locations>; matches the following <workgroup>; media type is <Type>; Tracker participant is <participant>; tag matches the following <tags>; the listed <tags> are not set; matches the following <wrap-up code>; recordings that are <more/less> than <period> old; recording is <older/newer> than <duration> <period> old; recording has been archived: <true/false>; is a snippet recording: <true/false>; social media type <any> platform <any> channel name <any> page <any>. Below the criteria list is a section for the policy description, which currently contains the text: "This policy applies to all recordings" and "No actions have been defined". At the bottom of the dialog are four buttons: "Cancel", "< Back", "Next >", and "Finished".

Name
New Policy

Step 1: Select criteria

- <attribute> has the value <value>
- the listed <attributes> are not set
- recordings between <start date> and <end date>
- recording length is <more/less> than <duration>
- agent matches the following <agents>
- media location matches the following <media locations>
- matches the following <workgroup>
- media type is <Type>
- Tracker participant is <participant>
- tag matches the following <tags>
- the listed <tags> are not set
- matches the following <wrap-up code>
- recordings that are <more/less> than <period> old
- recording is <older/newer> than <duration> <period> old
- recording has been archived: <true/false>
- is a snippet recording: <true/false>
- social media type <any> platform <any> channel name <any> page <any>

Policy description (click an underlined value to edit):
This policy applies to all recordings
No actions have been defined

Cancel < Back Next > Finished

Step 1: Select criteria

Use this page of the **Edit Retention Policy** dialog to select retention criteria for a recorded interaction. The criteria that can be selected to retain a recorded interaction are:

- <attribute> contains the value <value>
- the listed <attributes> are not set
- recordings between <start date> and <end date>
- recording length is <more/less> than <duration>
- agent matches the following <agents>
- media location matches the following <media locations>
- matches the following <workgroup>
- media type is <Type>
- Tracker participant is <participant>
- tag matches the following <tags>
- the listed <tags> are not set
- matches the following <wrapup code>
- recordings that are <more/less> than <period> old
- recording is <older/newer> than <duration> <period> old
- recording has been archived:<true/false>
- is a snippet recording: <true/false>
- social media type <any> platform <any> channel name <any> page <any>

Note

If no criteria are selected, the policy applies to all recordings.

Selecting Criteria for Retaining Recordings

Select the retention criteria for recordings in the **Step 1: Select criteria** box.

To select retention criteria for interaction recordings:

1. In the **Name** field, type a descriptive name for the policy.
2. In the **Step 1: Select criteria** box, select the check box for the criteria to use for retention settings for recorded interactions.

In the **Policy description** pane, the criteria is added below the **if the interaction meets the following criteria** descriptor.

3. In the **Policy description** pane, configure the criteria by clicking the variable. When you click a variable, a pop-up window is displayed to enter a value for the variable.

Note When configuring a variable, to view a table with descriptions for the Criteria values, press F1 to display the Help.

4. Continue selecting criteria check boxes and configuring them in the **Policy description** pane.

When selecting criteria and configuring variables for Retention policies, refer to the [Retention Policy Criteria Descriptions](#).

Completing Criteria Selection

When you have completed configuring the retention criteria settings, verify that the criteria you want for retaining recording interactions are listed in the **Policy description** pane under the **if the interaction meets the following criteria** descriptor. Also be sure that the value for each criterion is configured.

After you have verified your selections, click **Next**. The **Edit Retention Policy** dialog, **Step2: Select actions** is displayed.

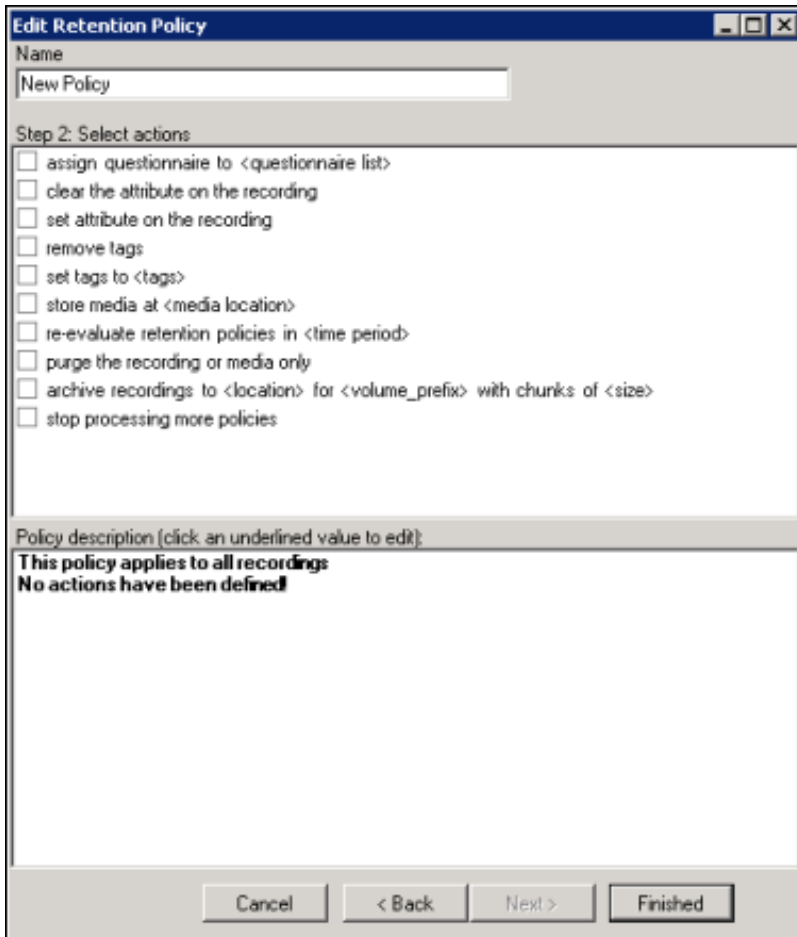

The screenshot shows the 'Edit Retention Policy' dialog box. The title bar reads 'Edit Retention Policy'. Below the title bar, there is a 'Name' field containing 'New Policy'. The main area is titled 'Step 2: Select actions' and contains a list of actions with checkboxes:

- assign questionnaire to <questionnaire list>
- clear the attribute on the recording
- set attribute on the recording
- remove tags
- set tags to <tags>
- store media at <media location>
- re-evaluate retention policies in <time period>
- purge the recording or media only
- archive recordings to <location> for <volume_prefix> with chunks of <size>
- stop processing more policies

Below the list is a 'Policy description (click an underlined value to edit):' section. It contains the text: **This policy applies to all recordings** and **No actions have been defined!**. At the bottom of the dialog are four buttons: 'Cancel', '< Back', 'Next >', and 'Finished'.

Step 2: Select actions

Use this page of the **Edit Retention Policy** dialog to apply retention **Actions** to recordings. Actions define how a Policy executes. If an action is not defined for a retention Policy, a warning message is displayed when you are creating the Policy. If no actions are defined for a Policy, an **ERROR** message is displayed in the Policy Editor status bar.

The retention actions that can be selected to apply to recordings are:

- assign questionnaire to <questionnaire list>
- clear the attribute on the recording
- set attribute on the recording
- remove tags
- set tags to <tags>
- store media at <media location>
- re-evaluate retention policies in <time period>
- purge the recording or media only
- archive recordings to <location> for <volume_prefix> with chunks of <size>
- stop processing more policies

Selecting Actions for Recordings

Select retention actions to apply to recordings in the **Step 2: Select actions** box.

To select actions to apply to recordings:

1. In the **Step 2: Select actions** box, select the check box for the retention action to apply to a recording.

In the **Policy description** pane, the action is added below the **perform the following actions** descriptor.

2. If a selected action requires configuring, a variable is displayed in the **Policy description** pane. To configure the value, click the variable and a pop-up window is displayed.

Note When configuring a variable, to view a table with descriptions for the Criteria values, press F1 to display the Help.

3. Continue selecting action check boxes and configuring them in the **Policy description** pane.

When selecting criteria and configuring variables for Retention policies, refer to the [Retention Policy Criteria Descriptions](#).

Completing Action Selection

When you have completed configuring the action settings, verify that the retention actions you want for recordings are listed in the **Policy description** pane under the **perform the following actions** descriptor. Also be sure that the value for each criterion is configured.

After you have verified your selections, click **Finished**. The New Policy name is displayed and selected in the **Policy** pane, and the complete description is displayed in the **Policy description** pane.

Saving a Policy

When you have completed creating a new Retention Policy, and there are no errors, click **Apply** to save the Policy. When you click **Apply**, the Policies are saved and the italic is removed from the name in the Policy list.

Retention Policy Criteria Descriptions

When selecting criteria and configuring variables for Retention policies, refer to the following tables for descriptions of criteria and variable values.

Retention Policy Step 1 Criteria Descriptions

The following table describes the details for configuring variables when setting retention criteria values in the **Policy description** pane. Variables are configured in a pop-up window when you click the variable below the **if the interaction meets the following criteria** descriptor. The following criteria appear in the Policy description pane when the criterion is selected.

Criteria for Step 1: Select Criteria

Criterion	Description	
<attribute> contains the value, <value>	Attribute	Configure the attribute variable to select which recordings apply to this retention policy. In the Edit Attribute pop-up window, use the drop-down list to select a custom attribute to configure for this criterion.
	Value	In the Edit Value pop-up window, enter a value for the attribute selected for this criterion. The special characters comma (,) and equal sign (=) can be used when entering the value.
	To add additional attributes and values for this criterion, click [Add]. To remove an attribute and value for this criterion, click [Remove].	
the following attributes are not set <Attribs>	Attribs	Configure the Attribs variable to select which recordings apply to this policy when a custom attribute is not set. In the Attributes Editor pop-up window, use the Enter an attribute drop-down list to select a custom attribute, and then click Add. The attribute is added to the attribute list. To remove an attribute from the list, select the attribute in the list and click Remove.

recordings between <start date> and <end date>	Configure the variables for this criterion to select which recordings, within a date range, apply to this retention policy.	
	start date	In the Date Editor pop-up window, select a start date from the drop-down calendar.
	end date	In the Date Editor pop-up window, select an end date from the drop-down calendar.
recording length is less than 0 seconds	<p>Configure this variable to apply this retention policy to recordings with a specific length.</p> <p>In the Compare Recording Length pop-up window, configure the first part of this setting. In the Recording length is drop-down list, select either less than or greater than.</p> <p>To configure the next setting for this criterion, in the seconds box, type the number of seconds or use the up and down arrows to select a number.</p>	
agent matches one of the following [Modify]	Configure this variable to select which agents to apply this retention policy to. In the Select Agents pop-up window, begin typing an agent name in the Search for agents box. Agent names that match are displayed in a pop-up window. When you select an agent in the pop-up, it is added to the agent list.	
media location matches the following <media locations>	Configure this variable to apply this retention policy to recordings that are located in a specific folder. In the Select Folder pop-up window, select a folder from the drop-down list. You can also browse for a folder using the ellipsis button.	
matches following <workgroup>	Configure the <workgroup> variable to select which workgroups to apply this retention policy to. In the Select Workgroups pop-up window, begin typing a workgroup name in the Search for workgroups box. Workgroup names that match are displayed in a pop-up window. When you select a workgroup in the pop-up, it is added to the workgroup list.	
media type is <media type>	Configure this variable to apply this retention policy to recordings with specific media types. In the Select Media type pop-up window, select the media type. Multiple media types can be selected. The available media types are: Call, Chat, Chat Transcript, Email, Screen, Social Conversation, and Social Direct Message.	
matches one of the following Tracker participants [Modify]	Configure this variable to select which Tracker participants to apply this retention policy to. In the Select Remote Parties pop-up window. A Filter legend lists the remote party types and their icons. To reduce the number of entities returned in the search results, clear the check boxes for the entities you do not want to include in the search. Begin typing a name in the Search for remote parties box. Names that match are displayed in a pop-up window. Note that the remote party type icon is displayed next to the remote party name. When you select a remote party in the pop-up, it is added to the remote parties list.	
tag matches the following <Tags>	Configure the <Tags> variable to select Tags, which are associated with recordings that you want to apply this retention policy to. In the Tags Editor pop-up window, in the Enter a tag box, type or select a tag name, and click Add to include the name in the Tags Editor list. All the tags created in the Tags Editor list are displayed in the Policy description pane.	
the following tags are not set <Tags>	Configure this variable to apply this retention policy to recordings that do not have these tags associated with them. In the Tags Editor pop-up window, in the Enter a tag box, type or select a tag name, and click Add to include the name in the Tags Editor list. All the tags created in the Tags Editor list are displayed in the Policy description pane.	
wrapup code is <wrapup codes>	<p>Configure the variable for this criterion to select which wrap-up codes apply to this retention policy.</p> <p>In the Select Wrapup Codes pop-up window, select the wrap-up codes to apply to this retention policy.</p>	
recordings that are older than today	<p>Configure the variable for this criterion to select which recordings, within a date range, apply to this retention policy.</p> <p>To configure the first field in the Select Date Range pop-up window, in the drop-down list, select either older than or within.</p> <p>To configure the second field in the Select Date Range pop-up window, in the drop-down list, select the period of time. The available options are: today, this week, this month, this quarter, this year.</p>	

recording is older than 0 day old	Configure the variables for this criterion to select which recordings are within or older than the specified period of time. In the Compare Recording Age first drop-down list, select older than or within. In the next box, type a number for the period of time. In the last drop-down list, select the period of time. The options are: Hour, Day, Week, Month, or Year.
recording has been archived: false	Configure the variable for this criterion to select which recordings have or have not been archived. Click the variable and toggle to true or false.
is a snippet recording: false	Configure the variable for this criterion to apply this retention policy for snippet recordings. To apply the policy to snippet recordings, click the variable and toggle to true.
social media type <any> platform <any> channel name <any> page <any>	Select the value for Social Media: type , platform , channel name , or page . For social media type , the values are: Any , Conversation , or Direct Message . For Social Media platform , the values are: Any , Facebook , or Twitter . For social media channel name , specify the social media channel configuration value or leave the field empty for any channel configuration. For social media page , specify the social media page configuration value or leave the field empty for any page configuration. Note: The social media page value is only available for Facebook, and it is limited to the standard 75 characters. If Twitter platform is selected, the page value is Not Available. For more information, see the <i>Social Media Technical Reference</i> in the PureConnect Documentation Library.

Retention Policy Step 2 Action Descriptions

The following table describes the details for configuring variables when setting retention action values in the **Policy description** pane. Variables are configured in a pop-up window when you click the variable below the **perform the following actions** descriptor. The following actions appear in the Policy description pane when the action is selected.

Action for Step 2: Select actions

Action	Description
assign questionnaire to <questionnaire list>	<p>This action assigns an active questionnaire to the questionnaire list associated with a recording. In the Assign Questionnaire dialog, select the questionnaire from the questionnaire list.</p> <p>To select this questionnaire for calibration, select the Mark for calibration check box.</p> <p>To require the scored user's signature for the completed questionnaire, select the Require agent signoff check box.</p> <p>Next, to assign the questionnaire to a scoring user, in the Select scoring user box, in the Search for entities field, begin typing the name of an entity: Agent, Workgroup, or Role. Entity names that match are displayed in a pop-up window. Note that the entity type icon is displayed next to the entity name. A Filter legend lists the entity types and their icons. To reduce the number of entities returned in the search results, clear the check boxes for the entities you do not want to include in the search. In the pop-up window, click the entity to apply this questionnaire to. The entity is displayed in the entity list box. Continue adding entities using the Search for entities field. These entities will be selected by round-robin. To remove an entity from the list, select an entity and click Remove.</p> <p>Note When assigning a Role, the maximum number of Roles that can be configured for a Retention policy is 300.</p>
clear attribute <attribute> on the recording	Configure this action to remove a custom attribute from recordings. In the Edit Attribute type or select a name of the custom attribute to be removed from recordings. To add an additional criterion to clear an attribute from a recording, click [Add]. To remove the criteria list, click [Remove].

set attribute <attribute> on the recording to <value>	Configure this action to set a custom attribute for a recording.	
	attribute	In the Edit Attribute pop-up window, type or select a name for the custom attribute.
	value	In the Edit Value pop-up window, enter a value for the attribute selected for this action. The special characters comma (,) and equal sign (=) can be used when entering the value.
remove the following tags <tags>	Use this action to remove tags from an interaction recording. In the Tags Editor pop-up window, type or select a name for the tag to be removed, and click Add. The name of the tag to be removed from recordings is added to the list. This is a list of tags that will be removed from recordings for this policy.	
set tags to <Tags>	Use this action to create tags for an interaction recording. In the Tags Editor pop-up window, type or select a tag name and click Add. All the tags created in the Tags Editor list are displayed in the Policy description pane.	
store media at <media location>	<p>Configure this variable to store a recording in a specific folder, or to select an Amazon S3 location to store your recording. In order to view a screen recording in the playback window, the action Store Media at executes before the action Archive Recording to when both actions are in the same Retention Policy.</p> <p>Note All Amazon S3 communication uses HTTPS or HTTP protocol, which is configured in Interaction Administrator, in the Interaction Recorder Configuration dialog on the Cloud Services Configuration page using the Enable HTTPS exchanges check box. By default, HTTPS is selected. Also note, the S3 Bucket name cannot contain periods as Amazon's SSL wildcard certificate only matches buckets that do not contain periods.</p> <p>Select a Folder</p> <p>To select a specific folder to store the recording, click the media location variable, and in the Select Folder pop-up window select a folder from the drop-down list. You can also browse for a folder using the ellipsis button.</p> <p>Notes</p> <ul style="list-style-type: none"> - We highly recommend that the stored recordings media location be a valid UNC path. This is necessary because there might be multiple CIC servers and Interaction Recorder servers requesting recording files from one another. To set the <media location> variable to a valid UNC path, on the Select Folder pop-up window, type a UNC path. - If a Retention policy includes both the "store media at" action and the "purge the media only" action, the "store media at" action is not executed. <p>Amazon S3 location</p> <p>To store a recording using Amazon Simple Storage Service (Amazon S3), select the check box Amazon S3 location.</p> <p>Next, select a Bucket from the drop-down list and in the Subfolder field type a name for the subfolder where the recordings will be stored.</p> <p>Configure Amazon S3 Bucket</p> <ul style="list-style-type: none"> - Configure in Interaction Administrator Amazon S3 location Buckets are configured in Interaction Administrator and are available in the Bucket list. For more information see Cloud Services Configuration. - Configure in Policy Editor <p>You can also configure a new Amazon S3 Bucket in Policy Editor from the Bucket drop-down list. To do this:</p> <ul style="list-style-type: none"> -Select <Configure> and on the S3 Bucket Configuration dialog, add the Amazon Account ID and Secret Key information for the new Bucket. -In the Region Endpoint list, select the region where recordings are stored or accessed. -If the Region Endpoint is not in the list, you can select Specify Custom S3 Endpoint and click Configure. In the Specify Custom Endpoint dialog, enter the endpoint information. When adding a custom region and endpoint, the display name must match the region name defined for the given endpoint. Endpoints are defined in Amazon S3. <p>The endpoint information helps reduce data latency when you access or store recordings with the Amazon S3 service.</p> <p>Click Test to validate the proper access level for the specified account credentials.</p> <p>For information on Amazon Simple Storage Service, see Amazon Web Services at http://aws.amazon.com/s3.</p>	

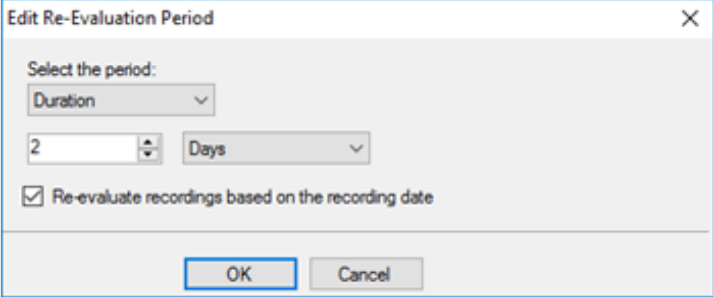
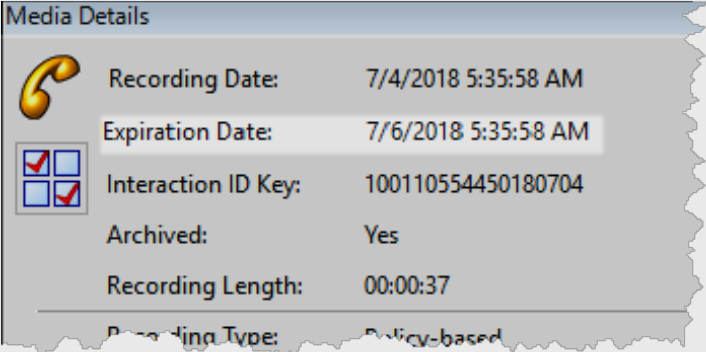
<p>re-evaluate retention policies in Never</p>	<p>Configure this variable to set the time period for a recording to be re-evaluated. Recordings can be re-evaluated based on the last time a recording was evaluated by a policy, or based on the recording date.</p> <p>In the Edit Re-Evaluation Period dialog box, select the time period from the drop-down list. The available re-evaluation time periods are: Never or Duration.</p> <p>The default time period is Never, which means the recording will never be re-evaluated by the policy. You can modify the retention expiration date manually in Interaction Recorder Client, in the Search Results View. For more information, see Modify Retention Expiration.</p> <p>When you select Duration, values are displayed. You can set the re-evaluation duration by Minutes, Hours, Days, Weeks, Months, Quarters, or Years, to re-evaluate the recordings based on the last time a recording was evaluated by a policy.</p> <p>Note: A month is defined as 31 days, a quarter is defined as 93 days, and one year is defined as 365 days.</p> <p>To re-evaluate the recordings based on the recording date, select the Re-evaluate recordings based on the recording date check box. The Duration value is added to the recording date. For example, if you select 2 Days, the recordings will be re-evaluated two days after the recording was created.</p>  <p>Note: If the server parameter, IR Use Recording Date for Expired Calculations, has been set True in Interaction Administrator, the Re-evaluate recordings based on the recording date check box is not available. For more information on this server parameter, see Appendix C: Interaction Recorder Server Parameters.</p> <p>You can view the retention expiration date of a recording in the Media Details pane in Interaction Recorder Client in IC Business Manager.</p>  <p>After Retention Policies evaluate a recording, in order for the recording to be re-evaluated by the Retention Policies, be sure to create a Retention Policy with the re-evaluation action. This action allows the recording to be re-evaluated by Retention Policies.</p> <p>Note: When a recording matches multiple Retention Policies, the policy with the shortest re-evaluation time interval is used to re-evaluate the recording. For example if a recording matches three retention policies, one with a 3-day re-evaluation interval, another with a 30-day re-evaluation interval, and another policy matches with a 1-year re-evaluation interval, the recording will be re-evaluated in 3 days.</p>
<p>purge the recording and media</p>	<p>Configure this variable to purge a recording and media for a recording, or to only purge the media for a recording. Media refers to the actual audio or video recording, and recording and media refers to the audio or video recording and the database records. If you purge the media only, the database records remain for reporting purposes.</p> <p>To purge the audio or video and the database records, click the variable and toggle to recording and media.</p> <p>To purge only the audio or video recording, click the variable and toggle to media only.</p>

<p>archive recording to <media location> for <volume prefix> with chunks of 0 MB</p>	<p>Configure these variables to archive recordings to a specific volume folder, or to select an Amazon S3 location to archive a recording. In order to view a screen recording in the playback window, the action Store Media at executes before the action Archive Recording to when both actions are in the same Retention Policy.</p> <p>Note: For information on automatically archiving recordings using Interaction Recorder Policy Editor, see "Appendix D: Archive Recordings" in the Interaction Recorder Technical Reference in your PureConnect Documentation Library.</p> <p>Note: All Amazon S3 communication uses HTTPS or HTTP protocol, which is configured in Interaction Administrator, in the Interaction Recorder Configuration dialog on the Cloud Services Configuration page using the Enable HTTPS exchanges check box. By default, HTTPS is selected.</p> <p>Select a Folder</p> <p>To select a specific folder to archive a recording, click the media location variable and in the Archive storage location pop-up window, specify a valid non-local shared UNC path.</p> <p>Click the volume prefix variable, and in the Archive volume prefix pop-up window, specify a prefix string for the archive volume name.</p> <p>Click the 0 MB variable, and in the Edit Storage size pop-up window, type the maximum storage size for each archive volume folder. Click the MB box to toggle between MB and GB.</p> <p>Note: When entering the storage size for an archive volume folder in an Archive action, the Edit Storage size dialog shows a red error rectangle around the storage size field and the OK button is not available, if the field is empty or 0 is specified. The Edit Storage Size dialog shows a yellow warning rectangle around the storage size field when the storage size is determined to be risky and outside of the normal storage range. A tooltip is displayed explaining the error or warning.</p> <p>Amazon S3 location</p> <p>To archive a recording using amazon Simple Storage Service (Amazon S3), click the media location variable, and in the Archive storage location pop-up window select the check box Amazon S3 location.</p> <p>Next, select a Bucket from the drop-down list and in the Subfolder field type a name for the subfolder where the recordings will be archived.</p> <p>Click the volume prefix variable, and in the Archive volume prefix pop-up window, specify a prefix string for the archive volume name.</p> <p>Click the 0 MB variable, and in the Edit Storage size pop-up window, type the maximum storage size for each archive volume folder. Click the MB box to toggle between MB and GB.</p> <p>Configure Amazon S3 Bucket</p> <p>- Configure in Interaction Administrator</p> <p>Amazon S3 location Buckets are configured in Interaction Administrator and are available in the Bucket list. For more information see Cloud Services Configuration.</p> <p>- Configure in Policy Editor</p> <p>You can also configure a new Amazon S3 Bucket in Policy Editor from the Bucket drop-down list. To do this:</p> <ul style="list-style-type: none"> -Select <Configure> and on the S3 Bucket Configuration dialog, add the Amazon Account ID and Secret Key information for the new Bucket. -In the Region Endpoint list, select the region where recordings are stored or accessed. -If the Region Endpoint is not in the list, you can select Specify Custom S3 Endpoint and click Configure. In the Specify Custom Endpoint dialog, enter the endpoint information. When adding a custom region and endpoint, the display name must match the region name defined for the given endpoint. Endpoints are defined in Amazon S3. <p>The endpoint information helps reduce data latency when you access or store recordings with the Amazon S3 service.</p> <p>Click Test to validate the proper access level for the specified account credentials.</p> <p>For information on Amazon Simple Storage Service, see Amazon Web Services at http://aws.amazon.com/s3.</p>
<p>stop processing more policies</p>	<p>Add this action to a Policy to stop processing policies that follow it. The order of a policy is set in the Policy pane, using the up and down arrows.</p>

Note

For more information on the archive process, see Appendix D: Archive Recordings and [Appendix E: Archive Log Resource Templates](#).

Creating a Security Policy

A Security Policy tells Interaction Recorder *Who* can access, play, score, export, and archive recordings. Create a Security Policy to specify which actions specific users are allowed to perform on selected recordings. Security policies apply to Agents and Roles. Security policies are created in Interaction Administrator under Interaction Recorder on the Policy Editor Configuration dialog, on the Security page.

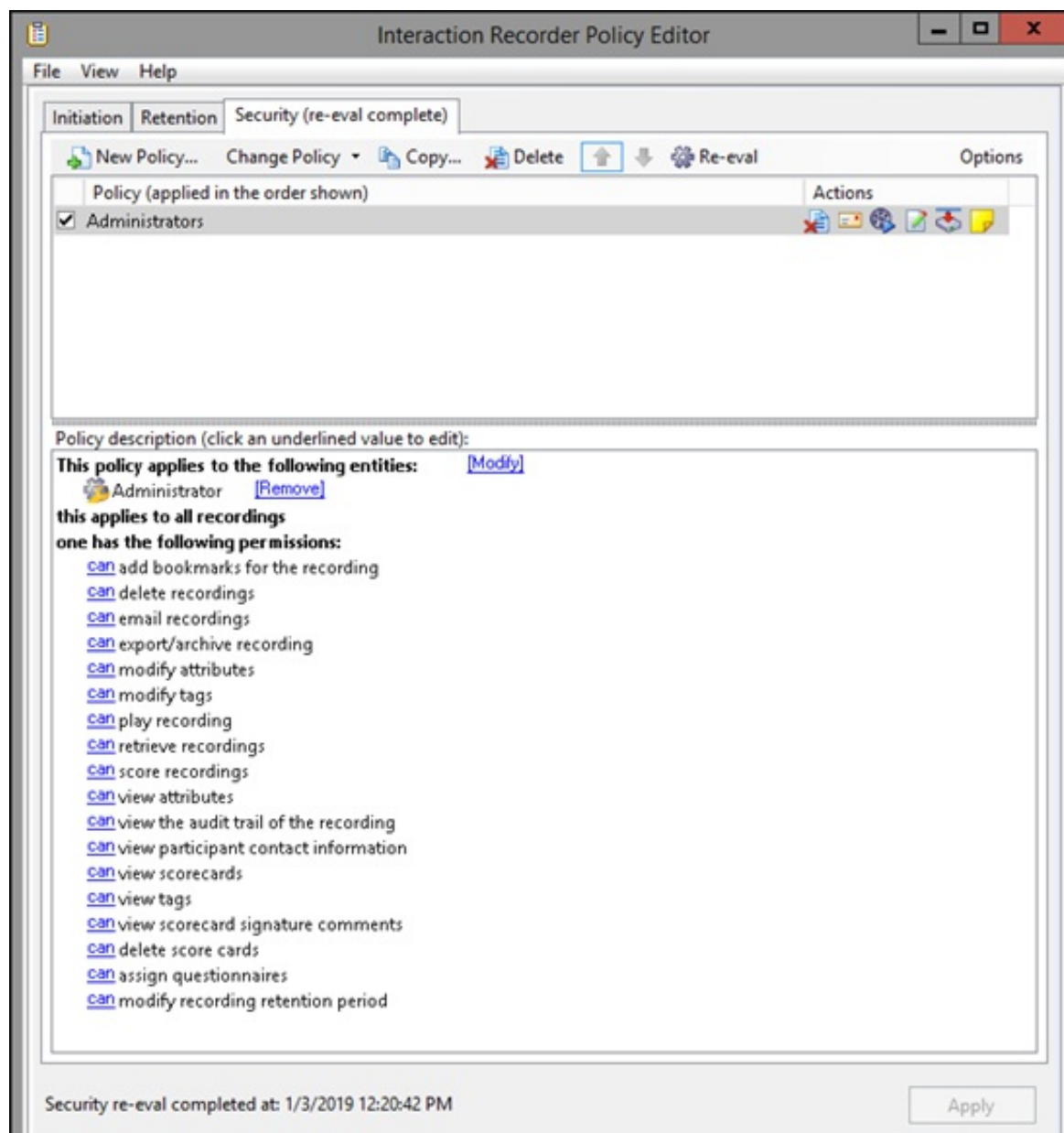

Administrators Security Policy

An Administrators security policy is provided, giving all Security permissions to users who are assigned the Administrator Role.

Create a New Security Policy

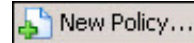

To create a new Security Policy, on the Security page toolbar, click **New Policy**. The **Edit Security Policy** dialog is displayed, beginning with **Step 1**.

The screenshot shows the "Edit Security Policy" dialog box. At the top, the title bar reads "Edit Security Policy". Below it, the "Name" field contains "New Policy". The main section is titled "Step 1: Applies to the following entities". It features a "Search for entities:" text box on the left and a "Legend" box on the right containing "Agent" and "Role" with person icons. A "Remove" button is located below the legend. At the bottom left of this section is a checkbox labeled "Applies to all entities", which is currently unchecked. Below this is the "Policy description (click on underlined value to edit):" section, which contains the text: "This policy does not apply to anyone.", "this applies to all recordings", and "No permissions have been defined!". At the very bottom of the dialog are four buttons: "Cancel", "< Back", "Next >", and "Finished".

Step 1: Applies to the following entities

Use this page of the **Edit Security Policy** dialog to apply the policy to entities. You can assign the following entities:

- Agent
- Role

Applying Policies to Entities

You can apply this policy to all available entities *or* you can select specific entities to apply the policy to.

Apply policy to all entities

To apply this policy to all entities:

1. In the **Name** field, type a descriptive name for the policy.
2. In the **Step 1: Applies to the following entities** box, the **Filter** legend lists the entity types and their icons. To apply this policy to all entities, select the **Applies to all entities** check box.

In the **Policy description** pane, the entity description, **This policy applies to everyone** is displayed.

Apply policy to specific entities

To apply this policy to specific entities:

1. In the **Name** field, type a descriptive name for the policy.
2. Be sure the **Applies to all entities** check box is clear.
3. In the **Step 1: Applies to the following entities** box, the **Filter** legend lists the entity types and their icons. To reduce the number of entities returned in the search results, clear the check boxes for the entities you do not want to include in the search. For example, if you know the entity you are searching is a Role, clear the other check boxes.
4. To apply this policy to specific entities, click in the **Search for entities** field.
5. In the **Search for entities** field, begin typing an entity name, for example the name of an **Agent** or **Role**. Entity names that match are displayed in a pop-up window. Note that the entity type icon is displayed next to the entity name.
6. In the pop-up window, click the entity to apply this policy to. The entity is displayed in the entity list box.

In the **Policy description** pane, the entity is added below the **This policy applies to the following entities** descriptor.

7. Continue adding entities using the **Search for entities** field.

Removing Entities from a Policy

To remove an entity from this policy, from the entity list box, select an entity and click **Remove**. The entity is removed from the list box and also removed from the policy descriptor **This policy applies to the following entities** in the **Policy description** pane.

Completing applying entities

The Policy description pane is updated as Security Policy settings are added and updated.

When the Policy description for applying Security Policies to entities is complete, click **Next**. The **Edit Security Policy** dialog, **Step 2: Select criteria** is displayed.

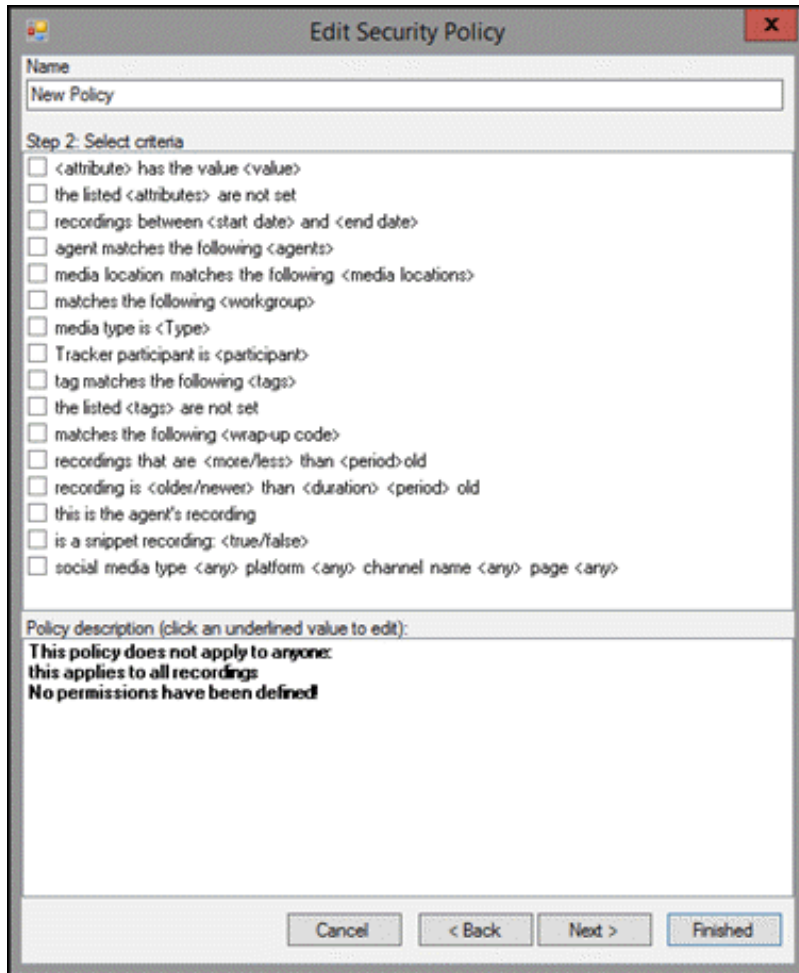

The screenshot shows a dialog box titled "Edit Security Policy" with a close button (X) in the top right corner. The dialog is divided into several sections:

- Name:** A text field containing "New Policy".
- Step 2: Select criteria:** A list of 18 criteria, each with an unchecked checkbox:
 - <attribute> has the value <value>
 - the listed <attributes> are not set
 - recordings: between <start date> and <end date>
 - agent matches the following <agents>
 - media location matches the following <media locations>
 - matches the following <workgroup>
 - media type is <Ttype>
 - Tracker participant is <participant>
 - tag matches the following <tags>
 - the listed <tags> are not set
 - matches the following <wrap-up code>
 - recordings that are <more/less> than <period> old
 - recording is <older/newer> than <duration> <period> old
 - this is the agent's recording
 - is a snippet recording: <true/false>
 - social media type <any> platform <any> channel name <any> page <any>
- Policy description (click an underlined value to edit):** A text area containing the following text:

This policy does not apply to anyone:
this applies to all recordings:
No permissions have been defined
- Buttons:** At the bottom, there are four buttons: "Cancel", "< Back", "Next >", and "Finished".

Step 2: Select criteria

Use this page of the Edit **Security Policy** dialog to select criteria for applying this security policy to specific recordings.

The criteria that can be selected to apply this policy to recordings are:

- <attribute> contains the value <value>
- the listed <attributes> are not set
- recordings between <start date> and <end date>
- agent matches the following <agents>
- media location matches the following <media locations>
- matches the following <workgroup>
- media type is <Type>
- Tracker participant is <participant>
- tag matches the following <tags>
- the listed <tags> are not set
- matches the following <wrapup code>
- recordings that are <more/less> than <period> old
- recording is <older/newer> than <duration> <period> old
- this is the agent's recording
- is a snippet recording:<true/false>
- social media type <any> platform <any> channel name <any> page <any>

Note

If no criteria are selected, the policy applies to all recordings.

Selecting Criteria for Recordings

Select the criteria for recordings, for this security policy, in the **Step 2: Select criteria** box.

To select criteria for interaction recordings:

1. In the **Step 2: Select criteria** box, select the check box for the criteria to use for applying security settings to recorded interactions.

In the **Policy description** pane, the criteria is added below the **if the interaction meets the following criteria** descriptor.

2. In the **Policy description** pane, configure the criteria by clicking the variable. When you click a variable, a pop-up window is displayed to enter a value for the variable.

Note When configuring a variable, to view a table with descriptions for the Criteria values, press F1 to display the Help.

3. Continue selecting criteria check boxes and configuring them in the **Policy description** pane.

When selecting criteria and configuring variables for Security policies, refer to the [Security Policy Criteria Descriptions](#).

Completing Criteria Selection

When you have completed configuring the criteria settings, verify that the criteria you want for applying security settings to recorded interactions are listed in the **Policy description** pane under the **if the interaction meets the following criteria** descriptor. Also be sure that the value for each criterion is configured.

After you have verified your selections, click **Next**. The **Edit Security Policy** dialog, **Step3: Select actions** is displayed.

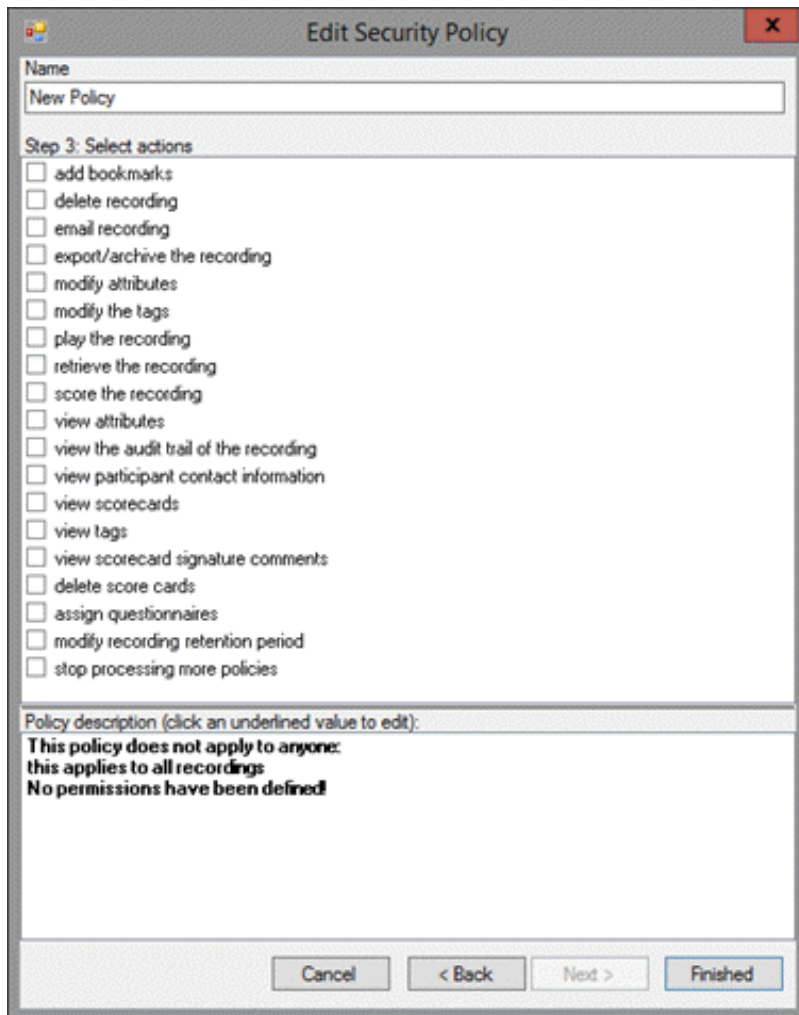

The screenshot shows a dialog box titled "Edit Security Policy" with a close button (X) in the top right corner. The dialog is divided into several sections:

- Name:** A text box containing "New Policy".
- Step 3: Select actions:** A list of 20 actions, each with an unchecked checkbox:
 - add bookmarks
 - delete recording
 - email recording
 - export/archive the recording
 - modify attributes
 - modify the tags
 - play the recording
 - retrieve the recording
 - score the recording
 - view attributes
 - view the audit trail of the recording
 - view participant contact information
 - view scorecards
 - view tags
 - view scorecard signature comments
 - delete score cards
 - assign questionnaires
 - modify recording retention period
 - stop processing more policies
- Policy description (click an underlined value to edit):** A text area containing the following text:

This policy does not apply to anyone:
this applies to all recordings
No permissions have been defined
- Buttons:** At the bottom, there are four buttons: "Cancel", "< Back", "Next >", and "Finished".

Step 3: Select actions

Use this page of the **Edit Security Policy** dialog to select **Actions** for user security permissions for this policy. Actions define how a Policy executes. If an action is not defined for a security Policy, a warning message is displayed when you are creating the Policy. If no actions are defined for a Policy, an **ERROR** message is displayed in the Policy Editor status bar.

Available actions for this Security Policy are:

- add bookmarks
- delete recording
- email recording
- export/archive the recording
- modify attributes
- modify the tags
- play the recording
- retrieve the recording
- score the recording
- view attributes
- view the audit trail of the recording
- view participant contact information
- view scorecards
- view tags
- view scorecard signature comments
- delete scorecards
- assign questionnaires
- modify recording retention period
- stop processing more policies

Selecting Actions for a Security Policy

Select actions for security permissions to apply to recordings in the **Step 2: Select actions** box.

To select actions to apply to recordings:

1. In the **Step 3: Select actions** box, select the check box for the actions for the security permissions to apply to a recording.

In the **Policy description** pane, the action is added below the **one has the following permissions** descriptor.

2. If a selected action requires configuring, a variable is displayed in the **Policy description** pane. To configure the value, click the variable and a pop-up window is displayed.

Note When configuring a variable, to view a table with descriptions for the Criteria values, press F1 to display the Help.

3. Continue selecting action check boxes and configuring them in the **Policy description** pane.

When selecting criteria and configuring variables for Security policies, refer to the [Security Policy Criteria Descriptions](#).

Completing Action Selection

When you have completed configuring the action settings, verify that the actions for security permissions you want for recordings are listed in the **Policy description** pane under the **one has the following permissions** descriptor. Also be sure that the value for each criterion is configured.

After you have verified your selections, click **Finished**. The New Policy name is displayed and selected in the **Policy** pane, and the complete description is displayed in the **Policy description** pane.

Saving a Policy

When you have completed creating a new Security Policy, and there are no errors, click **Apply** to save the Policy. When you click **Apply**, the Policies are saved and the italic is removed from the name in the Policy list. The changes take effect immediately when the Security Policy is applied.

Security Policy Criteria Descriptions

When selecting criteria and configuring variables for Security policies, refer to the following tables for descriptions of criteria and variable values.

Security Policy Step 2 Criteria Descriptions

The following table describes the details for configuring variables when setting criteria values in the **Policy description** pane. Variables are configured in a pop-up window when you click the variable below the **if the interaction meets the following criteria** descriptor. The following criteria appear in the Policy description pane when the criterion is selected.

Criteria for Step 2: Select Criteria

Criterion	Description	
<attribute> contains the value, <value>	Attribute	Configure the attribute variable to select which recordings apply to this security policy. In the Edit Attribute pop-up window, use the drop-down list to select a custom attribute to configure for this criterion.
	Value	In the Edit Value pop-up window, enter a value for the attribute selected for this criterion. The special characters comma (,) and equal sign (=) can be used when entering the value.
	To add additional attributes and values for this criterion, click [Add]. To remove an attribute and value for this criterion, click [Remove].	
the following attributes are not set <Attribs>	Attribs	Configure the Attribs variable to select which recordings apply to this policy when a custom attribute is not set. In the Attributes Editor pop-up window, use the Enter an attribute drop-down list to select a custom attribute, and then click Add. The attribute is added to the attribute list. To remove an attribute from the list, select the attribute in the list and click Remove.
recordings between <start date> and <end date>	Configure the variables for this criterion to select which recordings, within a date range, apply to this security policy.	
	start date	In the Date Editor pop-up window, select a start date from the drop-down calendar.
	end date	In the Date Editor pop-up window, select an end date from the drop-down calendar.
agent matches one of the following [Modify]	Configure this variable to select which agents' recordings to apply this security policy to. In the Select Entities pop-up window, begin typing an agent name in the Search for agents box. Agent names that match are displayed in a pop-up window. When you select an agent in the pop-up, it is added to the agent list.	
media location matches the following <media locations>	Configure this variable to apply this security policy to recordings that are located in a specific folder. In the Select Folder pop-up window, select a folder from the drop-down list. You can also browse for a folder using the ellipsis button.	
matches following <workgroup>	Configure the <workgroup> variable to select which workgroups' recordings to apply this security policy to. In the Select Entities pop-up window, begin typing a workgroup name in the Search for workgroups box. Workgroup names that match are displayed in a pop-up window. When you select a workgroup in the pop-up, it is added to the workgroup list.	
media type is <media type>	Configure this variable to apply this security policy to recordings with specific media types. In the Select Media type pop-up window, select the media type. Multiple media types can be selected. The available media types are: Call, Chat, Chat Transcript, Email, Screen, Social Conversation, and Social Direct Message.	

matches one of the following Tracker participants [Modify]	<p>Configure this variable to select which Tracker participants' recordings to apply this security policy to. In the Select Entities pop-up window. A Filter legend lists the remote party types and their icons. To reduce the number of entities returned in the search results, clear the check boxes for the entities you do not want to include in the search.</p> <p>Begin typing a name in the Search for remote parties box. Names that match are displayed in a pop-up window. Note that the remote party type icon is displayed next to the remote party name. When you select a remote party in the pop-up, it is added to the remote parties list.</p>	
tag matches the following <Tags>	Tags	Configure the <Tags> variable to select Tags, which are associated with recordings, that you want to apply this security policy to. In the Tags Editor pop-up window, in the Enter a tag box, type or select a tag name, and click Add to include the name in the Tags Editor list. All the tags created in the Tags Editor list are displayed in the Policy description pane.
the following tags are not set <Tags>	Tags	Configure this variable to apply this security policy to recordings that do not have these tags associated with them. In the Tags Editor pop-up window, in the Enter a tag box, type or select a tag name, and click Add to include the name in the Tags Editor list. All the tags created in the Tags Editor list are displayed in the Policy description pane.
recordings that are older than today	Configure the variable for this criterion to select which recordings, within a date range, apply to this security policy.	
	older than	To configure the first part of this setting, in the Select Date Range pop-up window, in the drop-down list, select either older than or within.
	today	To configure the second part of this setting, in the drop-down list select period of time. The available options are: today, this week, this month, this quarter, this year.
wrapup code is <wrapup codes>	Configure the variable for this criterion to select which wrap-up codes apply to this security policy. In the Select Wrapup Codes pop-up window, select the wrap-up codes to apply to this security policy.	
Recording is older than 0 day old	Configure the variables for this criterion to select which recordings are within or older than the specified period of time. In the Compare Recording Age first drop-down list, select older than or within. In the next box, type a number for the period of time. In the last drop-down list, select the period of time. The options are: Hour, Day, Week, Month, or Year.	
this is the agent's recording	Select this check box if you want to control which actions an agent can perform on his or her own recordings.	
is a snippet recording: false	Configure the variable for this criterion to apply this security policy for snippet recordings. To apply the policy to snippet recordings, click the variable and toggle to true.	
social media type <any> platform <any> channel name <any> page <any>	<p>Select the value for Social Media: type, platform, channel name, or page.</p> <p>For social media type, the values are: Any, Conversation, or Direct Message.</p> <p>For Social Media platform, the values are: Any, Facebook, or Twitter.</p> <p>For social media channel name, specify the social media channel configuration value or leave the field empty for any channel configuration.</p> <p>For social media page, specify the social media page configuration value or leave the field empty for any page configuration.</p> <p>Note: The social media page value is only available for Facebook, and it is limited to the standard 75 characters.</p> <p>If Twitter platform is selected, the page value is Not Available.</p> <p>For more information, see the <i>Social Media Technical Reference</i> in the PureConnect Documentation Library.</p>	

Security Policy Step 3 Action Descriptions

The following table describes the details for configuring variables when setting action values in the **Policy description** pane. Variables are configured in a pop-up window when you click the variable below the **one has the following permissions** descriptor. The following actions appear in the Policy description pane when the action is selected.

Action for Step 3: Select actions

Action	Description
can add bookmarks for the recording	Configure this action to allow specific users to add bookmarks to a recording. Use the can toggle variable to allow or deny users permission to add bookmarks to a recording by selecting can or can NOT.
can delete recordings	Configure this action to allow specific users to delete recordings. Use the can toggle variable to allow or deny users permission to delete recordings by selecting can or can NOT.
can email recordings	Configure this action to allow specific users to email recordings. Use the can toggle variable to allow or deny users permission to email recordings by selecting can or can NOT.
can export/archive recording	Configure this action to allow specific users to export or archive a recording. Use the can toggle variable to allow or deny users permission to export or archive a recording by selecting can or can NOT.
can modify attributes	Configure this action to allow specific users to modify attributes of a recording. Use the can toggle variable to allow or deny users permission to modify attributes of a recording by selecting can or can NOT.
can modify tags	Configure this action to allow specific users to modify tags of a recording. Use the can toggle variable to allow or deny users permission to modify tags of a recording by selecting can or can NOT.
can play recording	Configure this action to allow specific users to play a recording. Use the can toggle variable to allow or deny users permission to play a recording by selecting can or can NOT.
can retrieve recordings	Configure this action to allow specific users to retrieve recordings. Use the can toggle variable to allow or deny users permission to retrieve recordings by selecting can or can NOT.
can score recordings	Configure this action to allow specific users to score recordings. Use the can toggle variable to allow or deny users permission to score recordings by selecting can or can NOT.
can view attributes	Configure this action to allow specific users to view attributes of a recording. Use the can toggle variable to allow or deny users permission to view attributes of a recording by selecting can or can NOT.
can view the audit trail of the recording	Configure this action to allow specific users to view the audit trail of a recording. Use the can toggle variable to allow or deny users permission to view the audit trail of a recording by selecting can or can NOT.
can view participant contact information	Configure this action to allow specific users to view participant contact information for a recording. Use the can toggle variable to allow or deny users permission to view participant contact information for a recording by selecting can or can NOT.
can view scorecards	Configure this action to allow specific users to view scorecards for a recording. Use the can toggle variable to allow or deny users permission to view scorecards for a recording by selecting can or can NOT.

can view tags	<p>Configure this action to allow specific users to view tags of a recording.</p> <p>Use the can toggle variable to allow or deny users permission to view tags of a recording by selecting can or can NOT.</p>
can view scorecard signature comments	<p>Configure this action to allow specific users to view scorecard signature comments.</p> <p>Use the can toggle variable to allow or deny users permission to view scorecard signature comments by selecting can or can NOT.</p>
can delete scorecards	<p>Configure this action to allow specific users to delete scorecards.</p> <p>Use the can toggle variable to allow or deny users permission to delete scorecards by selecting can or can NOT.</p>
can assign questionnaires	<p>Configure this action to allow specific users to assign questionnaires.</p> <p>Use the can toggle variable to allow or deny users permission to assign questionnaires by selecting can or can NOT.</p>
can modify recording retention period	<p>Configure this action to allow specific users to modify recording retention periods.</p> <p>Use the can toggle variable to allow or deny users permission to modify recording retention periods by selecting can or can NOT.</p>
stop processing more policies	<p>Add this action to a Policy to stop processing policies that follow it. The order of a policy is set in the Policy pane, using the up and down arrows.</p> <p>A Security Policy with the stop processing more policies action only takes effect when both the User entities and Recording Criteria match the recording being evaluated. If either the User entity or the recording criteria in the Security policy with the Stop processing more policies action does not match the recording being evaluated, the evaluation of the current recording does not stop, and policy evaluation continues through the remainder of the policies, until stopped.</p>

Policy Editor Toolbar

Use the toolbar to Change a policy, Copy a policy, Delete a policy, change the order to apply policies, Re-evaluate policies, and Options to export and import policies and view the audit history.

Change Policy

Use the **Change Policy** menu to make updates to a Policy or quickly add Actions to a Policy. To display the Change Policy dialog, in the Policy Pane select a Policy and on the Policy Editor toolbar, click **Change Policy**.

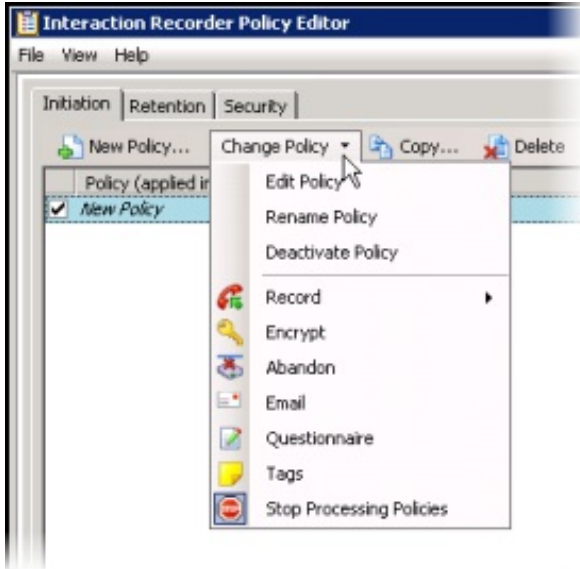

The commands on the **Change Policy** menu allow you to:

- Edit a Policy
- Rename a Policy
- Deactivate a Policy
- Show Policy errors
- Add an Action to a Policy

The Actions on the **Change Policy** menu allow you to add the following Actions to a Policy, based on the Policy Type you are configuring:

- Record
- Encrypt
- Abandon
- Email
- Questionnaire
- Tags
- Location
- Retention
- Delete
- Score
- Play
- Retrieve
- Stop Processing Policies

Edit a Policy

To edit a Policy:

1. Select the Policy in the Policy pane, and click **Change Policy**. The Change Policy menu is displayed.
2. On the Change Policy menu click **Edit Policy**. The Edit Policy dialog is displayed.
3. Use the Edit Policy dialog to make your changes.

You can also double-click a Policy in the Policy pane to display the Edit Policy dialog.

Rename a Policy

To rename a Policy:

1. Select the Policy in the Policy pane, and click **Change Policy**. The Change Policy menu is displayed.
2. On the Change Policy menu click **Rename Policy**. The Rename Policy dialog is displayed.
3. In the name field, type your new name, and click **OK**.

Deactivate/Activate a Policy

To Deactivate a Policy:

1. Select the Policy in the Policy pane, and click **Change Policy**. The Change Policy menu is displayed.
2. On the Change Policy menu click **Deactivate Policy**. In the Policy pane, the check box for the Policy is cleared.

You can also deactivate a Policy by clicking the selected check box in the Policy pane. The check is cleared and the Policy is deactivated.

To Activate a Policy:

1. Select the Policy in the Policy pane, and click **Change Policy**. The Change Policy menu is displayed.
2. On the Change Policy menu click **Activate Policy**. In the Policy pane, the check box for the Policy is selected.

You can also activate a Policy by selecting the Policy check box in the Policy pane.

Show Errors

When there are errors in a Policy, to display the errors:

1. Select the Policy in the Policy pane, and click **Change Policy**. The Change Policy menu is displayed.
2. On the Change Policy menu click **Show Errors**. A window is displayed listing the **Type** of error and an explanation of the error.

You can also display the errors for a Policy by right-clicking the Policy and on the shortcut menu click **Show Errors**.

Adding Actions to a Policy

To quickly add Actions to an existing Policy:

1. Select the Policy in the Policy pane and click **Change Policy**. The Change Policy menu is displayed.
2. On the Change Policy menu, select an Action to apply to the Policy.

When you have completed updating a Policy, and there are no errors, click **Apply** to save the Policy. When you click Apply, the Policies are saved and the italic is removed from the name in the Policy list. When updating Security Policies, the changes take effect immediately when the Security Policy is applied.

Copy

If you want to duplicate an existing policy, click **Copy**. The Copy Policy dialog is displayed. Type a name for the new Policy and click OK. You might want to create a copy of a Policy as a base to modify and test a new policy. When duplicating a policy, note that the Actions that are configured for the policy are displayed by their icons under **Actions** in the Policy pane. Action icons can assist you in quickly seeing what actions are configured for each policy. Here's an example of where the policy Action icons are located in the Policy pane.

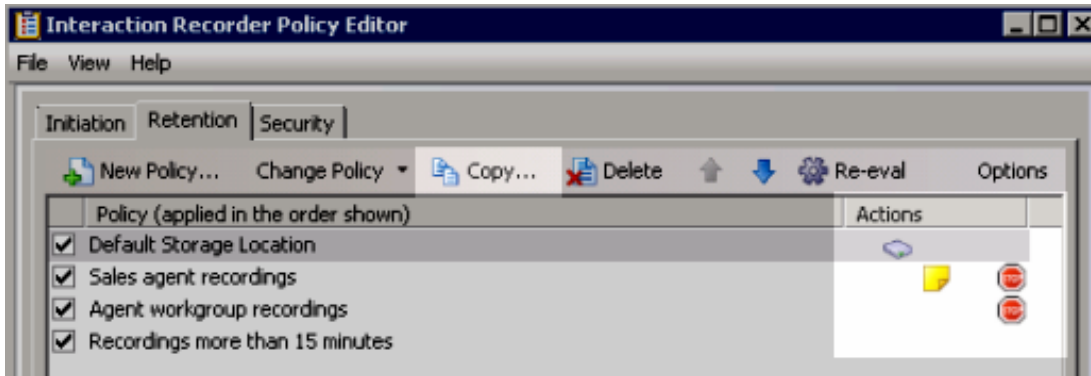

Delete

To delete a policy, select it in the Policy pane, and click **Delete**.

Order

You can change the order policies are applied. Policies are executed in the order they are listed in the Policy pane. To change the order in which policies are applied, in the Policy pane select a Policy. Use the **Up** and **Down** arrows to move the policy to another position in the list, changing the execution order of the Policy.

Re-evaluate

Policies are re-evaluated from top to bottom when an interaction is completed and de-allocates, or when the recording retention expires. When you make a change to a Retention Policy or Security Policy you can immediately re-evaluate the policy by clicking **Re-eval** on the toolbar. For the Re-eval button to be available, all policies need to be saved. On the Re-evaluate retention policies dialog, select which recordings to apply retention policies, or security policies, to.

When policies are in the process of being re-evaluated, a progress indicator is displayed at the bottom of the Policy Editor window.

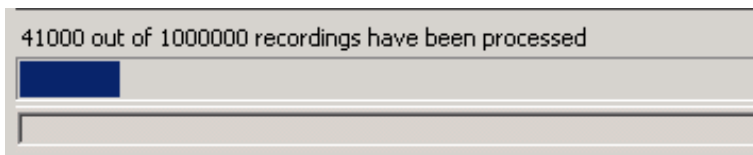

While the progress indicator is displayed, the Re-eval button is replaced with a Cancel button.

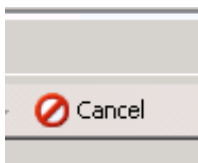

To stop the re-evaluation process, click **Cancel**.

Options

Click Options to:

- Import policies from or Export policies to an external XML file
- View Audit History



Notes:

- If an import is successful, but an element is missing, such as an action, criterion, entity, or event, you will not be allowed to save the policy. A dialog appears providing options that need to be fixed before the policy can be saved.
- If an import fails, a dialog appears and you are not allowed to continue. Information about the failure is available in the logs.

Interaction Recorder Snippet Recording

About Snippet Recordings

Snippet recordings are recordings of calls and chat interactions, created by users and agents in Interaction Desktop and Interaction Connect, and by supervisors in Interaction Supervisor. Using the Snip button, users, with the appropriate security rights, manually initiate and stop Snippet recordings. Unlike ad-hoc recordings that are not managed by Interaction Recorder, using the Snippet recording feature allows contact centers to record a specific segment of a conversation. For example, the Snippet recording feature can be used for various legal purposes, or initiate a recording after obtaining the caller's verbal agreement.

Snippet recordings are configured and managed by Interaction Recorder and stored in the CIC database. Snip creates SASF (Secure Authenticated Stream Format) files. Snippet recordings store not only the interaction recording but also participant and event data, the same as Interaction Recorder policy-based recordings. And snippet recordings can be encrypted, to ensure recordings are secure.

Interaction Recorder Policy Editor Retention policies determine where snippet recordings are stored in CIC and how long they are retained. Policy Editor Security policies determine who has access to view snippet recordings in IC Business Manager. When creating policies, you can also set tags, attributes, and Interaction Quality Manager Questionnaire scorecards for snippet recordings. For more details on creating Policies for Snippet Recordings, see [About Interaction Recorder Policy Editor](#).

Snippet Recordings can also be initiated, stopped, and managed using an IceLib API. Refer to the *Introduction to IceLib Technical Reference* for more information.

Requirements for Snippet Recordings

There are licensing and configuration requirements for Interaction Recorder Snippet Recordings. These requirements are configured in Interaction Administrator.

Licensing for Snippet Recordings

Interaction Recorder Access license for Snippet Recordings

Interaction Recorder Snippet Recordings require the **Interaction Recorder Access** license for each User or Station to be recorded.

The Recorder Access license is required to start and stop Snippet Recordings in Interaction Desktop and Interaction Connect.

The Recorder Access license also allows start and stop of Snippet Recordings from IceLib and ICWS APIs.

The Recorder Access license allows a supervisor to create Snippet recordings from the Agent or Workgroup Queue in the Queues Supervisor views in IC Business Manager. For additional information on Interaction Supervisor licensing requirements for Agents and Workgroup Queues view, see the Interaction Supervisor Help.

Interaction Recorder Client Access license for Snippet Recordings

The **Interaction Recorder Client Access** license is required for users to view and playback snippet recordings in Interaction Recorder client in IC Business Manager.

The Interaction Recorder Client Access license is required to view and modify tag and attribute policy security rights per recording using an IceLib API.

Configuration for Snippet Recordings

Configure the following settings for Interaction Recorder Snippet Recordings in Interaction Administrator.

Configuring Interaction Recorder for Snippet Recordings

To allow Snippet Recordings to be generated on the CIC server, in the Interaction Recorder Configuration dialog on the Recording Generation tab, select **Enable Snippet Recordings**. If this check box is not selected, Snippet Recordings are not generated.

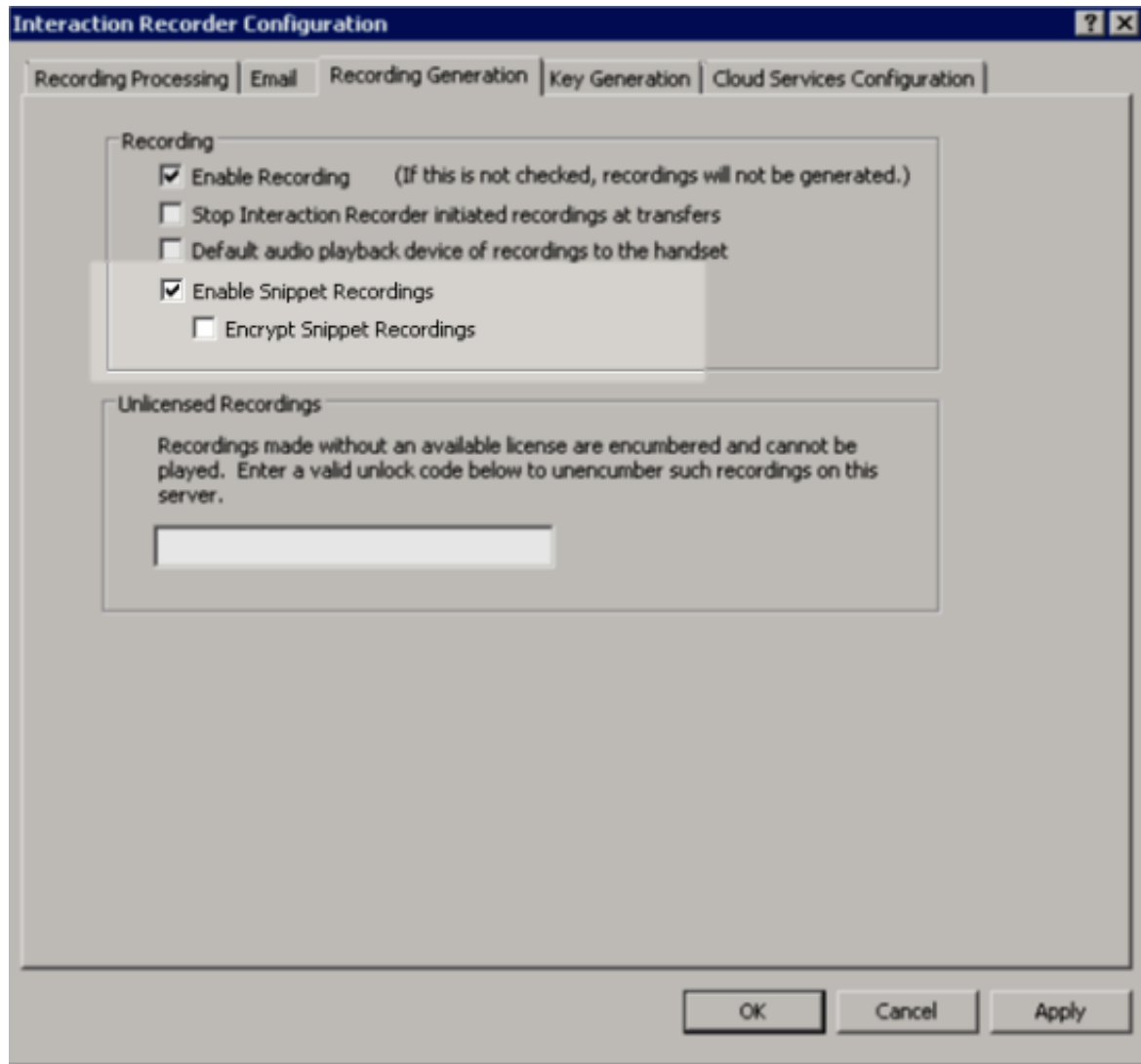

To encrypt Snippet Recordings, be sure you have selected **Enable Snippet Recordings**, and select the **Encrypt Snippet Recordings** check box.

Note

If a policy-based recording is not configured to be encrypted, and snippets are created *and* encrypted for the same interaction, the policy-based recording will also be encrypted.

For additional information on configuring Interaction Recorder Snippet Recordings, see the Interaction Administrator Help.

Assigning Snippet permissions for users

To allow the **Snip** button to be added to the Interaction Desktop toolbar:

1. Open the Configuration dialog for a user or station.
2. Click the **Security** tab, and then click **Security Rights**.
3. In the Search box, type **Snip**.
4. Under **Interaction Command Rights (Restricts when commands are visible in the Client)**, select the **Has Right** check box for **Snip**.
5. To allow a user to access the Snip command in Interaction Desktop **My Interactions**, under **My Interaction Rights**, select the **Has Right** check box for **Snip Interactions**.

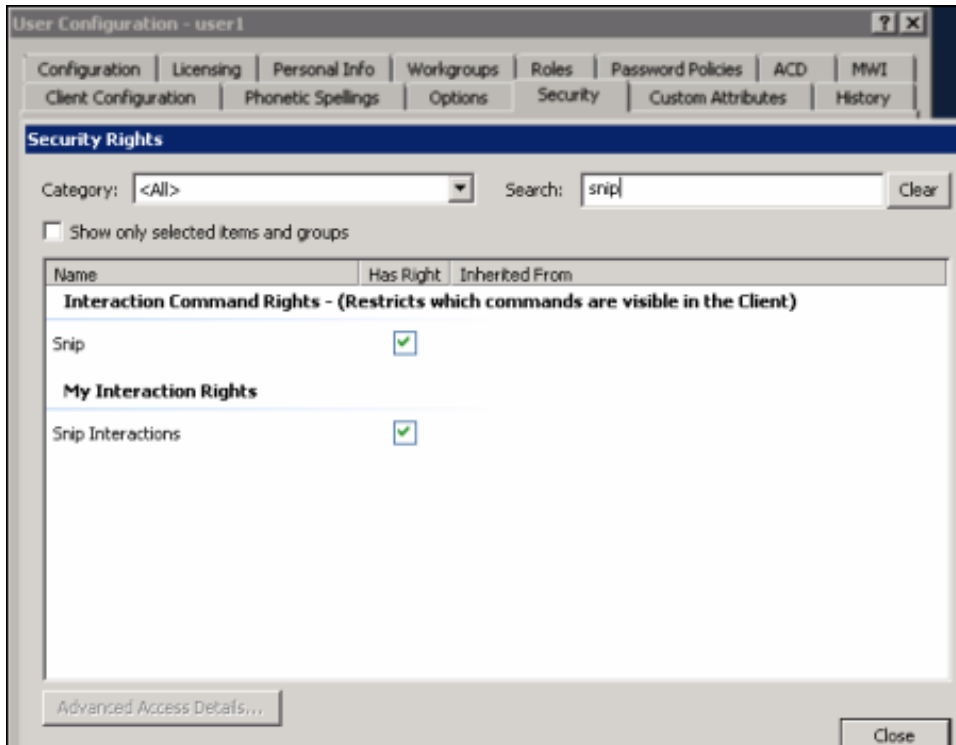

Configuring Interaction Desktop for Snippet Recordings

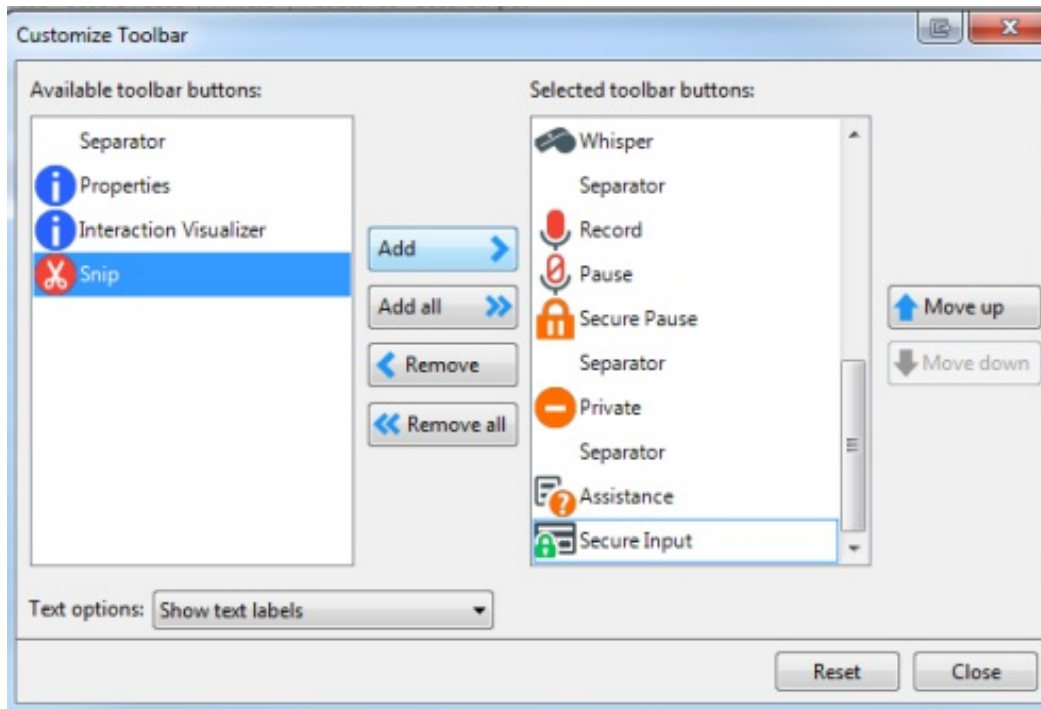

To configure Interaction Desktop for Snippet Recordings, including adding the **Snip** button to toolbars, see the Interaction Desktop (client) Help.

Configuring Interaction Supervisor for Snippet Recordings

To configure Interaction Supervisor for snippet recordings, including Monitor Snip rights, see the Interaction Supervisor Help.

Configuring Email Snippet Recordings

Snippet Recordings of email interactions in Interaction Desktop and Interaction Connect are available only if your CIC administrator separately enables this feature. For information on enabling Email Snippet Recordings, see [Appendix H: Snippet Recordings of Email Interactions](#).

Create a Snippet Recording

Interaction Recorder Snippet Recordings are created using Interaction Desktop, Interaction Connect, and Interaction Supervisor.

Creating a Snippet Recording in Interaction Desktop and Interaction Connect

In Interaction Desktop and Interaction Connect, use the **Snip** button to make recordings of all or selected parts of a call or chat interaction.

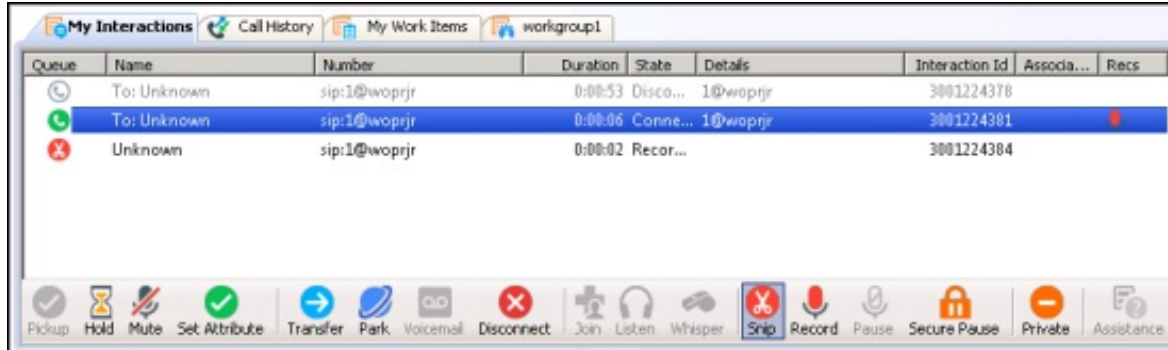

If you try to create both an ad-hoc recording and a snippet recording of the same call or chat interaction, the snippet recording takes precedence.

For more information about creating Snippet Recordings and the differences between Snippet and Ad hoc recordings, see the Interaction Desktop Help.

Creating a Snippet Recording in Interaction Supervisor

In IC Business Manager Interaction Supervisor, supervisors with the appropriate licenses and rights can create Snippet Recordings from the Supervisor Queues and Agent or Workgroup Queue views. When you select an interaction, use the **Snip** button to create a Snippet recording.

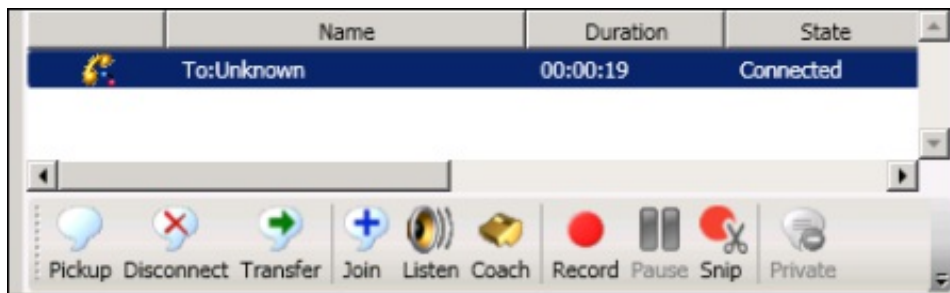

The Snippet recording is displayed on the queue of the Supervisor User that created the Snippet.

For more information about creating Snippet Recordings in Supervisor, see the Interaction Supervisor Help.

Creating an email Snippet Recording



Email Snippet recordings are available as a feature toggle with a server parameter setting. It is important to be aware that an email snippet is the full email, not just a portion of the email. For this reason it is of most value only to customers who choose not to make policy-based recordings of emails or to those who are not recording 100% of email interactions. Partial email recording is not supported due to the fact that the behavior of a recorded email interaction is different than that of call and chat snippets. For information on creating an email Snippet Recording, see [Appendix H: Snippet Recordings of Email Interactions](#).

Viewing Snippet Recordings

Snippet Recordings are viewed in Interaction Recorder in IC Business Manager. A new search attribute **Recording Type**, for Policy-based recordings and Snippet Recordings allows you to search for **Snippet Recordings**.

The screenshot shows a search filter for 'Recording Type'. The operator is set to 'Equal to'. The dropdown menu is open, showing the following options: 'Snippet Recording' (selected), 'Policy-based', and 'Snippet Recording'.

Snippet Recordings in Search Results

When a search is run, the type of recording, Snippet  or Policy-based , is displayed in the **Recording Type** column in the Search Results view.

The screenshot shows the Search Results view for 'Search 1'. The table has the following columns: Media Type, Recording Type, Recording ID, Date/Time, and Recording Length. The data is as follows:

Media Type	Recording Type	Recording ID	Date/Time	Recording Length
		6ba32914-9124-...	1/15/2016 10:33...	00:00:21
		69a32914-9463-...	1/15/2016 10:33...	00:00:39
		93a22914-ecdf-...	1/15/2016 10:18...	00:00:50
		93a22914-996e-...	1/15/2016 10:18...	00:00:52
		8ca22914-f6dd-...	1/15/2016 10:18...	00:00:04

Click on the Recording Type column header to sort recording search results by Recording Type, Snippet and Policy-based.

The screenshot shows the Search Results view for 'Search 1'. The table has the following columns: Media Type, Recording Type, Recording ID, Date/Time, and Recording Length. The data is as follows:

Media Type	Recording Type	Recording ID	Date/Time	Recording Length
		6ba32914-9124-...	1/15/2016 10:33...	00:00:21
		93a22914-ecdf-...	1/15/2016 10:18...	00:00:50
		88182914-a5ba-...	1/13/2016 4:08:...	00:00:14
		8ca22914-f6dd-...	1/15/2016 10:18...	00:00:04
		d2ba2814-1574...	1/12/2016 11:31...	00:00:11

To review the details of a Snippet Recording, select the recording and the information for the recording is displayed in the Media Details and Details panes.

Search Results (14 recordings)

Media Type	Recording Type	Recording ID	Date/Time	Expiration Date	Recording Le	Direction
		4f727615-17b4...	1/3/2019 4:00:08 PM	4/3/2019 5:00:08 PM	00:00:21	Inbound
		30727615-b5ef...	1/3/2019 3:57:56 PM	4/3/2019 4:57:56 PM	00:00:05	Outbound
		30727615-8ea0...	1/3/2019 3:57:55 PM	4/3/2019 4:57:55 PM	00:00:12	Outbound

Media Details

Recording Date: 1/3/2019 3:57:56 PM Recording ID: 30727615-b5ef-d0a6-8110-e981bed10001
Expiration Date: 4/3/2019 4:57:56 PM Initiation Policy:
Interaction ID Key: 100185172130190103 Direction: Outbound
Archived: No Encrypted: No
Recording Length: 00:00:05 Snippet Initiator: user1 user1
Recording Type: Snippet Recording Call Type: External

Details

Participant Data Attributes Audit Trail Scoring Tags Events

Segment 01
 user1 user1 (Interact
 /45

Attribute name	Value
Wrap-up Code	
Interaction Addr...	/10001
Duration	00:00:11
Start Time	1/3/2019 3:57:55 PM
Interaction ID Key	100185172130190103
Role	Initiator
Disconnect Type	Local Disconnect
Display Name	user1 user1 (Interactive Intelligence)

The Media Details pane displays the **Snippet Initiator** attribute value, indicating the user who initiated the Snippet Recording.

Media Details

Recording Date: 1/3/2019 3:57:56 PM Recording ID: 30727615-b5ef-d0a6-8110-e981bed10001
Expiration Date: 4/3/2019 4:57:56 PM Initiation Policy:
Interaction ID Key: 100185172130190103 Direction: Outbound
Archived: No Encrypted: No
Recording Length: 00:00:05 Snippet Initiator: user1 user1
Recording Type: Snippet Recording Call Type: External

Playback a Snippet Recording

To playback the Snippet Recording, in the Recording search results grid, double-click on a snippet recording. The Snippet Recording opens in the playback dialog and the recording plays.

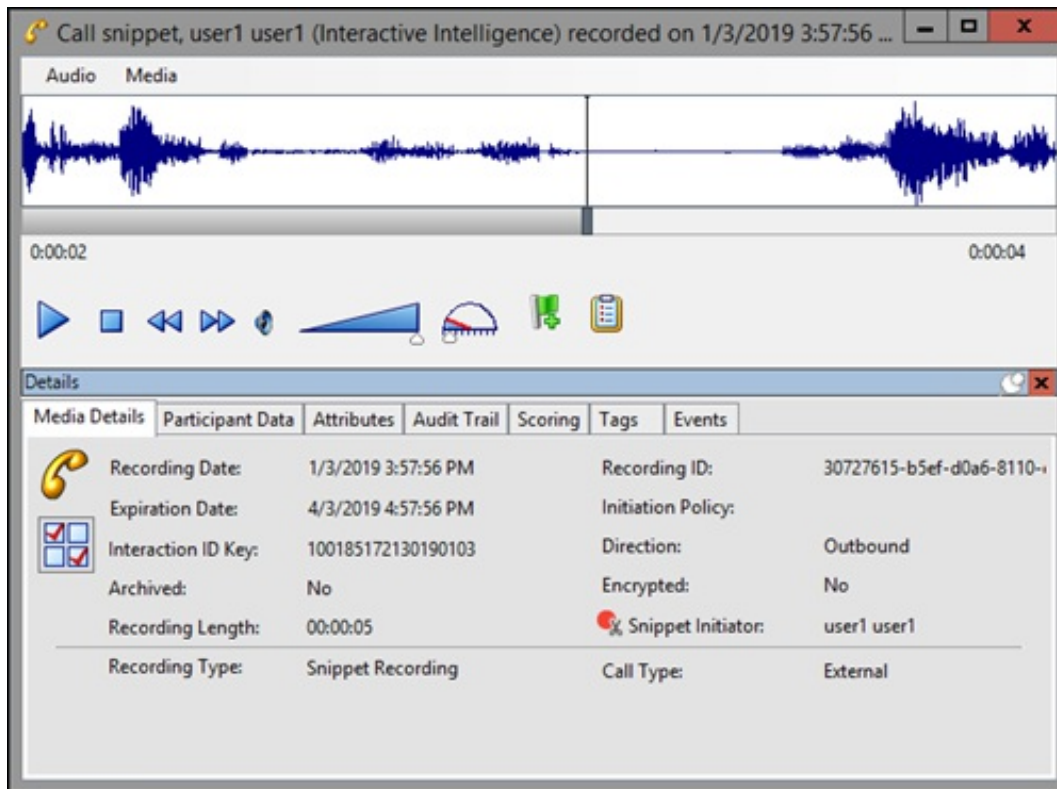





Call snippet, user1 user1 (Interactive Intelligence) recorded on 1/3/2019 3:57:56 ...

Audio Media

0:00:02 0:00:04

Details



Media Details	Participant Data	Attributes	Audit Trail	Scoring	Tags	Events
	Recording Date:	1/3/2019 3:57:56 PM	Recording ID:	30727615-b5ef-d0a6-8110-i		
	Expiration Date:	4/3/2019 4:57:56 PM	Initiation Policy:			
	Interaction ID Key:	100185172130190103	Direction:	Outbound		
	Archived:	No	Encrypted:	No		
	Recording Length:	00:00:05	 Snippet Initiator:	user1 user1		
	Recording Type:	Snippet Recording	Call Type:	External		

Related Recordings

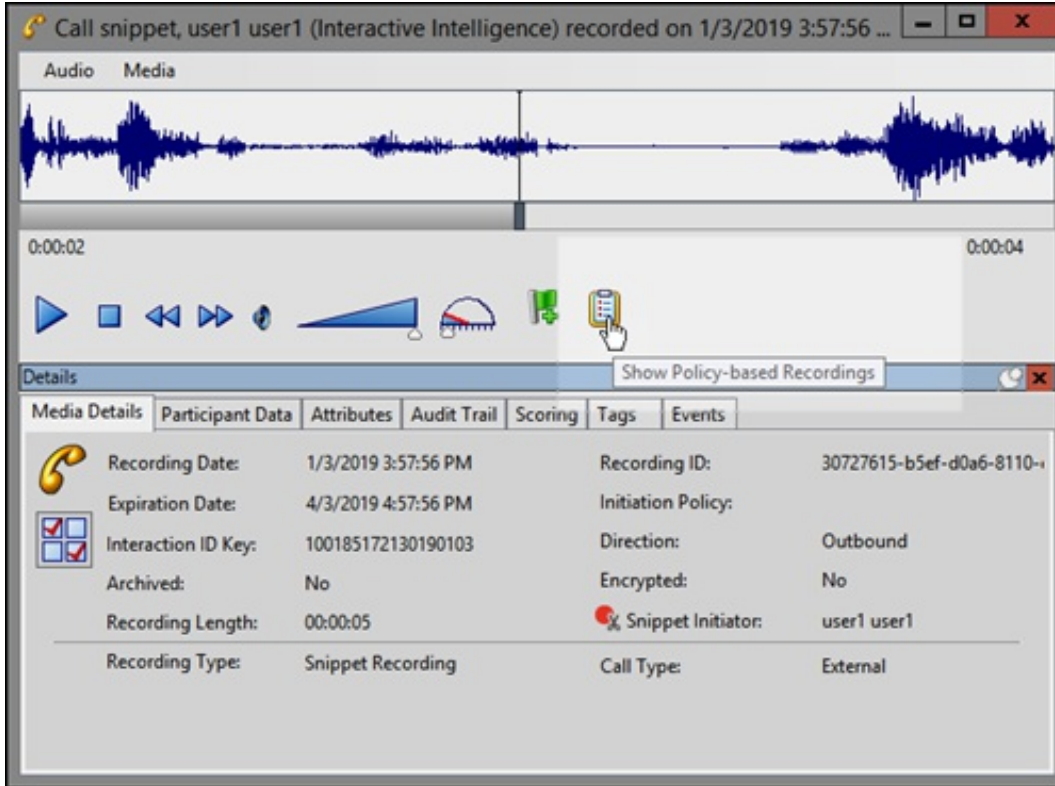
When you are listening to a Snippet Recording, if there is a related Policy-based recording for this interaction, a related recording control is available.



The screenshot displays a call recording player window titled "Call snippet, user1 user1 (Interactive Intelligence) recorded on 1/3/2019 3:57:56 ...". The interface includes an audio waveform at the top, a playback progress bar showing 0:00:02 to 0:00:04, and a control bar with play, stop, previous, next, and volume icons. Below the playback controls is a "Details" panel with a tabbed interface. The "Media Details" tab is active, showing the following information:

Media Details	Participant Data	Attributes	Audit Trail	Scoring	Tags	Events
	Recording Date:	1/3/2019 3:57:56 PM	Recording ID:	30727615-b5ef-d0a6-8110-i		
	Expiration Date:	4/3/2019 4:57:56 PM	Initiation Policy:			
	Interaction ID Key:	100185172130190103	Direction:	Outbound		
	Archived:	No	Encrypted:	No		
	Recording Length:	00:00:05	Snippet Initiator:	user1 user1		
	Recording Type:	Snippet Recording	Call Type:	External		

To display a list of Policy-based recordings related to the Snippet Recording, click the Policy control. To open a related recording, select a recording from the list.

For additional information on viewing and playing recordings, see [Recording Search](#).

Using Interaction Recorder Client

About Interaction Recorder

Interaction Recorder Built-In Workspace is used to search and play back media recordings such as phone calls, web chats, emails, social media interactions, and screen recordings. **Interaction Quality Manager Built-In Workspace** is used to create questionnaires.



Interaction Recorder is also used to Score recordings and search and view scorecards. The Interaction Quality Manager license is required to score recorded interactions for quality evaluation. Live call recordings, in progress, can also be monitored using Interaction Recorder.

Audio recordings can be played back through your computer speakers, headset, or telephone handset.

Using Interaction Recorder for IC Business Manager, you can open multiple recordings and switch between those recordings while reviewing them.

Interaction Recorder has an intuitive user interface to help you build effective searches to display stored recordings, playback those recordings, and search and view scorecards. You can also use Interaction Quality Manager to create questionnaires for scoring and quality assessment of a recording.

Use Interaction Recorder Client for IC Business Manager to:

- Build searches to retrieve recordings
- Build searches to retrieve scorecards
- View recording details
- Playback recordings
- Monitor live call recordings in progress
- Create questionnaires for assessing a recording
- Score recordings
- Send a recording in an email
- Export recordings
- Archive recordings

Interaction Quality Manager View

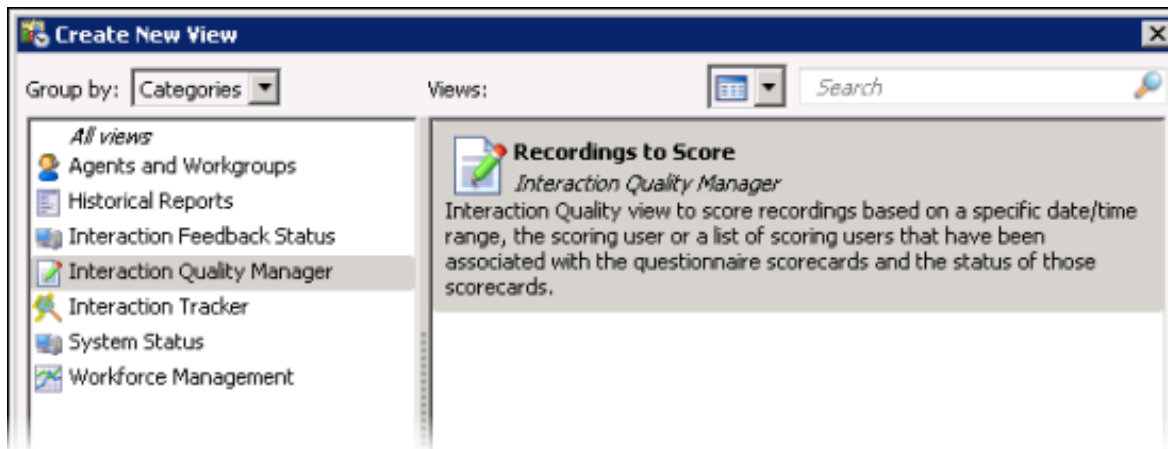

Interaction Quality Manager Recordings to Score New View is used to retrieve recordings with associated Questionnaire Scorecards that need to be scored. The view also displays the scorecard status.

About the Interaction Recorder Client User Interface

Interaction Recorder and Interaction Quality Manager Workspaces use the IC Business Manager user interface, which makes it easier to navigate your options when creating searches, viewing stored recordings and scorecards, and creating questionnaires. The interface includes menus, toolbars, navigation panes, and workspaces.

The **Interaction Recorder** navigation pane provides easy access to create recording searches and scorecard searches, using the **Searches** navigation pane. The **Recordings** navigation pane displays recordings that are open in the workspace.

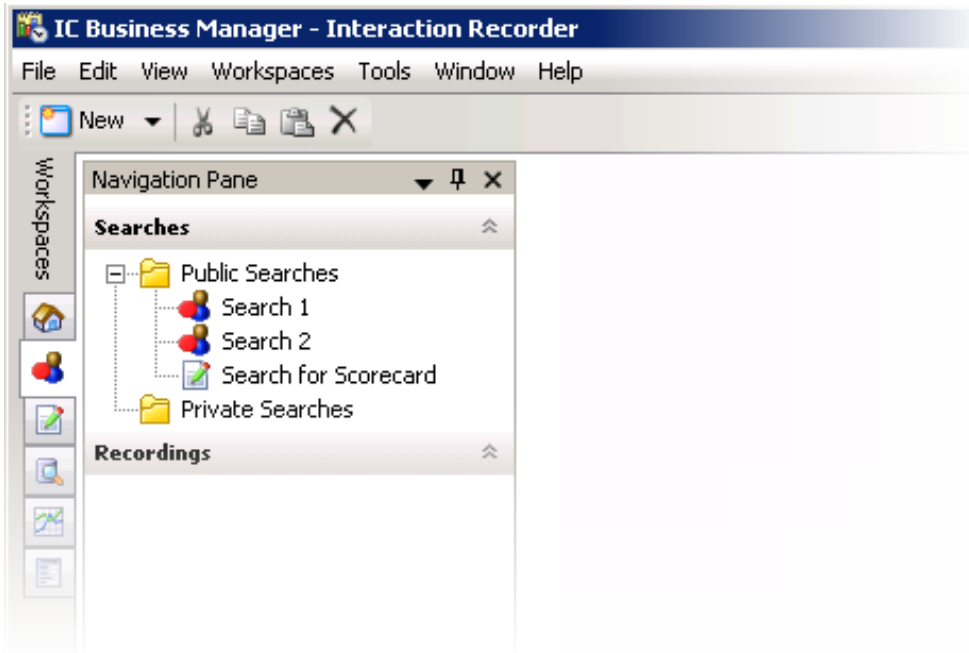

The **Interaction Quality Manager** navigation pane provides easy access to create questionnaires.

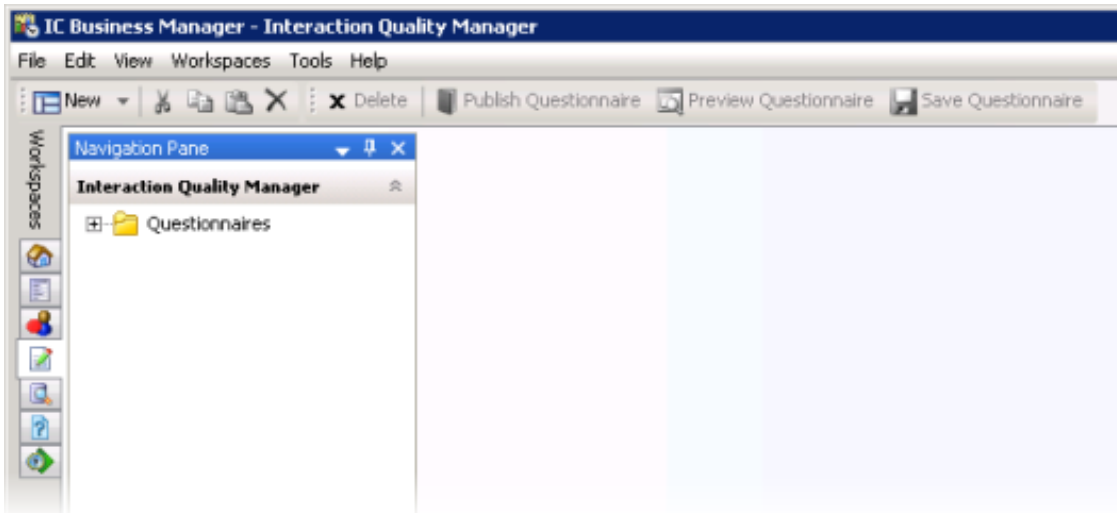

Create a Search

Use **Searches** in the Navigation pane to quickly build **Public** and **Private** searches for retrieving recorded interactions and viewing scorecards.

Recording Search

Recording searches are easily created in the workspace by selecting search attributes that are grouped into six main categories: Interaction Analyzer, Interactions, Media Specific, Questionnaires, Survey, and Advanced. Note: Additional licensing is required for Interaction Analyzer, Questionnaires, and Survey recording searches.

After you create a recording search, simply run the search and the results are displayed in a list of recorded interactions in the Searches View in the workspace.

Recording searches are created to retrieve recorded interactions. In the Navigation pane, you can create Public and Private Searches. Searches are then easily built in the workspace using the SearchBuilder control and selecting search attributes. Search Attributes are grouped into six main categories:

- Interaction Analyzer
- Interactions
- Media Specific
- Questionnaires
- Survey
- Advanced

After adding an attribute to your search, use the SearchBuilder control to configure simple and rich attributes in the workspace.

Public Searches for Recordings

Public searches can be seen and managed by all users on a server that have been assigned an Interaction Recorder Client Access license in Interaction Administrator.

Creating a Public Search for Recordings

Public Searches that a user creates, for public sharing, are stored in **Public Searches**. Folders can be created to store searches or searches can be stored directly in the Public Searches folder.

Creating a folder to contain your recording search

To create a folder to contain your search:

1. In the Searches pane, select **Public Searches**.



2. Right-click, and on the shortcut menu, point to **New**, and click **Folder**. A New Folder is selected under Public Searches.
3. Right-click the new folder and click **Rename**.
4. Type a name for the folder and click **Enter**.

Creating a search

To create a search to be stored in a folder:

1. Select the folder, right-click, and on the submenu point to **New** and click **Recording Search**. The Create Recording Search dialog is displayed in the workspace.

Note To create a search directly in the Public Searches folder, right-click on the **Public Searches** folder and follow the same steps.

2. To name your search, in the **Title** box type a name for your search.
3. In the **Max results** box, type the number for the maximum number of results to display. The default is 100.

Adding Attributes to a Recording Search

Use the SearchBuilder control to select attributes to add to your search. Simple and rich attributes can be added. Sub-instances can be added to a simple attribute, and rich attributes contain multiple sub-fields. First, add an attribute to your search.

To add an attribute to your search:

1. In the **New Attribute** drop-down list, point to the type of attribute you want to include. A submenu is displayed with a list of available attributes for the type you have selected.
2. In the submenu, click the attribute. The attribute control is added to the workspace.

For detailed information on attributes, see [Recording Search Attributes](#).

Configuring a simple attribute

A simple attribute contains an operator and a field value that can be a string, list, or numeric type value. To configure a simple attribute:

1. Select the operator.
2. Configure the values for the attribute.

Working with attributes

Attributes within the search are logically AND'd together. You can add in a UNION operator in-between attributes to logically OR them together. To do this, right-click in the workspace, and click **UNION Operator**.





Use the Up and Down buttons to prioritize the order in which the attributes and unions should be considered when running the search. These controls are also available on the right-click shortcut menu.



Use the Delete button to remove an attribute from the search. Delete is also available from the right-click shortcut menu.

Adding sub-instances to a simple attribute

When a simple attribute has been added to the workspace, the Add More button  is displayed in the upper right corner of the attribute control. To add an additional sub-instance of the attribute:



1. First, in the SearchBuilder control on the workspace, select the attribute. A highlighted selection rectangle appears around the attribute control to indicate it is the active attribute, and the Add More  button is displayed.
2. Click Add More . The attribute sub-instance is nested within the parent control, with an additional operator and field value control.

Note

After you have added the number of sub-instances allowed by the attribute, the  is no longer displayed as an option. For example, **Direction** has four available attributes: Inbound, Intercom, Outbound, and Unknown. After three sub-instances have been added to the original attribute, the Add More icon is no longer displayed.

Deleting sub-instances from a simple attribute

When more than one sub-instance is included in a simple attribute, the Delete More button  is available to the right of the active sub-instance, allowing you to delete the sub-instance. To do this:

1. In the search builder control on the workspace, in the attribute, select the sub-instance. The Delete More button  is displayed next to the sub-instance.
2. Click Delete More . The sub-instance is removed from the attribute.

Configuring a rich attribute

Rich attributes contain multiple sub-fields. Sub-fields are logically OR'd together within the search. To configure a rich attribute:

1. In the SearchBuilder control on the workspace, select the attribute. A highlighted selection rectangle appears around the attribute control to indicate it is the active attribute.
2. Depending on the type of rich attribute you selected, configure the operator values.
3. Use the Up and Down buttons  to prioritize the order in which the attributes and unions should be considered when running the search.

When all attributes have been configured for your search, click **Create Search**. The search is executed, the name of the search is displayed under the folder in the Navigation Pane, and the search results are displayed in the workspace. For more details, see [Run and View a Search](#).

Private Searches for Recordings

Private searches can be built, viewed, configured, and run only by the owner of the search.

Creating a Private Search for Recordings

Folders can be created to store searches or searches can be stored directly in the Private Searches folder.

Creating a folder to contain your recording search

To create a folder to contain your search:

1. In the **Searches** pane, select **Private Searches**.



2. Right-click, and on the shortcut menu, point to **New**, and click **Folder**. A **New Folder** is selected under Private Searches.
3. Right-click the new folder and click **Rename**.
4. Type a name for the folder and click **Enter**.

Creating a search

To create a search to be stored in a folder:

1. Select the folder, right-click, and on the submenu point to **New** and click **Recording Search**. The Create Recording Search dialog is displayed in the workspace.

Note To create a search directly in the Private Searches folder, right-click on the **Private Searches** folder and follow the same steps.

2. To name your search, in the **Title** box type a name for your search.
3. In the **Max results** box, type the number for the maximum number of results to display. The default is 100.

Adding Attributes to a Recording Search

Use the SearchBuilder control to select attributes to add to your search. Simple and rich attributes can be added. Sub-instances can be added to a simple attribute, and rich attributes contain multiple sub-fields. First, add an attribute to your search.

To add an attribute to your search:

1. In the **New Attribute** drop-down list, point to the type of attribute you want to include. A submenu is displayed with a list of available attributes for the type you have selected.
2. In the submenu, click the attribute. The attribute control is added to the workspace.

For detailed information on attributes, see [Recording Search Attributes](#).

Configuring a simple attribute

A simple attribute contains an operator and a field value that can be a string, list, or numeric type value. To configure a simple attribute:

1. Select the operator.
2. Configure the values for the attribute.

Working with attributes

Attributes within the search are logically AND'd together. You can add in a UNION operator in-between attributes. To do this, right-click in the workspace, and click **UNION Operator**.





Use the Up and Down buttons to prioritize the order in which the attributes and unions should be considered when running the search. These controls are also available on the right-click shortcut menu.



Use the Delete button to remove an attribute from the search. Delete is also available from the right-click shortcut menu.

Adding sub-instances to a simple attribute

When a simple attribute has been added to the workspace, the Add More button  is displayed in the upper right corner of the attribute control. To add an additional sub-instance of the attribute:



1. First, in the SearchBuilder control on the workspace, select the attribute. A highlighted selection rectangle appears around the attribute control to indicate it is the active attribute, and the Add More  button is displayed.
2. Click Add More . The attribute sub-instance is nested within the parent control, with an additional operator and field value control.

Note

After you have added the number of sub-instances allowed by the attribute, the  is no longer displayed as an option. For example, **Direction** has four available attributes: Inbound, Intercom, Outbound, and Unknown. After three sub-instances have been added to the original attribute, the Add More icon is no longer displayed.

Deleting sub-instances from a simple attribute

When more than one sub-instance is included in a simple attribute, the Delete More button  is available to the right of the active sub-instance, allowing you to delete the sub-instance. To do this:

1. In the SearchBuilder control on the workspace, in the attribute, select the sub-instance. The Delete More button  is displayed next to the sub-instance.
2. Click Delete More . The sub-instance is removed from the attribute.

Configuring a rich attribute

Rich attributes contain multiple sub-fields. Sub-fields are logically OR'd together within the search. To configure a rich attribute:

1. In the SearchBuilder control on the workspace, select the attribute. A highlighted selection rectangle appears around the attribute control to indicate it is the active attribute.
2. Depending on the type of rich attribute you selected, configure the operator values.
3. Use the Up and Down buttons  to prioritize the order in which the attributes and unions should be considered when running the search.

When all attributes have been configured for your search, click Create Search. The search is executed, the name of the search is displayed under the folder in the Navigation Pane, and the search results are displayed in the workspace. For more details, see [Run and View a Search](#).

Add Attributes to a Recording Search

After you have created a Public or Private search, use the SearchBuilder control, displayed in the workspace, to add and configure attributes in your search.

Adding Attributes to a Recording Search

To display SearchBuilder in the workspace, select a search in the Searches pane. The search is displayed in the workspace, and the SearchBuilder is displayed with the **New Attribute** drop-down list.

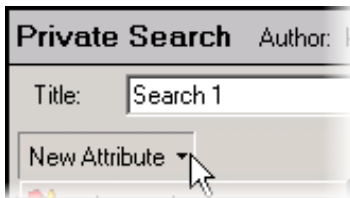

When you click **New Attribute**, the following types of recording attributes are displayed:

- Interaction Analyzer
- Interactions
- Media Specific
- Questionnaires
- Survey
- Advanced

To select an attribute, point to the type of attribute you want to add to your search, and the available attributes are displayed in a submenu. Simple and rich attributes can be added to your search. Sub-instances can be added to a simple attribute, and rich attributes contain multiple sub-fields.

For detailed information on attributes, see [Recording Search Attributes](#).

Adding Attributes to a Search

Use the SearchBuilder control to select attributes to add to your search. To add an attribute to a search:

1. In the **New Attribute** drop-down list, point to the type of attribute you want to include. A submenu is displayed with a list of available attributes for the type you have selected.
2. In the submenu, click the attribute. The attribute control is added to the workspace.

An attribute might be a simple attribute or a rich attribute. A simple attribute contains an operator and a field value that can be a string, list, or numeric type value. A rich attribute contains multiple sub-fields.

To configure a simple attribute:

1. In the SearchBuilder control on the workspace, select the attribute. A highlighted selection rectangle appears around the attribute control to indicate it is the active attribute.
2. Select the operator for the attribute
3. Configure the values for the attribute

To configure a rich attribute:

1. In the SearchBuilder control on the workspace, select the attribute. A highlighted selection rectangle appears around the attribute control to indicate it is the active attribute.
2. Depending on the type of rich attribute you selected, configure the operator values.

Attributes within the search are logically AND'd together. You can add in a UNION operator in-between attributes. To do this, right-click in the workspace, and click **UNION Operator**.

Arranging attributes within a search attribute



Use the Up and Down buttons  to prioritize the order in which the attributes and unions should be considered when running the search. These controls are also available on the right-click shortcut menu.



Deleting an attribute from the search



Use the Delete button  to remove an attribute from the search. Delete is also available from the right-click shortcut menu.

Adding sub-instances to a simple attribute

When a simple attribute has been added to the workspace, the Add More button  is displayed in the upper right corner of the attribute control. To add an additional sub-instance of the attribute:

1. First, in the SearchBuilder control on the workspace, select the attribute. A highlighted selection rectangle appears around the attribute control to indicate it is the active attribute, and the Add More  button is displayed.
2. Click Add More . The attribute sub-instance is nested within the parent control, with an additional operator and field value control.

Note

After you have added the number of sub-instances allowed by the attribute, the  is no longer displayed as an option. For example, **Direction** has four available attributes: Inbound, Intercom, Outbound, and Unknown. After three sub-instances have been added to the original attribute, the Add More icon is no longer displayed.

Deleting sub-instances from a simple attribute

When more than one sub-instance is included in a simple attribute, the Delete More button  is available to the right of the active sub-instance, allowing you to delete the sub-instance. To do this:

3. In the SearchBuilder control on the workspace, in the attribute, select the sub-instance. The Delete More button  is displayed next to the sub-instance.

Click Delete More . The sub-instance is removed from the attribute.

Recording Search Attributes

The information in the following table describes the available Recording Search attributes that are used to create recording searches for recorded interactions. These attributes are available in the search builder control when a recording search is displayed in the workspace.

The Recording Search Attributes are defined by the following types:

- Interaction Analyzer
- Interactions
- Media Specific
- Questionnaires
- Survey
- Advanced

Attribute Type	Attribute	Description
Interaction Analyzer	Agent Keyword Score	<p>The Agent Keyword Score attribute searches for recordings that contain Interaction Analyzer Keywords that have a matching Negative Score, Positive Score, or Total score based on the selection in the first drop-down list box.</p> <p>Available operators for Agent Keyword Score include Equal to, Not equal to, Greater than, Greater than or equal to, Less than, Less than or equal to, Is empty, or Is not empty.</p> <p>For information on Interaction Analyzer Keywords, see the <i>Interaction Analyzer Technical Reference</i> in the PureConnect Documentation Library.</p>
	Customer Keyword Score	<p>The Customer Keyword Score attribute searches for recordings that contain Interaction Analyzer Keywords that have a matching Negative Score, Positive Score, or Total score based on the selection in the first drop-down list box.</p> <p>Available operators for Customer Keyword Score include Equal to, Not equal to, Greater than, Greater than or equal to, Less than, Less than or equal to, Is empty, or Is not empty.</p> <p>For information on Interaction Analyzer Keywords, see the <i>Interaction Analyzer Technical Reference</i> in the PureConnect Documentation Library.</p>

	<p>Total Keyword Score</p>	<p>The Total Keyword Score attribute searches for recordings that contain Interaction Analyzer Keywords that have a matching Negative Score, Positive Score, or Total score based on the selection in the first drop-down list box.</p> <p>Available operators for Total Keyword Score include Equal to, Not equal to, Greater than, Greater than or equal to, Less than, Less than or equal to, Is empty, or Is not empty.</p> <p>For information on Interaction Analyzer Keywords, see the <i>Interaction Analyzer Technical Reference</i> in the PureConnect Documentation Library.</p>
	<p>Interaction Was Analyzed</p>	<p>The Interaction Was Analyzed attribute searches for recordings that <i>were</i> analyzed for keywords <u>or</u> recordings that were <i>not</i> analyzed for keywords.</p> <p>This attribute is configured to search recordings by the audio channel, for either Agent channel, Customer channel, or both channels.</p> <p>Select Yes to search for recordings that <i>were</i> analyzed for keywords. Select No to search for recordings that were <i>not</i> analyzed for keywords.</p> <p>To configure the search to select recordings by <i>either</i> the Agent audio channel or by the Customer audio channel, select the Specify channel analyzed check box, and in the drop-down list select either Agent or Customer.</p> <p>To configure the search to select recordings by <i>both</i> the Agent and Customer audio channels, clear the Specify channel analyzed check box. For example: selecting Yes and clearing the Specify channel analyzed check box returns recordings that have been analyzed for keywords by the Agent or Customer. Or, for example, if you want to search for recordings that were <i>not</i> analyzed for any agents, select No and select the Specify channel analyzed check box, and select the Agent channel.</p>
	<p>Keyword</p>	<p>The Keyword attribute searches for recordings that contain Interaction Analyzer keywords.</p> <p>Available operators for Keyword include: Equal to, Not equal to, Contains, Does not contain, Is empty, and Is not empty.</p> <p>You can use the drop-down list to select a Keyword or you can begin typing a keyword to display available keywords to choose from.</p> <p>Keyword is a simple attribute that can contain sub-instances.</p> <p>For information on Interaction Analyzer Keywords, see the <i>Interaction Analyzer Technical Reference</i> in the PureConnect Documentation Library.</p>

	<p>Keyword Set Category</p>	<p>The Keyword Set Category attribute searches for recordings that contain keywords based on the Keyword Set Category.</p> <p>Available operators for Keyword Set Category include: Available operators for Keyword include: Equal to, Not equal to, Contains, Does not contain, Is empty, and Is not empty.</p> <p>You can use the drop-down list to select a Category or you can begin typing a Category to display available categories to choose from.</p> <p>Keyword Set Category is a simple attribute that can contain sub-instances.</p> <p>For information on Interaction Analyzer Keywords, see the <i>Interaction Analyzer Technical Reference</i> in the PureConnect Documentation Library.</p>
	<p>Keyword Score</p>	<p>The Keyword score attribute searches for recordings that contain Interaction Analyzer Keywords and have a matching Customer/Agent Positive or Negative score based on the selected operator.</p> <p>Available operators for Keyword Score include Equal to, Greater than, Greater than or equal to, Less than, Less than or equal to, or Not equal to.</p> <p>Keyword Score is a simple attribute that can contain sub-instances.</p> <p>For information on Interaction Analyzer Keywords, see the <i>Interaction Analyzer Technical Reference</i> in the PureConnect Documentation Library.</p>
	<p>Keyword Set Name</p>	<p>The Keyword Set Name attribute searches for recordings that contain keywords based on the Keyword Set Name.</p> <p>Available operators for Keyword Set Category include: Available operators for Keyword include: Equal to, Not equal to, Contains, and Does not contain.</p> <p>You can use the drop-down list to select a Name or you can begin typing a Name to display available names to choose from.</p> <p>For information on Interaction Analyzer Keywords, see the <i>Interaction Analyzer Technical Reference</i> in the PureConnect Documentation Library.</p>
	<p>Spotted Keyword Confidence</p>	<p>The Spotted Keyword Confidence attribute searches for recordings based on the Confidence Threshold percentage defined for a Keyword.</p> <p>Available operators for Spotted Keyword Confidence are: Greater than, Greater than or equal to, Less than, and Less than or equal to.</p> <p>For information on Interaction Analyzer Keywords, see the <i>Interaction Analyzer Technical Reference</i> in the PureConnect Documentation Library.</p>

<p>Interactions</p>	<p>Account Code</p>	<p>Use an Account Code, which is an identifying numeric code, assigned to an account name, that has been associated with an outgoing or incoming interaction, as an argument for your search.</p> <p>Available operators include: Contains, Does not contain, Equal to, Is empty, Is not empty, or Not equal to.</p> <p>Type a numerical value for the argument in the value field. Note that Account Codes are treated as strings. so leading zeros in an account code number must be included in the value entered.</p> <p>Account Code is a simple attribute that can contain sub-instances.</p> <p>Note: Screen Recordings are not returned on searches using this attribute, as screen recordings are not associated with Tracker Segments.</p>
	<p>Assigned Workgroup</p>	<p>Use a Workgroup in your search, which is a defined logical group of Users related by function, department, project, or other organization and used for ACD call processing queues.</p> <p>Available operators include: Contains, Does not contain, Equal to, Is empty, Is not empty, or Not equal to.</p> <p>In the value field, type a Workgroup name or select an available Workgroup from the drop-down list. The list of available workgroups is filtered by the workgroup access rights the user has when logging on to IC Business Manager. Note, you can also type an obsolete workgroup name in this field.</p> <p>Assigned Workgroup is a simple attribute that can contain sub-instances.</p> <p>Note: Screen Recordings are not returned on searches using this attribute, as screen recordings are not routed through workgroup queues.</p>
	<p>Date/Time</p>	<p>Date/Time is a rich attribute that contains multiple sub-fields. You can select: Specify a date/time range, Specify a date period, or Specify shift date/time period. Operands are displayed depending on your selection.</p> <p>For Specify a date/time range, specify a date argument using the drop-down box and selecting a date from the calendar. Type or select a time to specify a time argument.</p> <p>For Specify a date period, specify a date in which the interactions occurred to be included in the search: Today, Last week, Last month, Last N hours, or Last N days.</p> <p>For Specify shift date/time period, specify a shift date range and time of day range. For example, a shift date/time might be Monday through Friday, 8:00 a.m. to 5:00 p.m.</p> <p>This attribute uses the Windows time zone set for the Windows User on the Interaction Recorder Client machine.</p>

<p>Has Related Recordings</p>	<p>Select this attribute to search for recordings that have related recordings or do not have related recordings.</p> <p>Select Yes to return recordings in the search results that have a related recording. Related recordings apply to all media types, such as screen recordings and replies to e-mails.</p> <p>Select No to return recordings in the search results that do not have any related recordings.</p>
<p>Holds</p>	<p>Search Attributes for Interactions > Holds</p> <p>There are three Holds Search Attributes: Number of Holds, Hold Time, and Total Hold Time.</p> <p>Number of Holds</p> <p>Select this attribute to search for recordings by specifying the number of holds in a recording. Select an operator and enter the number of Holds in the field. A valid value for the number of Holds is 0 or a positive integer.</p> <p>Note: When the Number of Holds operator is configured as Equals to and the value is set to 0, only recordings that <i>do not</i> have Holds are retrieved. Available operators are: Equal to, Greater than, Greater than or equal to, Less than, and Less than or equal to. The Less than and Less than or equal to operators <i>include</i> recordings that have no Hold events. To specify the Hold type, select the Specify hold type check box and select Hold or Transfer or Park.</p> <p>Hold Time</p> <p>Select this attribute to search for recordings by specifying an individual Hold time in a recording. Select an operator and enter a time in hh:mm:ss in the field. Available operators are: Equal to, Greater than, Greater than or equal to, Less than, and Less than or equal to. To specify the Hold type, select the Specify hold type check box and select Hold or Transfer or Park.</p> <p>Notes for Hold Time attribute:</p> <ul style="list-style-type: none"> • The less than and Less than or equal to operators only retrieve recordings for which there is at least one Hold event. • When the Hold Time operator is configured as Equals to and the value is set to 0, only recordings that have at least one zero-second hold are retrieved. <p>Total Hold Time</p> <p>Select this attribute to search for recordings by specifying the sum of all hold times for a recording. Available operators are: Equal to, Greater than, Greater than or equal to, Less than, and Less than or equal to. To specify the Hold type, select the Specify hold type check box and select Hold or Transfer or Park.</p> <p>Notes for Total Hold Time attribute:</p> <ul style="list-style-type: none"> • The less than and Less than or equal to operators only retrieve recordings for which there is at least one Hold event. • When the Total Hold Time operator is configured as Equals to and the value is set to 0, recordings that have no holds as well as recordings that have at least one zero-second hold are retrieved. <p>Hold Type Events</p> <p>You can specify a Hold type to associate with a Holds search attribute. Holds event types are: Hold, Transfer, and Park. A Hold event type indicates the Hold button was used</p>

		<p>to place a recording participant on hold; the Hold event duration indicates the amount of time the participant was on hold.</p> <p>A Transfer event type indicates a recording participant was transferred to another entity during the recording; the Transfer event duration indicates the amount of time the participant was on hold while the interaction was being transferred.</p> <p>A Park event type indicates the Park on Queue button was used to park a recording participant on a queue. The Park event duration indicates the amount of time the participant was on hold before the parked call was picked up from the queue.</p> <p>Note A Park Hold type search can only be run against a CIC Server running CIC 2018 R1, or later.</p>
	<p>Initiation Policy</p>	<p>Select this attribute to search for recordings based on an Initiation Policy. Select an operator, and enter the Initiation Policy name in the field.</p> <p>Available operators include: Contains, Does not contain, Equal to, Is empty, Is not empty, or Not equal to.</p> <p>You can use the drop-down list to select an Initiation Policy or you can begin typing a name to display available Initiation Policies to choose from.</p> <p>The Initiation Policy attribute can include sub-instances.</p>
	<p>Interaction Address</p>	<p>Select this attribute to search for recordings based on the Interaction Address.</p> <p>Available operators include: Contains, Does not contain, Equal to, Is empty, Is not empty, or Not equal to.</p> <p>Note: Screen Recordings are not returned on searches using this attribute, as screen recordings do not have interaction addresses.</p>
	<p>Direction</p>	<p>Select this attribute to search for recordings based on the Interaction Direction (Inbound, Intercom, Outbound, or Unknown).</p> <p>Note: The owner of an intercom recording is the person who is receiving the call.</p> <p>The Direction attribute can include sub-instances.</p>

<p>Interaction ID</p>	<p>The Interaction ID uniquely identifies an interaction in a CIC system. An Interaction ID is assigned every time an interaction takes place. An Interaction ID identifies the <i>interaction</i> that got recorded.</p> <p>Interaction IDs are useful in finding recordings when you use the Contains operator along with the Call Id, from the Interaction Desktop.</p> <p>Use the Interaction ID as a simple attribute for your search.</p> <p>Type a numerical value for the argument in the value field.</p> <p>The Interaction ID attribute can include sub-instances.</p> <p>The speed of the search and the number of recordings returned in your search results is based on the characters entered in the Interaction ID value field. For example:</p> <ul style="list-style-type: none"> - If you enter 18 characters, the search results will include the recording that has the Interaction ID that matches the value entered. - If you enter 10 characters, the search results will contain a list of recordings that have Interaction IDs that start with these 10 characters. - If you enter any other number of characters, for example 1 through 9 characters or 11 through 17 characters, the search results will contain a list of recordings that contain the value entered anywhere in the Interaction ID.
<p>Media Type</p>	<p>Select this attribute to search for recordings based on the interaction media type. Available Media types include: Call, Chat, Chat Transcript, E-mail, Screen, Social Conversation, and Social Direct Message.</p>
<p>Participant Information</p>	<p>Add this attribute to your search to include recordings based on identifiers of a party that are included in the recording. All the fields specified are OR'd together for the search.</p> <p>The sub-fields for this rich attribute include information sub-fields for participant values, including: Last Name, First Name, Phone Number, Email Address, a Participant Type drop-down list that includes predefined types. Note, if you want all recordings where a specific participant has a Participant Type (or has any other Participant Information fields other than first and last names), use the Participant Name search criteria in addition to Participant Information criteria.</p> <p>Also included is a Station Name sub-field that includes: an operator drop-down list that displays the operators Contains, Does not contain, Equal to, and Not equal to; and a Station Name field drop-down list that displays a list of current station names to choose from. Note, you can also type an obsolete station name in this field.</p> <p>Note: Screen Recordings are not returned on searches using this attribute, as screen recordings do not have participants or station names.</p>

<p>Participant Name</p>	<p>Add this attribute to your search to include recordings based on the participant's name. The first and last name are AND'ed together for the search.</p> <p>Available operators include: Equal to, Not equal to, Contains, or Does not contain.</p> <p>In the First Name field, type the first name of the participant.</p> <p>In the Last Name field, type the last name of the participant.</p>
<p>Recording File Size</p>	<p>Select this attribute to specify a recording file size to be considered in the search.</p> <p>Available operators include: Equal to, Greater than, Greater than or equal to, Less than, Less than or equal to, or Not equal to.</p> <p>Type a numerical value for the argument in the value field.</p>
<p>Recording Length</p>	<p>Select this attribute to specify a recording length to be considered in the search.</p> <p>Available operators include: Equal to, Greater than, Greater than or equal to, Less than, Less than or equal to, or Not equal to.</p> <p>Enter a time value for the recording length in the value field.</p>
<p>Site ID</p>	<p>Include this attribute in your search for interactions to be retrieved based on Site ID.</p> <p>Available operators include: Equal to, Greater than, Greater than or equal to, Less than, Less than or equal to, or Not equal to.</p> <p>Type a numerical value for the argument in the value field.</p> <p>This simple attribute can contain sub-instances.</p> <p>Note: Screen Recordings are not returned on searches using this attribute, as screen recordings are not associated with Site IDs.</p>
<p>Wrap-up Code</p>	<p>Include this attribute in your search for interactions to be retrieved based on Wrap-up Codes.</p> <p>Available operands include: Contains, Does not contain, Equal to, Is empty, Is not empty, or Not equal to.</p> <p>Type a value for the argument in the value field.</p> <p>This simple attribute can contain sub-instances.</p> <p>Note: Screen Recordings are not returned on searches using this attribute, as screen recordings do not have wrap-up codes.</p>

	<p>User Name</p>	<p>Include this attribute in your search for interactions to be retrieved based on User Name.</p> <p>This is a simple attribute with two operators to choose from, Equal to and Not equal to.</p> <p>The value field is a drop-down list of User Names. You can use the drop-down list to select a User Name or you can begin typing a name to display available User Names to choose from.</p> <p>If duplicate Display Names are detected for the User Name, the IC User name value is appended to the Display Name. For example:</p> <p>John Smith (JSmith) John Smith (JASmith)</p> <p>If further duplicates are detected when there are users with the same Display Name and IC User name, a counter is appended to the end of the Display Name. For example:</p> <p>John Smith (JSmith) John Smith (JASmith) John Smith (JASmith) (1)</p> <p>This attribute can include sub-instances.</p>
<p>Media Specific > Calls</p>	<p>Call Type</p>	<p>Use this attribute to select recordings based on Call Type. The available Call Types are: Conference, External, Intercom, or Unknown.</p> <p>Note: The owner of an intercom recording is the person who is receiving the call.</p>
	<p>Participant Phone Number</p>	<p>Use this attribute to select recordings based on the participant phone number.</p> <p>Type the phone number for the argument in the value field.</p> <p>The available operators are: Equal to, Not equal to, Contains, or Does not contain.</p> <p>This attribute can include sub-instances.</p>
<p>Media Specific > E-mails</p>	<p>CC Importance Subject</p>	<p>Available e-mail attributes to consider in a search are:</p> <p>E-mail cc, to include a recipient's name who was copied on the e-mail. Operators include Contains, Does not contain, Equal to, Is empty, Is not empty, or Not equal to;</p> <p>E-mail Importance, options include High, Low, Normal, or Unknown; and</p> <p>E-mail Subject, operators include Contains, Does not contain, Equal to, Is empty, Is not empty, or Not equal to.</p>

<p>Media Specific > Social Conversation</p>	<p>Platform Channel Page</p>	<p>Social Conversation attributes are:</p> <p>Social Conversation Platform Use this attribute to select a social media platform from the list, such as Facebook or Twitter.</p> <p>Social Conversation Channel Use this attribute to enter a channel name, which has been predefined by your administrator.</p> <p>Social Conversation Page Use this attribute to enter a corporate Facebook page name. Twitter does not use Pages.</p>
<p>Media Specific > Social Direct Message</p>	<p>Platform Channel Page</p>	<p>Social Direct Message attributes are:</p> <p>Social Direct Message Platform Use this attribute to select a social media platform from the list, such as Facebook or Twitter.</p> <p>Social Direct Message Channel Use this attribute to enter a channel name, which has been predefined by your administrator.</p> <p>Social Direct Message Page Use this attribute to enter a corporate Facebook page name. Twitter does not use Pages.</p>
<hr/>		
<p>Questionnaires</p>	<p>Number of Finished Questionnaires</p>	<p>This simple attribute allows you to search by the number of finished questionnaires that have been scored against a recording.</p> <p>The following operators are available to choose from: Equal to, Greater than, Greater than or equal to, Less than, Less than or equal to, Not equal to.</p> <p>Type a numerical value for the argument in the value field.</p> <p>This attribute can include sub-instances.</p>
	<p>Number of Incomplete Scores</p>	<p>This simple attribute allows you to search by the number of incomplete scorecards associated with a recording.</p> <p>The following operators are available to choose from: Equal to, Greater than, Greater than or equal to, Less than, Less than or equal to, Not equal to.</p> <p>Type a numerical value for the argument in the value field.</p> <p>This attribute can include sub-instances.</p>
	<p>Questionnaire Name</p>	<p>This simple attribute allows you to search by the name of a questionnaire associated with a recording.</p> <p>There are two operators to choose from, Equal to and Not equal to.</p> <p>The value field is a drop-down list of available questionnaire names.</p> <p>This attribute can include sub-instances.</p>

<p>Ranking</p>	<p>This is a rich attribute. Use it to search by Rank Group and Rank Name. The options are available from drop-down lists.</p> <p>The Rank Name operators are: Contains, Does not contain, Equal to, Is empty, Is not empty, and Not equal to.</p> <p>After you have selected the Rank Group that you want to search for, the associated ranking is displayed in the Rank Name field. Select the Rank Name for your search.</p>
<p>Scorecard Has Signature Comments</p>	<p>Select this attribute to search for Scorecards based on Signature Comments.</p> <p>Select Yes to return scorecards in the search results that <i>have</i> signature comments.</p> <p>Select No to return scorecards in the search results that <i>do not</i> have any signature comments.</p>
<p>Scorecard Signature Status</p>	<p>Select this attribute to search for Scorecards based on the status of the signature.</p> <p>Select No signature required to return scorecards in the search that do not require a signature.</p> <p>Select Awaiting signature/Signature required to return scorecards in the search that require a signature but have not been signed.</p> <p>Select Signed to return scorecards in the search that have been signed.</p>
<p>Scored User</p>	<p>This attribute searches for users who have had questionnaires scored against their recordings.</p> <p>This is a simple attribute with two operators to choose from, Equal to and Not equal to.</p> <p>The value field is a drop-down list of user <code>displaynames</code>, if available, otherwise a <code>UserID</code> appears if a <code>displayname</code> is not available.</p> <p>This attribute can include sub-instances.</p>
<p>Scoring User</p>	<p>This attribute searches for users who have scored recordings.</p> <p>This is a simple attribute with two operators to choose from, Equal to and Not equal to.</p> <p>The value field is a drop-down list of user IDs.</p> <p>This attribute can include sub-instances.</p>
<p>Scoring Status</p>	<p>Use this attribute to search for recordings by their scoring status.</p> <p>The options are Assigned, Finished, or Saved.</p> <p>This attribute can include sub-instances.</p>

Survey	Survey Ranking	<p>This rich attribute allows you to search for a survey by Rank Group. The options are available from drop-down lists.</p> <p>After you have selected the Rank Group that you want to search for, the associated ranking is displayed in the Rank Name field. Select the Rank Name for your search.</p> <p>Available operators include: Contains, Does not contain, Equal to, Is empty, Is not empty, or Not equal to.</p>
	Survey Scored User	<p>This attribute allows you to search for a user that has been scored in a survey.</p> <p>This is a simple attribute with two operators to choose from, Equal to and Not equal to. The drop-down list allows you to select a user name for your search.</p> <p>This attribute can include sub-instances.</p>
	Survey Name	<p>This attribute allows you to search for a survey by Survey Name.</p> <p>This is a simple attribute with two operators to choose from, Equal to and Not equal to. The drop-down list allows you to select a survey name for your search.</p> <p>This attribute can include sub-instances.</p>
	Survey State	<p>This simple attribute allows you to search for surveys by Survey State.</p> <p>The operators are Equal to and Not equal to. The drop-down field list includes the following states of a survey to choose from: Abandoned, Caller disconnected, Complete, Error, Insufficient resources, Not answered, and Opt out.</p> <p>This attribute can include sub-instances.</p>
Advanced	Recording Attribute	<p>Use this rich attribute to search for recordings by a custom Recording Attribute.</p> <p>Select the name of the attribute from the drop-down list.</p> <p>Choose from the operators Contains, Does not contain, Equal to, Is empty, Is not empty, and Not equal to, and type the value in the field.</p> <p>If you leave the operator and value blank, all recordings that have this attribute will be returned regardless of the attribute's value.</p> <p>Custom Attributes Not Equal to and Does Not Contain searches find <i>all</i> recordings that do not have the attribute equal to the value.</p>

	<p>Recording File Name</p>	<p>This is a simple attribute that allows you to search for a recording by Recording File Name.</p> <p>Choose from the operators Contains, Does not contain, Equal to, Is empty, Is not empty, and Not equal to. Type the file name in the field.</p> <p>This attribute can include sub-instances.</p>
	<p>Recording ID</p>	<p>A Recording ID is a unique identifier for each recorded interaction. Recording IDs are only used by Interaction Recorder and are only visible when browsing recordings or in search results.</p> <p>This is a simple attribute that allows you to search for a recording by Recording ID.</p> <p>Choose from the operators Contains, Does not contain, Equal to, Is empty, Is not empty, and Not equal to. Type the Recording ID in the field.</p> <p>This attribute can include sub-instances.</p>
	<p>Recording is in Progress</p>	<p>Select this attribute to search for recordings that are in progress or recordings that are not in progress.</p> <p>Select Yes to return recordings in the search results that are in progress.</p> <p>Select No to return recordings in the search results that are not in progress.</p>
	<p>Recording is Encumbered</p>	<p>Select this attribute to search for recordings that are encumbered. Recordings are encumbered if the user or station was not properly licensed for Interaction Recorder when the recording was made.</p> <p>Select Yes to return recordings in the search results that are encumbered. When the search results are displayed, the user or station that is not properly licensed is displayed in the Local Party Name column.</p> <p>Select No to return recordings in the search results that are not encumbered.</p>
	<p>Recording Tag</p>	<p>Select this attribute to search for recordings based on a Recording Tag. Select an operator, and enter the Recording Tag name in the field. You can use the drop-down list to select a Recording Tag, or you can begin typing a name to display available Recording Tags to choose from.</p> <p>Available operators include: Contains, Does not contain, Equal to, Is empty, Is not empty, or Not equal to.</p>
	<p>Recording Type</p>	<p>Select this attribute to retrieve recordings based on the recording type. Select Policy-based for recordings that were created by an Initiation Policy, or select Snippet Recording for recordings that were created using the Snip recording option. Select an operator from the drop-down list. Available operators are Equals to and Not equal to.</p>

	<p>Survey ID</p>	<p>The Survey ID is a unique internal identifier for Interaction Feedback surveys. It is a 32 character hexadecimal number that is randomly generated when a survey is created. It is only viewable by administrators who have access to the database.</p> <p>This is a simple attribute that allows you to search for a recording by Survey ID.</p> <p>Choose from the operators Contains, Does not contain, Equal to, Is empty, Is not empty, and Not equal to. Type the Survey ID in the field.</p> <p>This attribute can include sub-instances.</p>
	<p>Has Been Archived</p>	<p>Select this attribute to search for recordings that have or have not been archived.</p> <p>Select Yes to return recordings in the search results that have been archived.</p> <p>Select No to return recordings in the search results that have not been archived.</p>

Scorecard Search

Scorecard searches are created in the workspace by selecting search attributes that are grouped into four main categories: Scorecard, Scores, Scored Participant, and Scoring Individual.

After you create a scorecard search, simply run the search. The search results are displayed in a graph or a grid in the Search Results view in the workspace. Scorecard search results are displayed initially in a pie chart.

In the Navigation pane, you can create Public and Private Searches. Scorecard searches are easily built in the workspace using the SearchBuilder control and selecting search attributes. Scorecard Search Attributes are grouped into four main categories:

- Scorecard
- Scores
- Scored Participant
- Scoring Individual

After adding an attribute to your search, use the SearchBuilder control to configure simple and rich attributes in the workspace.

Public Searches for Scorecards

Public searches can be seen and managed by all users on a server that have been assigned an Interaction Recorder Client Access license in Interaction Administrator.

Creating a Public Search for Scorecards

Public Searches that a user creates, for public sharing, are stored in **Public Searches**. Folders can be created to store searches or searches can be stored directly in the Public Searches folder.

Creating a folder to contain your scorecard search

To create a folder to contain your search:

1. In the Searches pane, select **Public Searches**.

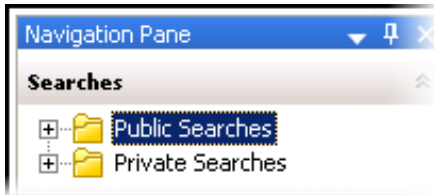

2. Right-click, and on the shortcut menu, point to **New**, and click **Folder**. A New Folder is selected under Public Searches.
3. Right-click the new folder and click **Rename**.
4. Type a name for the folder and click **Enter**.

Creating a search

To create a search to be stored in a folder:

1. Select the folder, right-click, and on the submenu point to **New** and click **Scorecard Search**. The Create Scorecard Search dialog is displayed in the workspace.

Note To create a search directly in the Public Searches folder, right-click on the **Public Searches** folder and follow the same steps.

2. To name your search, in the **Title** box type a name for your search.
3. In the **Max results** box, type the number for the maximum number of results to display. The default is 100.

Adding Attributes to a Scorecard Search

Use the SearchBuilder control to select attributes to add to your search. Simple and rich attributes can be added. Sub-instances can be added to a simple attribute, and rich attributes contain multiple sub-fields. First, add an attribute to your search.

To add an attribute to your search:

1. In the **New Attribute** drop-down list, point to the type of attribute you want to include. A submenu is displayed with a list of available attributes for the type you have selected.
2. In the submenu, click the attribute. The attribute control is added to the workspace.

For detailed information on attributes, see [Scorecard Search Attributes](#).

Configuring a simple attribute

A simple attribute contains an operator and a field value that can be a string, list, or numeric type value. To configure a simple attribute:

1. Select the operator.
2. Configure the values for the attribute.

Working with attributes

Attributes within the search are logically AND'd together. You can add in a UNION operator in-between attributes to logically OR them together. To do this, right-click in the workspace, and click **UNION Operator**.





Use the Up and Down buttons to prioritize the order in which the attributes and unions should be considered when running the search. These controls are also available on the right-click shortcut menu.



Use the Delete button to remove an attribute from the search. Delete is also available from the right-click shortcut menu.

Deleting sub-instances from a simple attribute

When more than one sub-instance is included in a simple attribute, the Delete More button  is available to the right of the active sub-instance, allowing you to delete the sub-instance. To do this:

1. In the search builder control on the workspace, in the attribute, select the sub-instance. The Delete More button  is displayed next to the sub-instance.
2. Click Delete More . The sub-instance is removed from the attribute.

Configuring a rich attribute

Rich attributes contain multiple sub-fields. Sub-fields are logically OR'd together within the search. To configure a rich attribute:

1. In the SearchBuilder control on the workspace, select the attribute. A highlighted selection rectangle appears around the attribute control to indicate it is the active attribute.
2. Depending on the type of rich attribute you selected, configure the operator values.
3. Use the Up and Down buttons  to prioritize the order in which the attributes and unions should be considered when running the search.

When all attributes have been configured for your search, click Create Search. The search is executed, the name of the search is displayed under the folder in the Navigation Pane, and the search results are displayed in the workspace. For more details, see [Run and View a Search](#).

Private Searches for Scorecards

Private searches can be built, viewed, configured, and run only by the owner of the search.

Creating a Private Search for Scorecards

Creating a folder to contain your scorecard search

To create a folder to contain your search:

1. In the **Searches** pane, select **Private Searches**.



2. Right-click, and on the shortcut menu, point to **New**, and click **Folder**. A **New Folder** is selected under Private Searches.
3. Right-click the new folder and click **Rename**.
4. Type a name for the folder and click **Enter**.

Creating a search

To create a search to be stored in a folder:

1. Select the folder, right-click, and on the submenu point to **New** and click **Scorecard Search**. The Create Scorecard Search dialog is displayed in the workspace.

Note To create a search directly in the Private Searches folder, right-click on the **Private Searches** folder and follow the same steps.

2. To name your search, in the **Title** box type a name for your search.
3. In the **Max results** box, type the number for the maximum number of results to display. The default is 100.

Adding Attributes to a Scorecard Search

Use the SearchBuilder control to select attributes to add to your search. Simple and rich attributes can be added. Sub-instances can be added to a simple attribute, and rich attributes contain multiple sub-fields. First, add an attribute to your search.

To add an attribute to your search:

1. In the **New Attribute** drop-down list, point to the type of attribute you want to include. A submenu is displayed with a list of available attributes for the type you have selected.
2. In the submenu, click the attribute. The attribute control is added to the workspace.

For detailed information on attributes, see [Scorecard Search Attributes](#).

Configuring a simple attribute

A simple attribute contains an operator and a field value that can be a string, list, or numeric type value. To configure a simple attribute:

1. Select the operator.
2. Configure the values for the attribute.

Working with attributes

Attributes within the search are logically AND'd together. You can add in a UNION operator in-between attributes. To do this, right-click in the workspace, and click **UNION Operator**.





Use the Up and Down buttons to prioritize the order in which the attributes and unions should be considered when running the search. These controls are also available on the right-click shortcut menu.



Use the Delete button to remove an attribute from the search. Delete is also available from the right-click shortcut menu.

Adding sub-instances to a simple attribute

When a simple attribute has been added to the workspace, the Add More button  is displayed in the upper right corner of the attribute control. To add an additional sub-instance of the attribute:



1. First, in the SearchBuilder control on the workspace, select the attribute. A highlighted selection rectangle appears around the attribute control to indicate it is the active attribute, and the Add More  button is displayed.
2. Click Add More . The attribute sub-instance is nested within the parent control, with an additional operator and field value control.

Note

After you have added the number of sub-instances allowed by the attribute, the  is no longer displayed as an option. For example, Scoring Status has three available attributes, Assigned, Scoring incomplete, and Finished. After two sub-instances have been added to the original attribute, the Add More icon is no longer displayed.

Deleting sub-instances from a simple attribute

When more than one sub-instance is included in a simple attribute, the Delete More button  is available to the right of the active sub-instance, allowing you to delete the sub-instance. To do this:

1. In the SearchBuilder control on the workspace, in the attribute, select the sub-instance. The Delete More button  is displayed next to the sub-instance.
2. Click Delete More . The sub-instance is removed from the attribute.

Configuring a rich attribute

Rich attributes contain multiple sub-fields. Sub-fields are logically OR'd together within the search. To configure a rich attribute:

1. In the SearchBuilder control on the workspace, select the attribute. A highlighted selection rectangle appears around the attribute control to indicate it is the active attribute.
2. Depending on the type of rich attribute you selected, configure the operator values.
3. Use the Up and Down buttons  to prioritize the order in which the attributes and unions should be considered when running the search.

When all attributes have been configured for your search, click Create Search. The search is executed, the name of the search is displayed under the folder in the Navigation Pane, and the search results are displayed in the workspace. For more details, see [Run and View a Search](#).

Add Attributes to a Scorecard Search

After you have created a Public or Private search, use the SearchBuilder control, displayed in the workspace, to add and configure attributes in your search.

Adding Attributes to a Scorecard Search

To display SearchBuilder in the workspace, select a search in the Searches pane. The search is displayed in the workspace, and the SearchBuilder is displayed with the **New Attribute** drop-down list.

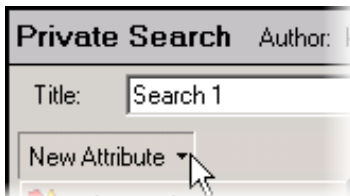

When you click **New Attribute**, the following types of scorecard attributes are displayed:

- Scorecard
- Scores
- Scored Participant
- Scoring Individual

To select an attribute, point to the type of attribute you want to add to your search, and the available attributes are displayed in a submenu. Simple and rich attributes can be added to your search. Sub-instances can be added to a simple attribute, and rich attributes contain multiple sub-fields.

For detailed information on attributes, see [Scorecard Search Attributes](#).

Adding Attributes to a Search

Use the SearchBuilder control to select attributes to add to your search. To add an attribute to a search:

1. In the **New Attribute** drop-down list, point to the type of attribute you want to include. A submenu is displayed with a list of available attributes for the type you have selected.
2. In the submenu, click the attribute. The attribute control is added to the workspace.

An attribute might be a simple attribute or a rich attribute. A simple attribute contains an operator and a field value that can be a string, list, or numeric type value. A rich attribute contains multiple sub-fields.

To configure a simple attribute:

1. In the SearchBuilder control on the workspace, select the attribute. A highlighted selection rectangle appears around the attribute control to indicate it is the active attribute.
2. Select the operator for the attribute
3. Configure the values for the attribute

To configure a rich attribute:

1. In the SearchBuilder control on the workspace, select the attribute. A highlighted selection rectangle appears around the attribute control to indicate it is the active attribute.
2. Depending on the type of rich attribute you selected, configure the operator values.

Attributes within the search are logically AND'd together. You can add in a UNION operator in-between attributes. To do this, right-click in the workspace, and click **UNION Operator**.

Arranging attributes within a search attribute



Use the Up and Down buttons to prioritize the order in which the attributes and unions should be considered when running the search. These controls are also available on the right-click shortcut menu.



Deleting an attribute from the search



Use the Delete button to remove an attribute from the search. Delete is also available from the right-click shortcut menu.

Adding sub-instances to a simple attribute

When a simple attribute has been added to the workspace, the Add More button  is displayed in the upper right corner of the attribute control. To add an additional sub-instance of the attribute:



1. First, in the SearchBuilder control on the workspace, select the attribute. A highlighted selection rectangle appears around the attribute control to indicate it is the active attribute, and the Add More  button is displayed.
2. Click Add More . The attribute sub-instance is nested within the parent control, with an additional operator and field value control.

Note

After you have added the number of sub-instances allowed by the attribute, the  is no longer displayed as an option. For example, **Direction** has four available attributes: Inbound, Intercom, Outbound, and Unknown. After three sub-instances have been added to the original attribute, the Add More icon is no longer displayed.

Deleting sub-instances from a simple attribute

When more than one sub-instance is included in a simple attribute, the Delete More button  is available to the right of the active sub-instance, allowing you to delete the sub-instance. To do this:

1. In the SearchBuilder control on the workspace, in the attribute, select the sub-instance. The Delete More button  is displayed next to the sub-instance.
2. Click Delete More . The sub-instance is removed from the attribute.

Scorecard Search Attributes

The information in the following table describes the available Scorecard Search attributes that are used to create scorecard searches. These attributes are available in the search builder control when a scorecard search is displayed in the workspace.

The Scorecard Search Attributes are defined by the following types:

- Scorecard
- Scores
- Scored Participant
- Scoring Individual

Attribute Type	Attribute	Description
Scorecard	Marked for Calibration	<p>Select this attribute to search for scorecards that have been marked for calibration.</p> <p>Select Yes to return scorecards in the search results that have been marked for calibration.</p> <p>Select No to return scorecards in the search results that have not been marked for calibration.</p> <p>The Marked for Calibration attribute can include a sub-instance.</p> <p>Note</p> <p>Calibration provides confidence that monitored interactions will be scored consistently among Quality Assurance team members. Calibrating scoring ensures fairness to agents whose recorded interactions are being evaluated.</p> <p>When a questionnaire is marked for Calibration, the score is excluded from other scored interactions and does not count toward the agent's performance results. Questionnaires marked for Calibration are also excluded from the overall group performance results.</p> <p>When creating a Scorecard Search in IC Business Manager, you can search for Scorecards Marked for Calibration, to include them in your search results.</p> <p>Calibration reports, in Interaction Reporter, are based on the results of completed evaluations marked for Calibration.</p>
	Questionnaire	<p>Include this attribute in your search for scorecards to be retrieved based on Questionnaire names.</p> <p>This is a simple attribute with two operators to choose from, Equal to and Not equal to.</p> <p>The value field is a drop-down list of Questionnaire names. Use the drop-down list to select a Questionnaire name.</p> <p>This attribute can include sub-instances.</p>
	Recording ID	<p>A Recording ID is a unique identifier for each recorded interaction. Recording IDs are only used by Interaction Recorder and are only visible when browsing recordings or in search results.</p> <p>This is a simple attribute that allows you to search for a Scorecard by Recording ID.</p> <p>Choose from the operators Equal to, Not equal to, Contains, Does not contain, Is empty, and Is not empty.</p> <p>This attribute can include sub-instances.</p>

	Scorecard Rank	<p>Include this attribute in your search for scorecards to be retrieved based on Scorecard rank.</p> <p>Choose from the operators Equal to, Not equal to, Contains, Does not contain, Is empty, and Is not empty.</p> <p>The value field is a drop-down list of Scorecard ranks. Use the drop-down list to select a Scorecard rank.</p> <p>If you want to search for a rank string that is not yet available in the list, manually enter a scorecard rank in the value field.</p> <p>This attribute can include sub-instances.</p>
	Scoring Date/Time	<p>Scoring Date/Time is a rich attribute that contains multiple sub-fields. You can select: Specify a date/time range, Specify a date period, or Specify shift date/time period. Operands are displayed depending on your selection.</p> <p>For Specify a date/time range, specify a date argument using the drop-down box and selecting a date from the calendar. Type or select a time to specify a time argument.</p> <p>For Specify a date period, specify a date in which the interactions occurred to be included in the search: Today, Last week, Last month, Last N hours, or Last N days.</p> <p>For Specify shift date/time period, specify a shift date range and time of day range. For example, a shift date/time might be Monday through Friday, 8:00 a.m. to 5:00 p.m.</p> <p>This attribute uses the Windows time zone set for the Windows User on the Interaction Recorder Client machine.</p> <p>Note: The Scoring Date/Time attribute retrieves scorecards based on the last scoring date/time stamp. This stamp is the last time a scorecard was changed and saved to the database.</p>
	Scoring Status	<p>Select this attribute to search for Scorecards based on the scoring status Assigned, Scoring incomplete, or Finished.</p> <p>The Scoring Status attribute can include sub-instances.</p>
	Has Signature Comments	<p>Select this attribute to search for Scorecards based on Signature Comments.</p> <p>Select Yes to return scorecards in the search results that have signature comments.</p> <p>Select No to return scorecards in the search results that do not have any signature comments.</p>
	Signature Status	<p>Select this attribute to search for Scorecards based on the status of the signature.</p> <p>Select No signature required to return scorecards in the search that do not require a signature.</p> <p>Select Awaiting signature/Signature required to return scorecards in the search that require a signature but have not been signed.</p> <p>Select Signed to return scorecards in the search that have been signed.</p>
Scores	Critical Score	<p>The Critical Score attribute searches for scorecards by Critical Score percentage.</p> <p>Available operators for Critical Score (percentage) include Equal to, Not equal to, Greater than, Greater than or equal to, Less than, and Less than or equal to.</p> <p>In the value field, enter a percentage from 0.00 to 100.00.</p> <p>Critical Score is a simple attribute that can contain sub-instances.</p>
	Non-critical Score	<p>The Non-critical Score attribute searches for scorecards by Non-critical Score percentage.</p> <p>Available operators for Non-critical Score (percentage) include Equal to, Not equal to, Greater than, Greater than or equal to, Less than, and Less than or equal to.</p> <p>In the value field, enter a percentage from 0.00 to 100.00.</p> <p>Non-critical Score is a simple attribute that can contain sub-instances.</p>

	Total Score	<p>The Total Score attribute searches for scorecards by Total Score percentage.</p> <p>Available operators for Total Score (percentage) include Equal to, Not equal to, Greater than, Greater than or equal to, Less than, and Less than or equal to.</p> <p>In the value field, enter a percentage from 0.00 to 100.00.</p> <p>Total Score is a simple attribute that can contain sub-instances.</p>
Scored Participant	Role	<p>Use a Role in your Scored Role search to return scorecards for scored participants who are assigned to this Role.</p> <p>In the value field, select a Role from the drop-down list to include in your search.</p> <p>Scored Role is a simple attribute that can contain sub-instances.</p> <p>Note: The Scored Role attribute is based on the current configuration of an IC user's Role. The Scored Role attribute is not a historical lookup of a scored participant's role at the time the scorecard was scored. For example, if a user was in the Agent role at the time a scorecard was scored and is now in the Supervisor role, a search of scorecards using the Scored Role attribute set to Agent would not return any of this user's scorecards. You could only search for scorecards where this user was scored in the current Role, Supervisor.</p>
	User	<p>Select a User for your Scored User search to return scorecards for specific Scored Participants.</p> <p>Available operators include: Equal to, Not equal to, Is empty, and Is not empty.</p> <p>In the value field, select a User from the drop-down list to include in your search.</p> <p>If duplicate Display Names are detected for the User Name, the IC User name value is appended to the Display Name. For example: John Smith (JSmith) John Smith (JASmith)</p> <p>If further duplicates are detected when there are users with the same Display Name and IC User name, a counter is appended to the end of the Display Name. For example: John Smith (JSmith) John Smith (JASmith) John Smith (JASmith) (1)</p> <p>Scored User is a simple attribute that can contain sub-instances.</p>
	Workgroup	<p>Use a Workgroup in your search, which is a defined logical group of Users related by function, department, project, or other organization and used for ACD call processing queues.</p> <p>In the value field, select an available Scored Workgroup from the drop-down list to include in your search.</p> <p>The list of available workgroups is filtered by the workgroup access rights the user has when logging on to IC Business Manager.</p> <p>Note: The Scored Workgroup attribute is based on the current configuration of an IC user's Workgroup. The Scored Workgroup attribute is not a historical lookup of a scored participant's workgroup at the time the scorecard was scored. For example, if a user was in the Support workgroup at the time a scorecard was scored and is now in the Sales workgroup, a search of scorecards using the Scored Workgroup attribute set to Support would not return any of this user's scorecards. You could only search for scorecards where this user was scored in the current Workgroup,Sales.</p>
Scoring Individual	Role	<p>Use a Role in your Scoring Role search to return scorecards for scoring individuals who are assigned to this Role.</p> <p>In the value field, select a Role from the drop-down list to include in your search.</p> <p>Scoring Role is a simple attribute that can contain sub-instances.</p> <p>Note: The Scoring Role attribute is based on the current configuration of an IC user's Role. The Scoring Role attribute is not a historical lookup of a scoring participant's role at the time the scorecard was scored. For example, if a user was in the Agent role at the time a scorecard was scored and is now in the Supervisor role, a search of scorecards using the Scoring Role attribute set to Agent would not return any of this user's scorecards. You could only search for scorecards where this user was scoring in the current Role, Supervisor.</p>

User	<p>Select a User for your Scoring User search to return scorecards for specific Scoring Users.</p> <p>Available operators include: Equal to, Not equal to, Is empty, and Is not empty.</p> <p>In the value field, select a User from the drop-down list to include in your search.</p> <p>If duplicate Display Names are detected for the User Name, the IC User name value is appended to the Display Name. For example: John Smith (JSmith) John Smith (JASmith)</p> <p>If further duplicates are detected when there are users with the same Display Name and IC User name, a counter is appended to the end of the Display Name. For example: John Smith (JSmith) John Smith (JASmith) John Smith (JASmith) (1)</p> <p>Scoring User is a simple attribute that can contain sub-instances.</p>
Workgroup	<p>Use a Workgroup in your search, which is a defined logical group of Users related by function, department, project, or other organization and used for ACD call processing queues.</p> <p>In the value field, select an available Scoring Workgroup from the drop-down list to include in your search.</p> <p>The list of available workgroups is filtered by the workgroup access rights the user has when logging on to IC Business Manager.</p> <p>Note: The Scoring Workgroup attribute is based on the current configuration of an IC user's Workgroup. The Scoring Workgroup attribute is not a historical lookup of a scoring participant's workgroup at the time the scorecard was scored. For example, if a user was in the Support workgroup at the time a scorecard was scored and is now in the Sales workgroup, a search of scorecards using the Scoring Workgroup attribute set to Support would not return any of this user's scorecards. You could only search for scorecards where this user was scoring in the current Workgroup, Sales.</p>

Run and View a Search

There are two types of searches: **Recording Searches** and **Scorecard Searches**.

- Recording searches display a list of recorded interactions for the configured search.
- Scorecard searches display search results in a graph or a grid in the Search Results.

Search results are displayed in a tabbed view in the workspace.

Run a Recording Search

When the recording Search Results are displayed in the workspace, specific details of recorded interactions can be reviewed in this view.

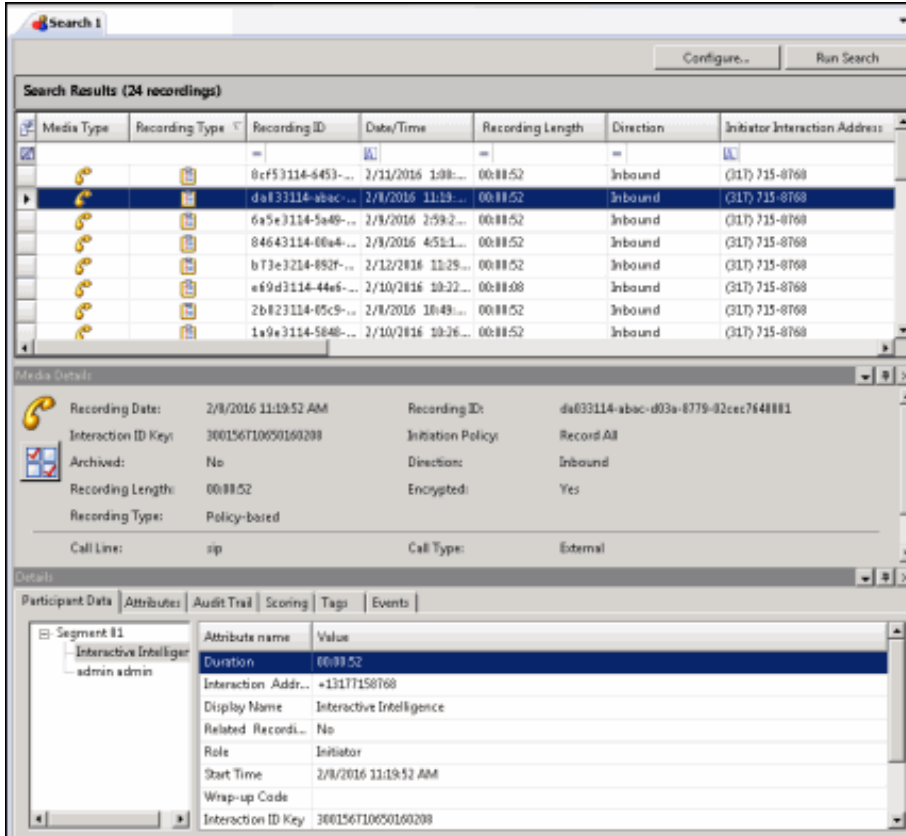

The screenshot shows a 'Search 1' window with 'Search Results (24 recordings)'. The table below lists the results:

Media Type	Recording Type	Recording ID	Date/Time	Recording Length	Direction	Initiator Interaction Address
		8cf53114-6453...	2/11/2016 1:08:...	00:01:52	Inbound	(317) 715-8768
		da033114-abac...	2/8/2016 11:19:...	00:01:52	Inbound	(317) 715-8768
		6a5e3114-5a49...	2/8/2016 2:59:2...	00:01:52	Inbound	(317) 715-8768
		84643114-00a4...	2/8/2016 4:51:1...	00:01:52	Inbound	(317) 715-8768
		b73e3214-892f...	2/12/2016 11:29...	00:01:52	Inbound	(317) 715-8768
		e69d3114-44e6...	2/10/2016 10:22...	00:01:08	Inbound	(317) 715-8768
		2b823114-05c9...	2/8/2016 10:49...	00:01:52	Inbound	(317) 715-8768
		1a9e3114-5848...	2/10/2016 10:26...	00:01:52	Inbound	(317) 715-8768

Below the table is the 'Media Details' section for the selected recording:

Recording Date:	2/8/2016 11:19:52 AM	Recording ID:	da033114-abac-d03a-8779-02cec7640881
Interaction ID Key:	300156710050160208	Initiation Policy:	Record All
Archived:	No	Direction:	Inbound
Recording Length:	00:01:52	Encrypted:	Yes
Recording Type:	Policy-based		
Call Line:	sip	Call Type:	External

The 'Details' section shows 'Participant Data' for 'Segment #1' with the following attributes:

Attribute name	Value
Duration	00:01:52
Interaction Addr...	+13177158768
Display Name	Interactive Intelligence
Related Record...	No
Role	Initiator
Start Time	2/8/2016 11:19:52 AM
Wrap-up Code	
Interaction ID Key	300156710050160208

Run a recording search from the Navigation Pane. To run a recording search:

1. From the **Navigation Pane**, in the **Searches** pane, select a recording search.

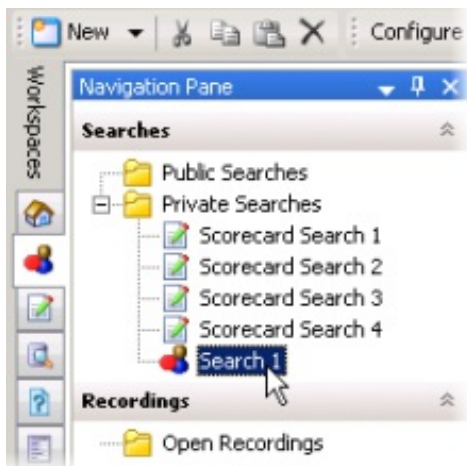

2. The search is automatically executed and the results are displayed in the workspace.

Note Here are other ways to run a search:

- From the **Searches** pane, select a search, and in the workspace click **Run Search**
- Select the search in the Searches pane, and on the menu bar click the **Search Title** Active View menu, and then click **Run Search**
- From the **Searches** pane, select a search, and click **Run Search** on the toolbar
- Select a search in the Searches pane, right-click, and on the shortcut menu, click **Run**

Save a Recording Search

Public and Private searches are automatically saved when they are run. If an invalid attribute field value is detected when running your search, an error message is displayed. Attribute data values are verified before a Search is run, and must contain valid data in order for the search to be saved.

When configuring a search in the SearchBuilder control, a search can be saved before running it by clicking **Save Search**. Using the Save Search button allows you to verify and save search attributes while building a search, before running it.

Edit a Recording Search

Edit a search to modify existing attributes or configure new search attributes. Here are different ways you can edit the search configuration:

- From the **Searches** pane, right-click on the search name, and on the shortcut menu click **Configure**. The properties of the search are displayed in the SearchBuilder control. For more information, see [Adding Attributes to a Recording Search](#).
- From the **Searches** pane, click the search name. The search is run and the results are displayed in the Workspace. On the Workspace, click **Configure**. The SearchBuilder control is displayed.
- You can also edit a search by selecting the search name in the Searches pane and clicking **Configure Search** on the toolbar.

Important Note

If you migrated Interaction Recorder from 3.0 to 2015 R1 or later, issues might have occurred with Searches during the migration process. As a result, a Migration Notes control might be displayed in a Search Configuration view. For more information, see [Appendix B: Search Configuration Migration Notes Control](#).

View Recording Search Results

Based on the attributes of the recording search, when a search is run, the results are displayed in the Search Results view in the workspace. A list of recorded interactions is displayed at the top of the workspace in a grid, which gives details of the interaction.

Use the Search Results view to review the details of an interaction and to playback a recording. Information on recordings is displayed in the **Media Details** and **Details** dockable panes, which are initially displayed at the middle and bottom of the workspace.

Search Results (14 recordings)

Media Type	Recording Type	Recording ID	Date/Time	Expiration Date	Recording Le	Direction	S
		4f727615-17b4-...	1/3/2019 4:00:08 PM	4/3/2019 5:00:08 PM	00:00:21	Inbound	
		30727615-b5ef-...	1/3/2019 3:57:56 PM	4/3/2019 4:57:56 PM	00:00:05	Outbound	
		30727615-8ea0-...	1/3/2019 3:57:55 PM	4/3/2019 4:57:55 PM	00:00:12	Outbound	

Media Details

Recording Date:	1/3/2019 3:57:56 PM	Recording ID:	30727615-b5ef-d0a6-8110-e981bed10001
Expiration Date:	4/3/2019 4:57:56 PM	Initiation Policy:	
Interaction ID Key:	100185172130190103	Direction:	Outbound
Archived:	No	Encrypted:	No
Recording Length:	00:00:05	Snippet Initiator:	user1 user1
Recording Type:	Snippet Recording	Call Type:	External

Details

Participant Data

Attributes

Audit Trail

Scoring

Tags

Events

Attribute name	Value
Wrap-up Code	
Interaction Addr...	/10001
Duration	00:00:11
Start Time	1/3/2019 3:57:55 PM
Interaction ID Key	100185172130190103
Role	Initiator
Disconnect Type	Local Disconnect
Display Name	user1 user1 (Interactive Intelligence)

Work with Recording Search Results

When a recording search is run, the results are displayed in the Search Results view in the workspace. A list of recorded interactions is displayed in a grid, which gives details of the recording. Use the Search Results view to review the details of an interaction, playback a recording, delete a recording, export a recording, modify a recording expiration date, or archive a recording. The Search results view contains the Recordings grid, the Media Details pane, and the Details pane.

The screenshot displays the IC Business Manager - Interaction Recorder interface. The main window shows a search results grid with 48 recordings. The grid columns include Media Type, Recording Type, Recording ID, Date/Time, Recording Length, Direction, Initiator Interaction Address, and Interaction Address. The selected recording (Recording ID: ceb54e15-976...) has its details expanded in the Media Details pane. Below this, the Details pane shows participant data for Segment 01 (XYZ Corp user1 user1).

Media Type	Recording Type	Recording ID	Date/Time	Recording Length	Direction	Initiator Interaction Address	Interaction Address
		08b64e15-b97...	8/27/2018 6:11...	00:00:05	Intercom	10001	10002
		3aad4e15-2e1...	8/27/2018 3:29...	00:00:46	Inbound	WFO Team Account D	workgroup1
		ceb54e15-976...	8/27/2018 6:07...	00:03:00	Inbound	XYZ Corp	workgroup1
		fcae4e15-6b2...	8/27/2018 4:02...	00:00:10	Inbound	Jhh Genesys	workgroup1
		73cc4d15-594...	8/24/2018 6:50...	00:02:43	Inbound	WFO Team Account D	workgroup1
		7dd24d15-ecb...	8/24/2018 8:41...	00:00:29	Inbound	XYZ Corp	workgroup1
		6ad04d15-7af...	8/24/2018 8:45...	00:01:08	Inbound	XYZ Corp	workgroup1

Recording Date:	Recording ID:
11/26/2018 9:52:34 AM	33b46a15-6e24-d0d4-82d6-c20e8e6bc
Expiration Date:	Initiation Policy:
(no expiration)	New Policy
Interaction ID Key:	Direction:
300116860250181126	Intercom
Archived:	Encrypted:
No	No
Recording Length:	Recording Type:
00:00:15	Policy-based
Recording Type:	Call Type:
Policy-based	Intercom

Participant Data	Attributes	Audit Trail	Scoring	Tags	Events
Segment 01 XYZ Corp user1 user1	Attribute name	Value			
	Duration	00:02:59			
	Interaction Addr...	XYZ Corp			
	Display Name	XYZ Corp			
	Role	Initiator			
	Start Time	8/27/2018 6:07:01 AM			

Recordings grid

The results of a recording search are displayed in the grid at the top of the workspace. The grid displays a list of recordings, by Date/Time that are found for the search, in descending order (newest to oldest).

Search Results (14 recordings)								
Media Type	Recording Type	Recording ID	Date/Time	Expiration Date	Recording Le	Direction	Scor	
		4f727615-17b4-...	1/3/2019 4:00:08 PM	4/3/2019 5:00:08 PM	00:00:21	Inbound		
		30727615-b5ef-...	1/3/2019 3:57:56 PM	4/3/2019 4:57:56 PM	00:00:05	Outbound		
		30727615-8ea0-...	1/3/2019 3:57:55 PM	4/3/2019 4:57:55 PM	00:00:12	Outbound		
		23727615-f1e9-...	1/3/2019 3:57:00 PM	4/3/2019 4:57:00 PM	00:00:52	Outbound		
		11727615-1dda-...	1/3/2019 3:55:43 PM	4/3/2019 4:55:43 PM	00:00:19			
		0e727615-d3d0-...	1/3/2019 3:55:30 PM	4/3/2019 4:55:30 PM	00:00:39	Outbound		
		05727615-260c-...	1/3/2019 3:54:48 PM	4/3/2019 4:54:48 PM	00:00:11	Intercom		
		01727615-a8f7-...	1/3/2019 3:54:34 PM	4/3/2019 4:54:34 PM	00:00:24	Outbound		
		f4717615-e426-...	1/3/2019 3:53:35 PM	4/3/2019 4:53:35 PM	00:00:25	Outbound		

Notes

- To paste recording information into another application, use Ctrl+C in the recordings grid to Copy an entire row, or multiple rows, to the clipboard.
- When there is more than one scorecard associated with a recording, the **Scoring Status** column displays the scorecard at the highest level of completion. For example, if a recording has two scorecards and one of the scorecards is **Completed** and the other is **Saved**, the Scoring Status column displays Completed and the Scoring User column displays the user name for the owner of the Completed scorecard. If there is more than one scorecard at the highest level of completion, the Scoring User column displays the user who is alphabetically first by last name.
- The Scoring User column displays the names of the users that scored the individual recordings displayed in the Search Results grid. If the user, viewing the Search Results, has the **Can Score Recordings** Security Policy rights for a recording, the Scoring User name is displayed in the Scoring User column. If the user does *not* have the **Can Score Recordings** policy rights for the recording, the recording is not displayed in the search results.
- If a recording is in progress, the value in the **Recording Length** field is blank in the search results grid.
- If a call recording is in progress when the recording is opened, the Playback window is replaced with the message **This recording is currently in progress and cannot be retrieved at this time**. You can monitor a recording in process. For more information, see [Monitor a Live Call](#).

Selecting Fields for the grid



To change the Fields for the columns that are displayed in the grid, click the **Field Chooser** on the upper left of the grid. The Show/Hide Columns dialog is displayed.

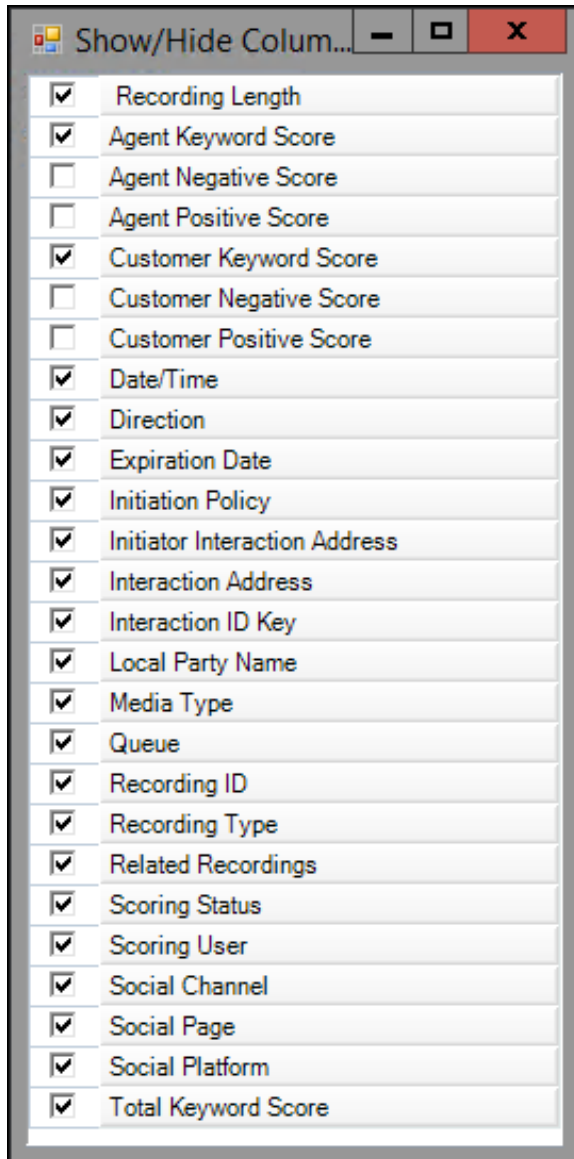

In the **Show/Hide Columns** dialog select the Fields to display in the grid.



Sorting columns in the grid

To sort a grid column in ascending or descending order, click the Field name.

Refining search results

To further refine the search results, use the Filter Criteria selection fields  below each Field. To create a field filter for the search results displayed in the grid, select the field below the Field name. The field search filter is displayed. To select an operand for the search, click . In the drop-down list, select the search criteria. Depending on the field and your selections, an additional dialog might be displayed. The search results are displayed according to your search filter. To clear the filter criteria, in the field click .

To clear *all* filter criteria, click  at the left on the Filter Criteria selection fields grid row.

Recording Details

When you select a recording in the Search results list, detailed information on a recording is displayed in **Media Details** and **Details** panes. These panes are displayed at the bottom of the workspace and can be moved and docked to another location on your screen.

Open a Recording

To Open a Recording, double-click a recording in the Search Results grid. You can also right-click on a recording, and on the shortcut menu click **Open Recording**. The recording opens in the playback dialog, and the recording is listed in the Open Recordings folder in the Navigation Pane.

Media Details pane

When you select an interaction in the search results grid, details of the interaction are displayed in the **Media Details** pane. The details include: Recording Date, Recording ID, Expiration Date, Initiation Policy, Interaction ID Key, Direction, Archived indicator, Encrypted indicator, Recording Length, Recording Type, and other specific details depending on the type of interaction, call, email, chat, or social media recording. The Media Details pane also includes an Assign Calibration button to mark a recording for calibration.



To undock the Media Details pane from the workspace, double-click the title bar. The Media Details pane moves from the workspace. To move the Media Details pane to another place on your screen, click the title bar and drag the window.

To dock the Media Details back in the workspace, right-click, and on the shortcut menu, click **Floating** to clear the check box.

To hide the Media Details pane in the workspace, right-click on the title bar, and in the shortcut menu click **Auto Hide**. A tabbed page is displayed at the bottom of the workspace. Click the tab to display the **Media Details** view.

Details pane

The Details pane displays additional interaction details for the selected interaction. The Details pane includes the following tabbed pages:

- Participant Data
- Attributes
- Audit Trail
- Scoring
- Tags
- Events

For complete descriptions of the Details pane tabbed pages, see [Details Pane](#).

If Interaction Analyzer Keywords are associated with an interaction, a **Keywords** tab is also displayed.

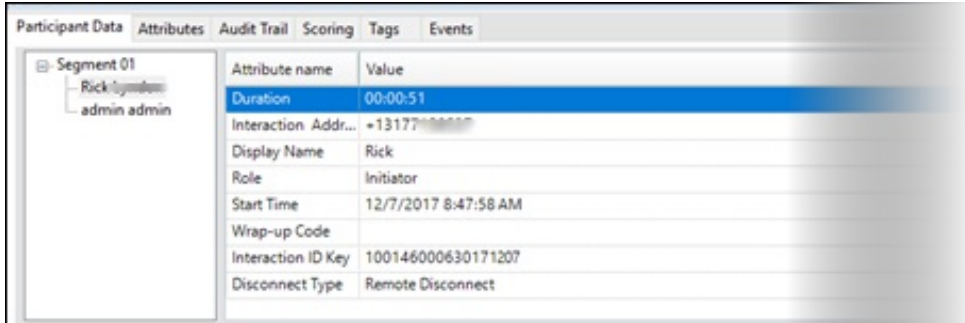

To undock the Details pane from the workspace, double-click the title bar. The Details pane moves from the workspace. To move the Details pane to another place on your screen, click the title bar and drag the window.

To dock the Details back in the workspace, right-click, and on the shortcut menu, click **Floating** to clear the check box.

To hide the Details pane in the workspace, right-click on the title bar, and on the shortcut menu, click **Auto Hide**. A tabbed page is displayed at the bottom of the workspace. Click the tab to display the **Details** view.

Scoring page

Use the Scoring page in the Details pane to access a Questionnaire and Score a recording. Questionnaires that have previously been assigned to a recording are displayed on the Scoring page. Additional Questionnaires can be assigned to the recording on the Scoring page. Only questionnaires that have been published are available for scoring.

User Scorecard Access

Non-admin users only see Questionnaire scorecards that they have scored. To allow users to see all scorecards for a recording, the CIC Administrator can create a Security Policy so a user **can view scorecards**. This Security Policy can be applied to Agents or Roles. Questionnaire Directory Admin Access and other security rights will still apply. For non-admin users, in order to finish a scorecard that has already been scored by another user, the user must first save the scorecard to take ownership and then the user can finish the scorecard.

Assigning a Questionnaire

To assign a questionnaire, click **Assign Questionnaire**, and select a questionnaire from the **Select Questionnaire** dialog.

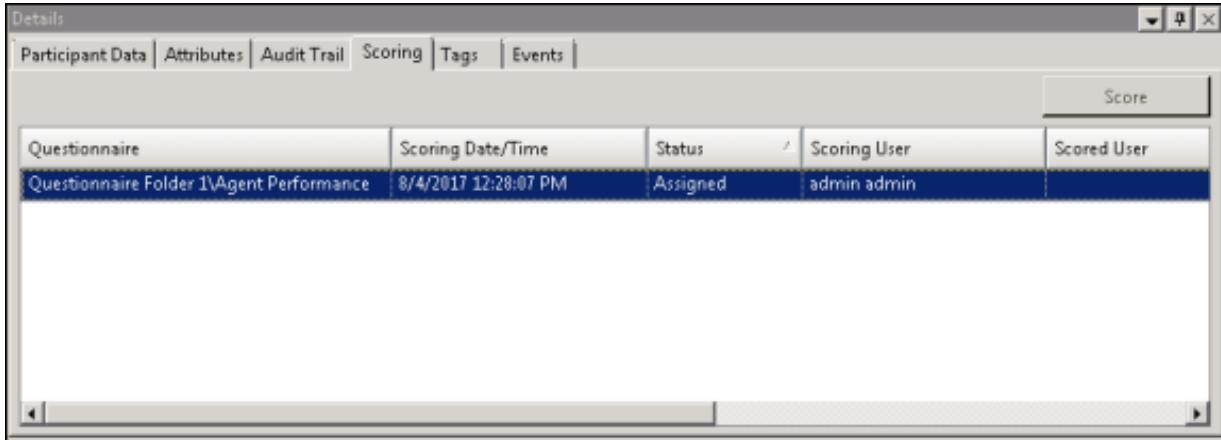

The screenshot shows a 'Details' window with several tabs: Participant Data, Attributes, Audit Trail, Scoring, Tags, and Events. The 'Scoring' tab is active. A 'Score' button is located in the top right corner. Below the tabs is a table with the following data:

Questionnaire	Scoring Date/Time	Status	Scoring User	Scored User
Questionnaire Folder 1\Agent Performance	8/4/2017 12:28:07 PM	Assigned	admin admin	

Note To assign a questionnaire to a recording you must have the **Can Assign Questionnaires** security right, assigned in Policy Editor.

When you click **Assign Questionnaire** the **Select Questionnaire** dialog is displayed.

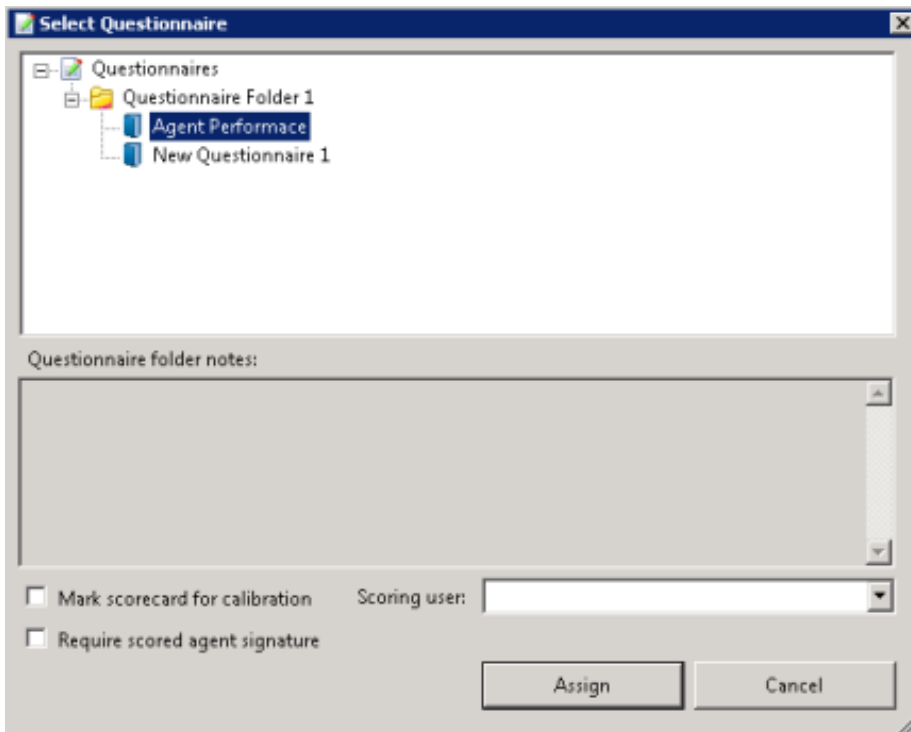

To assign a user to score the recording, select the **Scoring user** from the drop-down list. To select the completed scorecard for calibration purposes, select the **Mark scorecard for calibration** check box. To require an agent signature on the completed scorecard, select the **Require scored agent signature** check box.

To score a recording, on the Scoring page, click **Score**. The Questionnaire to score the recording is displayed and the media player is launched displaying details of the recording.

Tags page

The Tags page displays Tags for a recording that were created in Policy Editor and assigned to a recording.

Tags can be added and edited in the Playback window Details pane on the Tags page. If the Details pane is not showing, in the Playback window right-click, and on the shortcut menu point to **Show** and click **Details**.

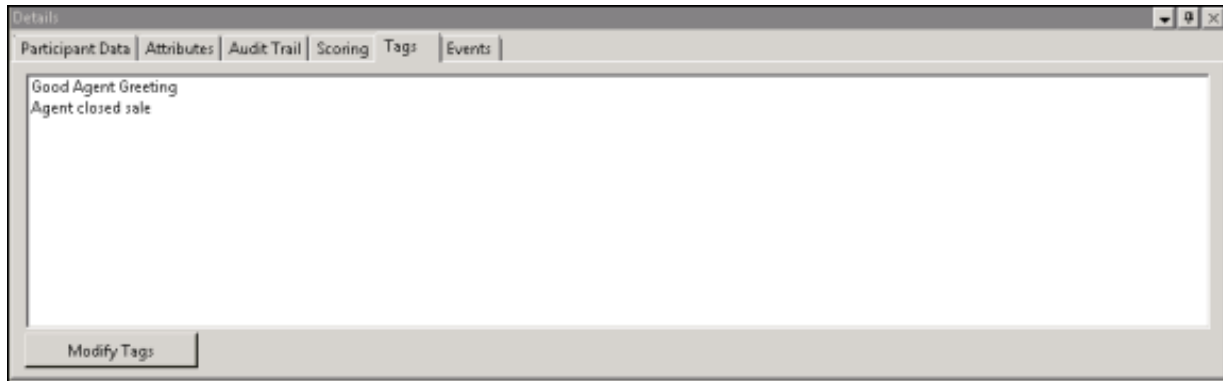

To add and edit Tags, click **Modify Tags** to open the Playback window. The Playback window is displayed.

Note

Adding or removing a Tag in Interaction Recorder client in IC Business Manager creates an audit entry for the recording. The audit trail entry for the change contains comments that describe the change. These comments can be viewed on **Audit Trail** page in the Details pane.

Events page

The Events page displays the Hold Event information. This tab is displayed for each recording if the user has sufficient security and access rights to be able to retrieve or playback the recording.

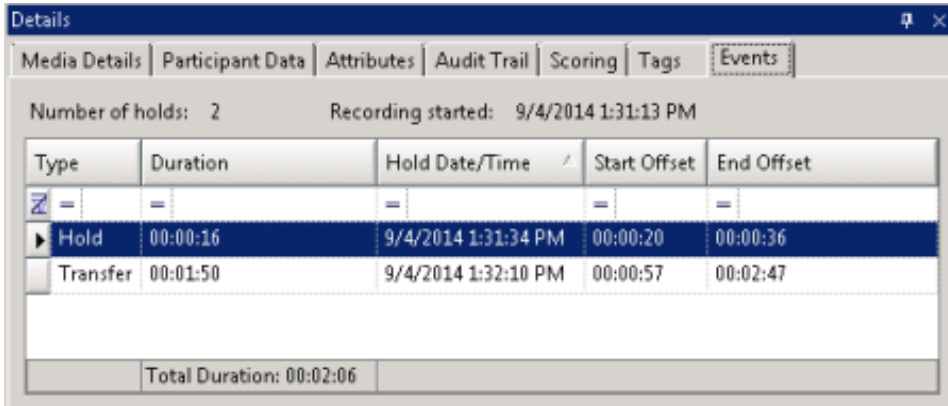

Type	Duration	Hold Date/Time	Start Offset	End Offset
Hold	00:00:16	9/4/2014 1:31:34 PM	00:00:20	00:00:36
Transfer	00:01:50	9/4/2014 1:32:10 PM	00:00:57	00:02:47
Total Duration:				00:02:06

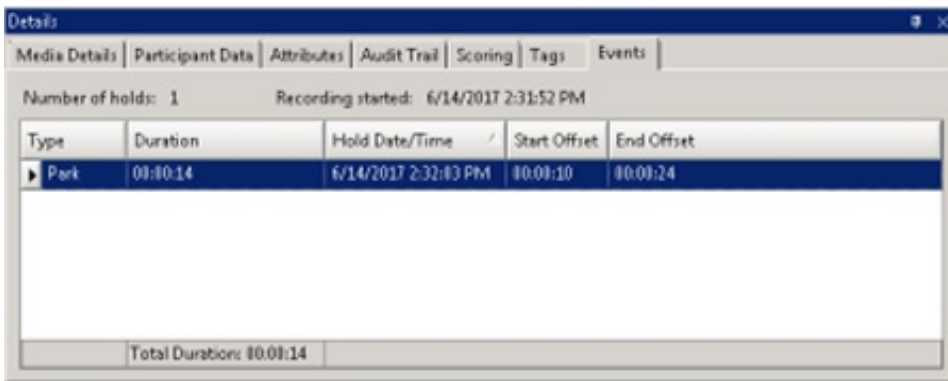

Type	Duration	Hold Date/Time	Start Offset	End Offset
Park	00:00:14	6/14/2017 2:32:03 PM	00:00:10	00:00:24
Total Duration:				00:00:14

By default, the rows on the Events page are sorted in ascending order by the Start/Date/Time value. The columns displayed on the Events page are:

- **Type**This value indicates the type of Hold event that occurred within the recording. Valid Hold display values are: **Hold**, **Transfer**, and **Park**.
- **Duration**This value indicates the length of the Hold, rounded to the nearest second. The summary row for this column displays the total duration of the Holds (summed before any rounding) for this recording, and is rounded to the nearest second.
- **Hold Date/Time**This value displays when the Hold began in local Date/Time. The summary row for this column displays the total number of Holds that occurred for this recording.
- **Start Offset**This value displays when the Hold began as an offset from the beginning of the recording, rounded to the nearest second.
- **End Offset**This value displays when the Hold ended as an offset from the beginning of the recording, rounded to the nearest second.

Note: If the duration for a Hold event is less than .5 seconds and greater than zero (0) seconds, the Event Duration states less than 1 second.

Media Details Pane

The Media Details pane is displayed in the Search results view in the workspace.

The screenshot displays the IC Business Manager - Interaction Recorder application. The main window shows a search results table with 48 recordings. The selected recording is highlighted in blue. Below the table, the Media Details pane is visible, showing various attributes of the selected recording. The Details pane includes tabs for Participant Data, Attributes, Audit Trail, Scoring, Tags, and Events. The Attributes tab is currently selected, showing a list of attributes and their values.

Media Type	Recording Type	Recording ID	Date/Time	Recording Length	Direction	Initiator Interaction Address	Interaction Address
		08b64e15-b97...	8/27/2018 6:11...	00:00:05	Intercom	10001	10002
		3aa04e15-2e1...	8/27/2018 3:29...	00:00:46	Inbound	WFO Team Account D	workgroup1
		c6b54e15-976...	8/27/2018 6:07...	00:03:00	Inbound	XYZ Corp	workgroup1
		fc0e4e15-6b2...	8/27/2018 4:03...	00:00:10	Inbound	Jsh Genesys	workgroup1
		73cc4d15-594...	8/24/2018 6:50...	00:02:43	Inbound	WFO Team Account D	workgroup1
		76d24d15-ec0...	8/24/2018 8:41...	00:00:29	Inbound	XYZ Corp	workgroup1
		4ad04d15-7af...	8/24/2018 8:45...	00:01:08	Inbound	XYZ Corp	workgroup1

Media Details

Recording Date:	11/26/2018 9:52:34 AM	Recording ID:	33b46a15-6e24-d0d4-82d6-c20e8e6bc
Expiration Date:	(no expiration)	Initiation Policy:	New Policy
Interaction ID Key:	300116860250181126	Direction:	Intercom
Archived:	No	Encrypted:	No
Recording Length:	00:00:15		
Recording Type:	Policy-based	Call Type:	Intercom

Details

Participant Data	Attributes	Audit Trail	Scoring	Tags	Events
Segment 01 XYZ Corp user1 user1	Attribute name	Value			
	Duration	00:02:59			
	Interaction Addr...	XYZ Corp			
	Display Name	XYZ Corp			
	Role	Initiator			
	Start Time	8/27/2018 6:07:01 AM			

When an interaction is selected, details of the recorded interaction are displayed in the **Media Details** pane. The details include:

- Recording Date
- Recording ID
- Expiration Date
- Initiation Policy
- Interaction ID Key
- Direction
- Archived indicator
- Encrypted indicator
- Recording Length
- Recording Type
- Snippet Initiator
- Media Type details

Assign Calibration Scorecards

The Media Details pane also includes an Assign Calibration button to assign calibration scorecards to a recording.



To assign calibration scorecards for a recording, click the Assign Calibration button . The Assign Calibration Scorecards dialog is displayed.

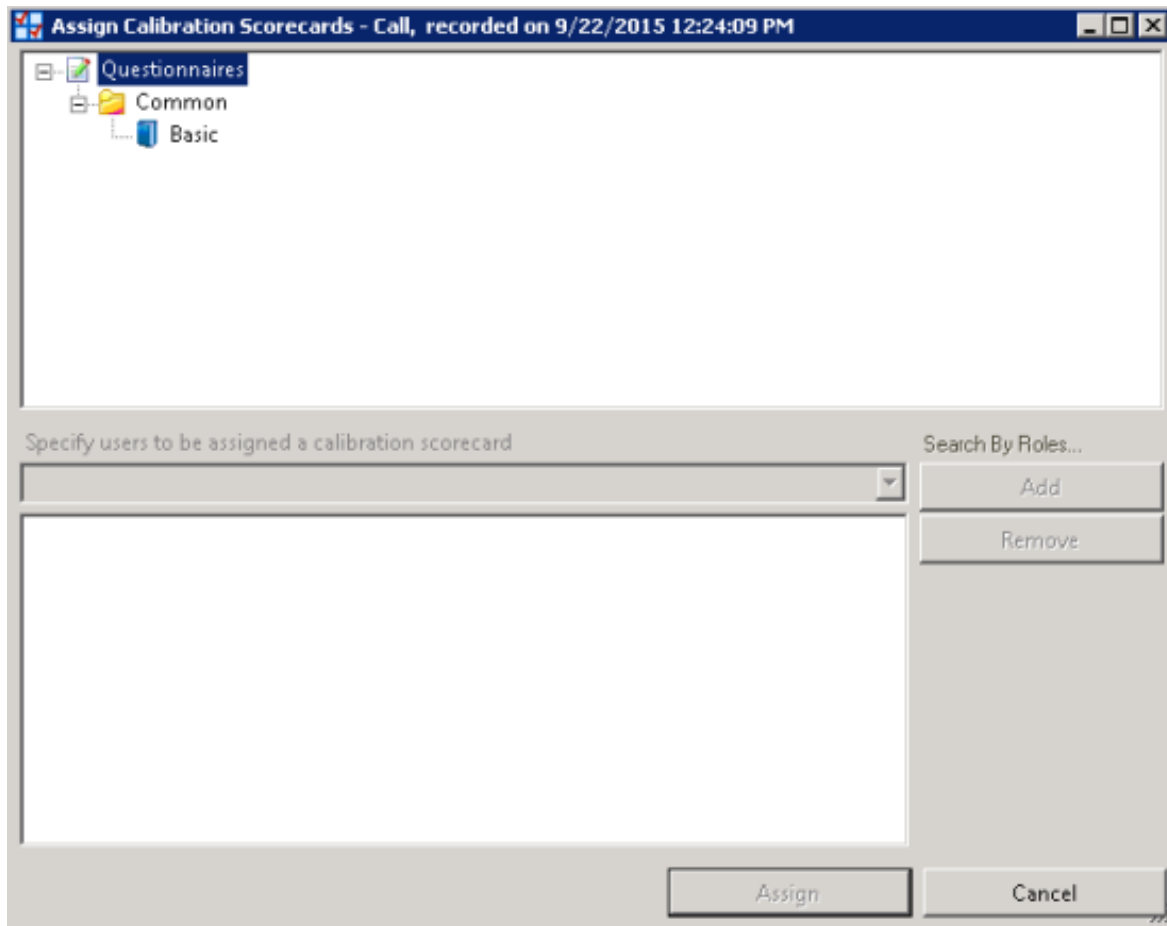

Use the Assign Calibration Scorecards dialog to assign a questionnaire to the recording and to specify the scoring users to be assigned the calibration scorecard.

To assign a questionnaire to be used for calibration:

1. Select a questionnaire from a Questionnaires folder.
2. From the drop-down list specify the scoring users to be assigned the calibration scorecard.

You can also specify users by Roles. To do this:

- a. Click **Search By Roles**. The Search by Roles dialog is displayed.

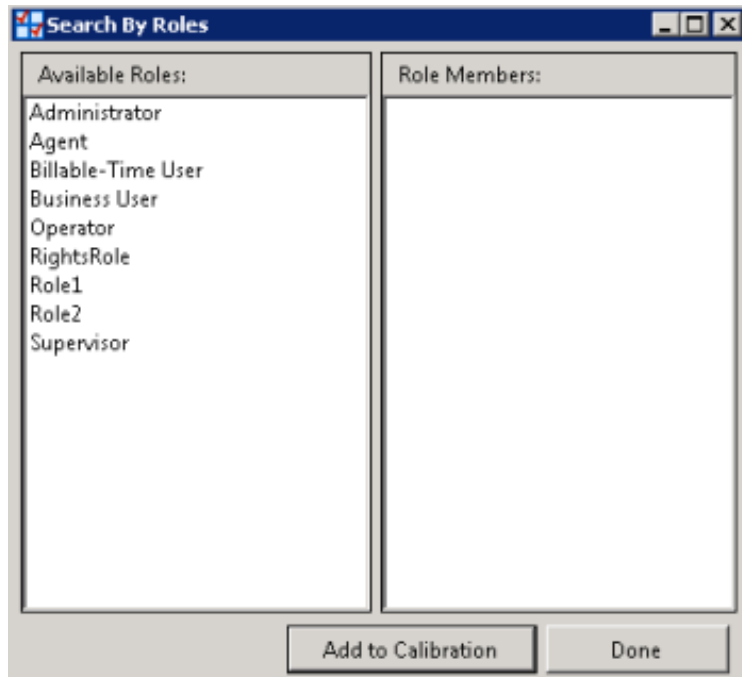

- b. Select a Role to display its members.
 - c. Select users from the Role Members.
 - d. Click **Add to Calibration** to include the names in the calibrate recording user list in the Assign Calibration Scorecards dialog.
 - e. When you have finished adding Role Members, click **Done**.
3. When you have finished specifying users to be assigned the calibration scorecard, click **Assign**.

Moving the Media Details pane

You can undock the Media Details pane from the workspace and move it to another location on your screen. To undock the Media Details pane, double-click the title bar. The Media Details pane moves from the workspace. To move the Media Details pane to another place on your screen, click the title bar and drag the window.

To dock the Media Details pane back in the workspace, double-click the title bar. The Media Details pane docks back in the workspace.

Hiding the Media Details pane

There are two ways to Hide the Media Details pane, Hide and Auto Hide. When you Hide the Media Details pane, it does not appear in the workspace. When you Auto Hide the Media Details pane, a tabbed page is displayed at the bottom of the workspace. Auto Hide allows you to display a pop-up pane, leaving more workspace for the Search results view.

To Hide the Media Details pane, right-click on the title bar, and on the shortcut menu, click **Hide**. To display the Media Details pane again, right-click in the workspace and on the shortcut menu point to **Show** and click **Media Details**. The Media Details pane is displayed in the workspace.

To Auto Hide the Media Details pane, right-click on the title bar, and on the shortcut menu, click **Auto Hide**. A tabbed page is displayed at the bottom of the workspace. To display the Media Details pane again, click the tab, and the Media Details pane pops up in the workspace. To turn Auto Hide off, when the pane is displayed, right-click the title bar and click **Auto Hide**. The Media Details pane is displayed in the workspace.

Details Pane

The Details pane is displayed in the Search Results View in the workspace.

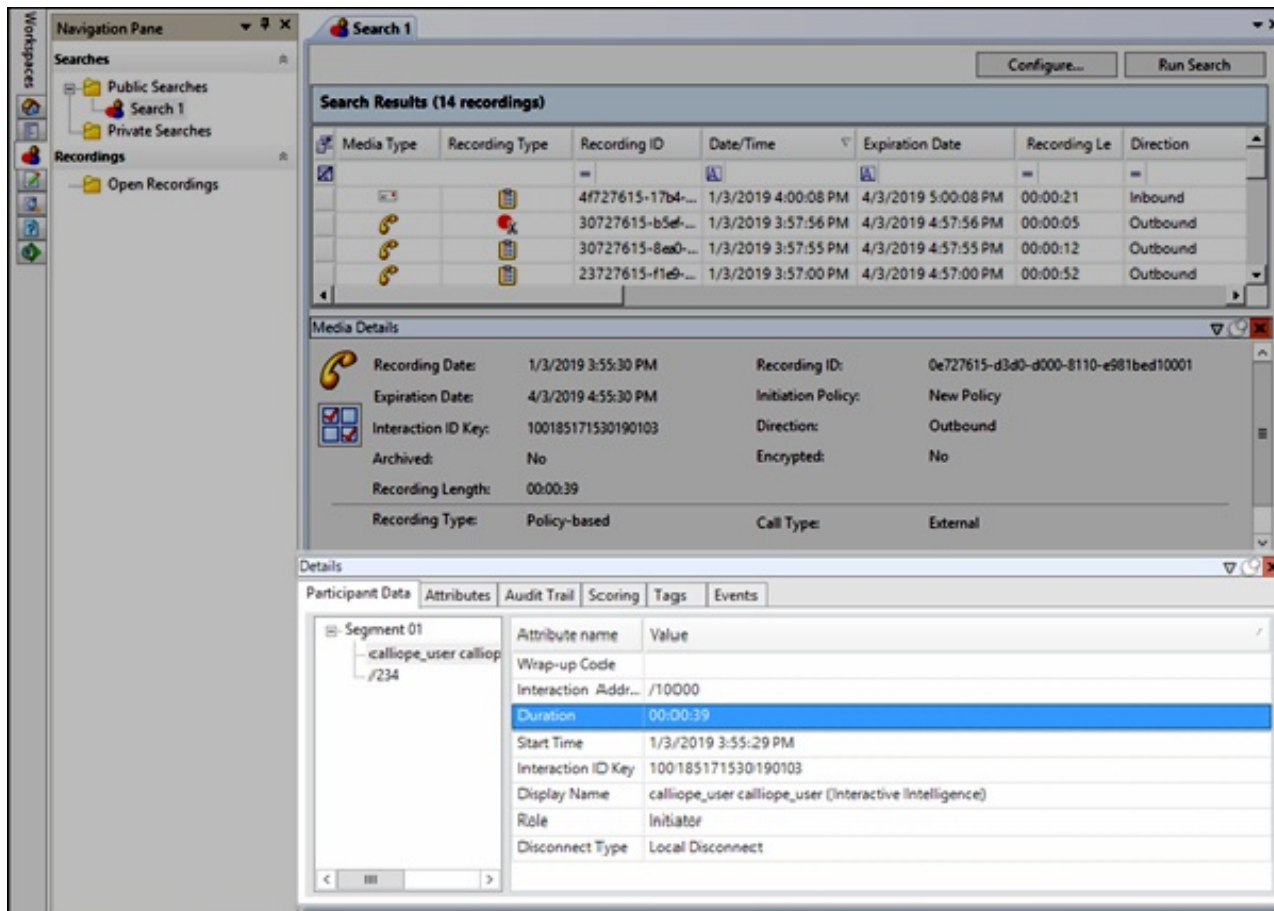

When an interaction is selected, additional interaction details are displayed in the **Details** pane. The Details pane includes the following tabbed pages:

- Participant Data
- Attributes
- Audit Trail
- Scoring
- Tags
- Events

Note:

If Interaction Analyzer Keywords are associated with an interaction, a Keywords tabbed page is also displayed.

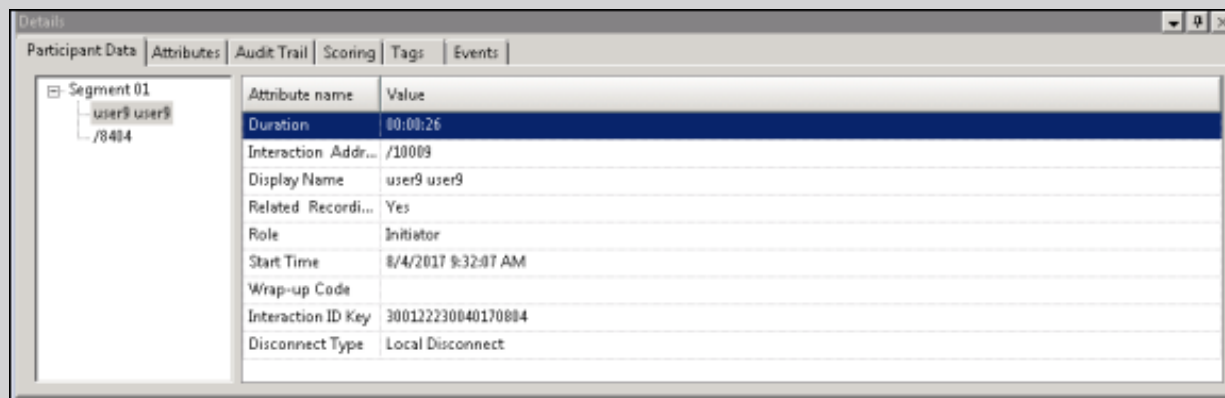

Participant Data page

The Participant Data page displays information on the parties of the selected interaction. The page displays Attributes and Values for the interaction participants.

Attributes page

The Attributes page displays the defined custom attributes that apply to this interaction.

The Attribute value field supports displaying multiple lines with the value text string. You can modify the value for the custom attribute. Only the Value can be modified; you cannot change the Attribute name on this page. The special characters comma (,) and equal sign (=) can be used when modifying the value. When modifying the Value, press Enter to add a new line to the attribute value string.

To end the edit mode and save the changes, click the pencil icon in the row selector.

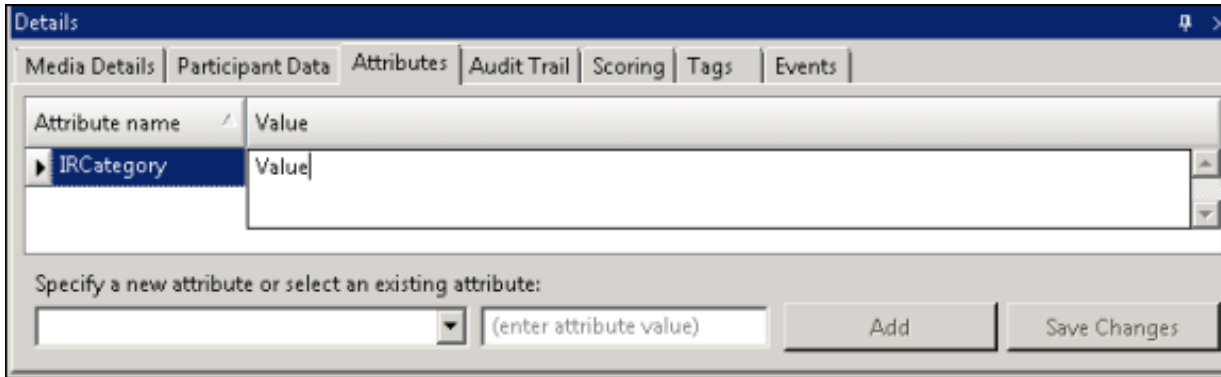

Note Adding or removing a Custom Attribute in Interaction Recorder client in ICBusiness Manager creates an audit entry for the recording. The audit trail entry for the change contains comments that describe the change.

Audit Trail page

The Audit Trail page displays information on audit events. The information includes: Date/Time, Audit Event, User, and Comments on the event. Use the shortcut menu from the Audit Trail page to refresh the audit trail data.

Scoring page

The Scoring page is used to access a Questionnaire and Score a recording. Questionnaires that have previously been assigned to a recording are displayed on the Scoring page. Additional Questionnaires can be assigned to the recording on this page. Only questionnaires that have been published are available for scoring.

Notes

- Non-admin users only see Questionnaire scorecards that they have scored. To allow users to see all scorecards for a recording, the CIC Administrator can create a Security Policy so a user can **view scorecards**. This Security Policy can be applied to Agents or Roles. Questionnaire Directory Admin Access and other security rights will still apply. For non-admin users, in order to finish a scorecard that has already been scored by another user, the user must first save the scorecard to take ownership and then the user can finish the scorecard.

- The Scoring User column displays the names of the users that scored the recording selected in the Search Results grid. If the user, viewing the Search results, has the **Can Score Recordings** Security Policy rights for the selected recording, the Scoring User name is displayed in the Scoring User column. If the user does *not* have the **Can Score Recordings** policy rights for the recording, the recording is not displayed in the search results.

To assign a questionnaire, click **Assign Questionnaire**, and select a questionnaire from the **Select Questionnaire** dialog.

Questionnaire	Scoring Date/Time	Status	Scoring User	Scored User
Questionnaire Folder 1\Agent Performance	8/4/2017 12:28:07 PM	Assigned	admin admin	

Note

To assign a questionnaire to a recording you must have the **Can Assign Questionnaires** security right, assigned in Policy Editor.

When you click **Assign Questionnaire** the **Select Questionnaire** dialog is displayed.

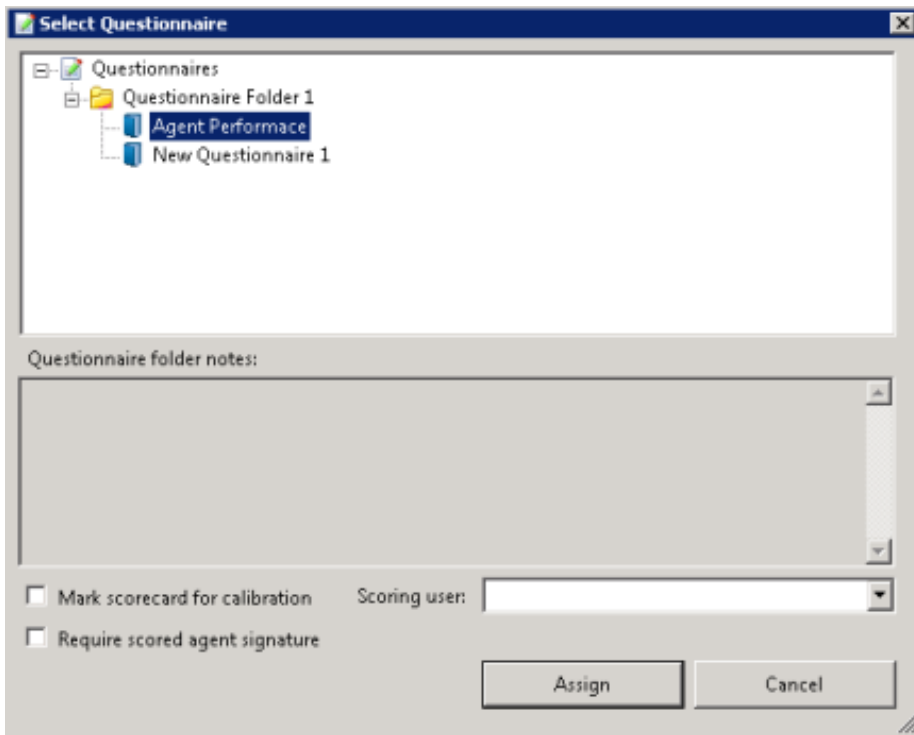

To assign a user to score the recording, select the **Scoring user** from the drop-down list. To select the completed scorecard for calibration purposes, select the **Mark scorecard for calibration** check box. To require an agent signature on the completed scorecard, select the **Require scored agent signature** check box.

To score a recording, on the Scoring page, click **Score**. The Questionnaire to score the recording is displayed and the media player is launched displaying details of the recording.

You can also right-click on a Questionnaire, and on the shortcut menu, click **Score**.

The Questionnaire to score the recording is displayed and the media player is launched displaying details of the recording.

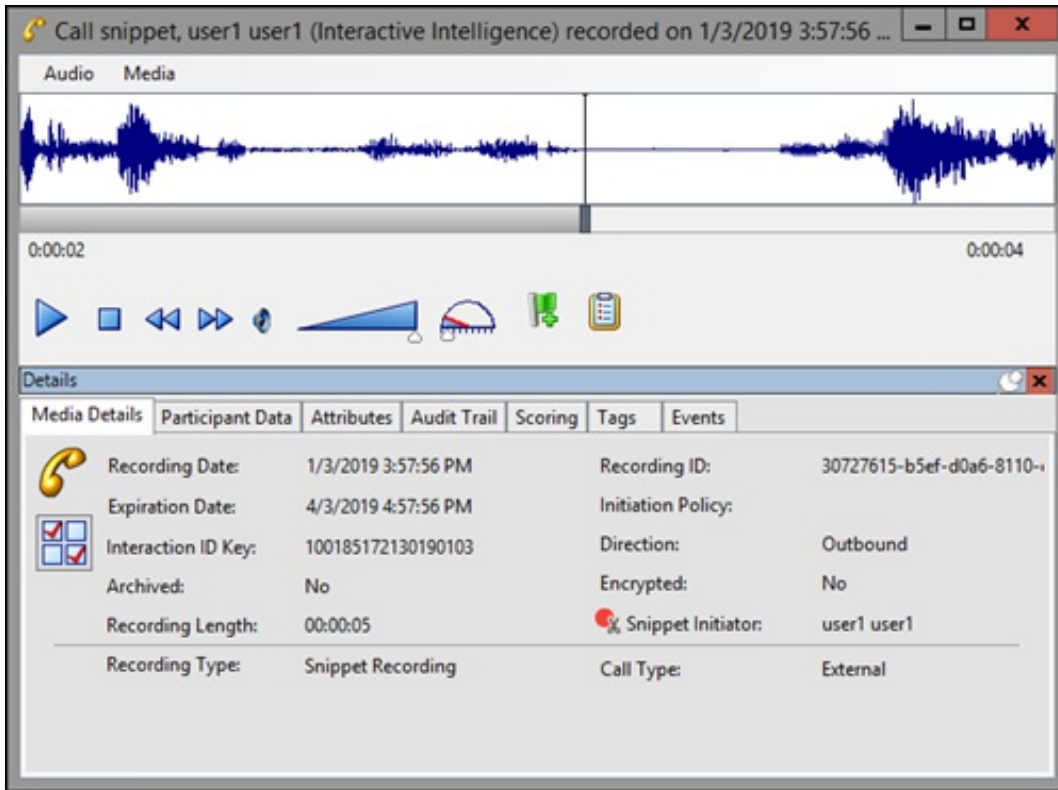

Playback forms vary according to the Media Type.

A Quality Scorecard Report can be generated from the Scoring page in the Details pane. To generate a report, on the Scoring page select a Questionnaire. Right-click, and on the shortcut menu, click **Run Report**. For more information on Quality Scorecard Reports, see [Quality Scorecard Report](#).

Tags page

The Tags page displays Tags for a recording that were created in Policy Editor and assigned to a recording.

Tags can be added and edited in the Playback window Details pane on the Tags page. If the Details pane is not showing, in the Playback window right-click, and on the shortcut menu point to **Show** and click **Details**.



To add and edit Tags, click **Modify Tags** to open the Playback window. The Playback window is displayed.

Note

Adding or removing a Tag in Interaction Recorder client in IC Business Manager creates an audit entry for the recording. The audit trail entry for the change contains comments that describe the change. These comments can be viewed on **Audit Trail** page in the Details pane.

Keywords page

Keywords and phrases spotted by Interaction Analyzer are stored along with recordings, allowing for rapid searching of recordings for playback. Policy Editor Initiation Policies determine which call interactions are analyzed for keywords and phrases.

If Interaction Analyzer Keywords are associated with an interaction, a Keywords page is available.

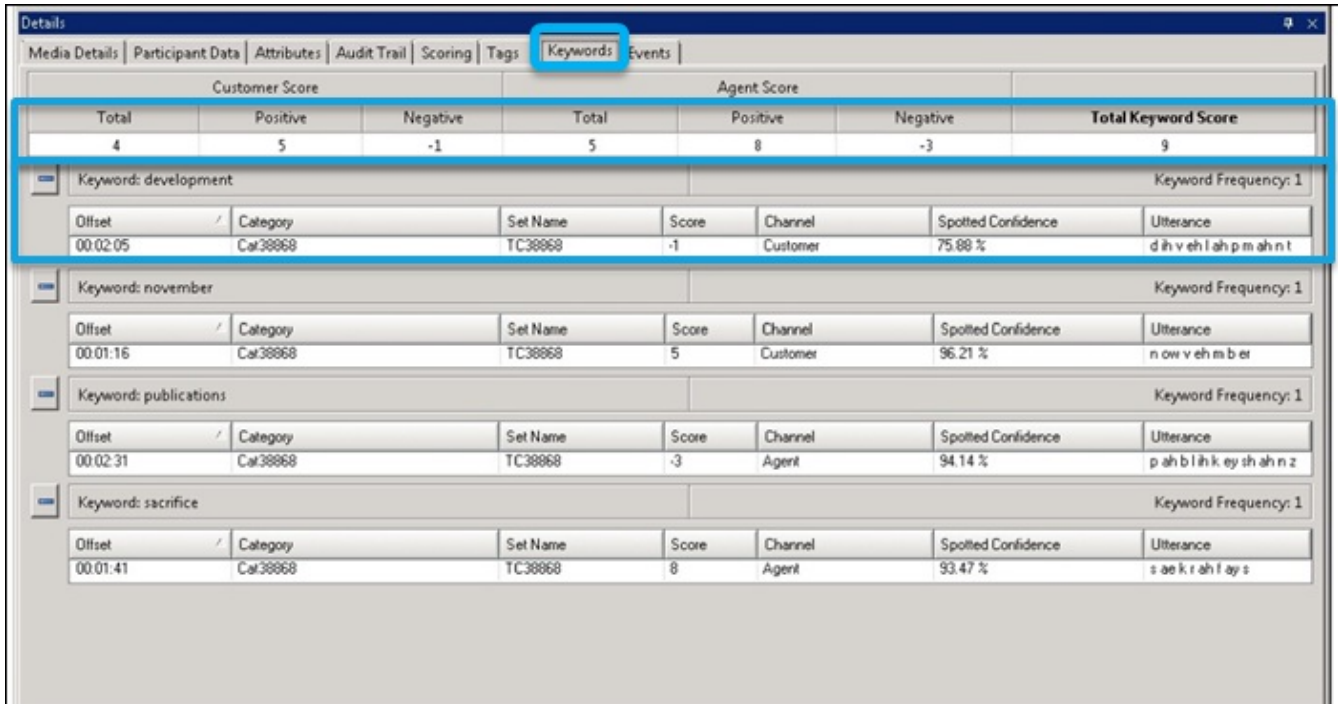

Customer Score			Agent Score			Total Keyword Score
Total	Positive	Negative	Total	Positive	Negative	
4	5	-1	5	8	-3	9

Keyword: development							Keyword Frequency: 1
Offset	Category	Set Name	Score	Channel	Spotted Confidence	Utterance	
00:02:05	Cal38868	TC38868	-1	Customer	75.88 %	d ĩ h v eh l ah p m ah n t	

Keyword: november							Keyword Frequency: 1
Offset	Category	Set Name	Score	Channel	Spotted Confidence	Utterance	
00:01:16	Cal38868	TC38868	5	Customer	96.21 %	n ow v eh m b er	

Keyword: publications							Keyword Frequency: 1
Offset	Category	Set Name	Score	Channel	Spotted Confidence	Utterance	
00:02:31	Cal38868	TC38868	-3	Agent	94.14 %	p ah b l ĩ h k ey sh ah n z	

Keyword: sacrifice							Keyword Frequency: 1
Offset	Category	Set Name	Score	Channel	Spotted Confidence	Utterance	
00:01:41	Cal38868	TC38868	8	Agent	93.47 %	s ae k r ah l ay s	

The Analyzer results information displayed on the Keywords page includes:

- Customer Scores
- Agent Scores
- Total Keyword Score
- Keyword name
- Offset (time point in call of Keyword hit)
- Category
- Set Name
- Keyword Score
- Channel (Agent or Customer)
- Spotted confidence
- Utterance

Note

The Spotted Confidence value displayed is rounded to 2 decimal places. The tooltip for Spotted Confidence displays the value up to 4 decimal places.

For information on setting the score of a keyword or phrase, see the *Interaction Analyzer Technical Reference* in the PureConnect Documentation Library.

Events page

The Events page displays the Hold Event information. This tab is displayed for each recording if the user has sufficient security and access rights to be able to retrieve or playback the recording.

Type	Duration	Hold Date/Time	Start Offset	End Offset
Hold	00:00:16	9/4/2014 1:31:34 PM	00:00:20	00:00:36
Transfer	00:01:50	9/4/2014 1:32:10 PM	00:00:57	00:02:47
Total Duration: 00:02:06				

Type	Duration	Hold Date/Time	Start Offset	End Offset
Park	00:01:14	6/14/2017 2:32:03 PM	00:00:10	00:01:24
Total Duration: 00:01:14				

By default, the rows on the Events page are sorted in ascending order by the Start/Date/Time value. The columns displayed on the Events page are:

- **Type** This value indicates the type of Hold event that occurred within the recording. Valid Hold display values are: **Hold**, **Transfer**, and **Park**.
- **Duration** This value indicates the length of the Hold, rounded to the nearest second. The summary row for this column displays the total duration of the Holds (summed before any rounding) for this recording, and is rounded to the nearest second.
- **Hold Date/Time** This value displays when the Hold began in local Date/Time. The summary row for this column displays the total number of Holds that occurred for this recording.
- **Start Offset** This value displays when the Hold began as an offset from the beginning of the recording, rounded to the nearest second.
- **End Offset** This value displays when the Hold ended as an offset from the beginning of the recording, rounded to the nearest second.

Note

If the duration for a Hold event is less than .5 seconds and greater than zero (0) seconds, the Event Duration states less than 1 second.

Moving the Details pane

You can undock the Details pane from the workspace and move it to another location on your screen. To undock the Details pane, double-click the title bar. The Details pane moves from the workspace. To move the Details pane to another place on your screen, click the title bar and drag the window.

To dock the Details pane back in the workspace, double-click the title bar. The Details pane docks back in the workspace.

Hiding the Details pane

There are two ways to Hide the Details pane, Hide and Auto Hide. When you Hide the Details pane, it does not appear in the workspace. When you Auto Hide the Details pane, a tabbed page is displayed at the bottom of the workspace. Auto Hide allows you to display a pop-up pane, leaving more workspace for the Search Results View.

To Hide the Details pane, right-click on the title bar, and on the shortcut menu, click **Hide**. To display the Details pane again, right-click in the workspace and on the shortcut menu point to **Show** and click **Details**. The Details pane is displayed in the workspace.

To Auto Hide the Details pane, right-click on the title bar, and on the shortcut menu, click **Auto Hide**. A tabbed page is displayed at the bottom of the workspace. To display the Details pane again, click the tab, and the Details pane pops up in the workspace. To turn Auto Hide off, when the pane is displayed, right-click the title bar and click **Auto Hide**. The Details pane is displayed in the workspace.

Recordings

Recordings are displayed in the **Search Results** view in the workspace. Recordings that are opened from the Search Results view are listed in the **Open Recordings** folder in the **Recordings** navigation pane. From the Search results view, you can Open and Playback a recording, Score, Email, Export, Archive, Modify Retention Expiration date, and Delete recordings. You can also monitor live call recordings that are in progress.

When the Details pane is displayed with the Search Results view in the workspace, you can view Participant Data, view and modify recording Attributes, view an Audit Trail, Score a recording, and view and modify Tags.

Playback a Recording

To Playback a recorded interaction, from the Search results view in the workspace, in the list of recorded interactions, double-click on an interaction.

Search Results (14 recordings)								
Media Type	Recording Type	Recording ID	Date/Time	Expiration Date	Recording Le	Direction	Sc	
		=	A	A	=	=	A	
		4f727615-17b4-...	1/3/2019 4:00:08 PM	4/3/2019 5:00:08 PM	00:00:21	Inbound		
		30727615-b5ef-...	1/3/2019 3:57:56 PM	4/3/2019 4:57:56 PM	00:00:05	Outbound		
		30727615-8ea0-...	1/3/2019 3:57:55 PM	4/3/2019 4:57:55 PM	00:00:12	Outbound		
		23727615-f1e9-...	1/3/2019 3:57:00 PM	4/3/2019 4:57:00 PM	00:00:52	Outbound		
		11727615-1dda-...	1/3/2019 3:55:43 PM	4/3/2019 4:55:43 PM	00:00:19			
		0e727615-d3d0-...	1/3/2019 3:55:30 PM	4/3/2019 4:55:30 PM	00:00:39	Outbound		
		05727615-260c-...	1/3/2019 3:54:48 PM	4/3/2019 4:54:48 PM	00:00:11	Intercom		
		01727615-a8f7-...	1/3/2019 3:54:34 PM	4/3/2019 4:54:34 PM	00:00:24	Outbound		
		f4717615-e426-...	1/3/2019 3:53:35 PM	4/3/2019 4:53:35 PM	00:00:25	Outbound		

A Playback window, showing the interaction, is displayed.

Details

Media Details	Participant Data	Attributes	Audit Trail	Scoring	Tags	Events
	Recording Date:	1/3/2019 3:57:56 PM	Recording ID:	30727615-b5ef-d0a6-8110-		
<input checked="" type="checkbox"/>	Expiration Date:	4/3/2019 4:57:56 PM	Initiation Policy:			
<input checked="" type="checkbox"/>	Interaction ID Key:	100185172130190103	Direction:	Outbound		
	Archived:	No	Encrypted:	No		
	Recording Length:	00:00:05		Snippet Initiator:	user1 user1	
	Recording Type:	Snippet Recording	Call Type:	External		

Playback forms vary according to the Media Type.

Note: If there is an associated recording with the interaction, the Related Recording Icon  is displayed. Click this icon to display a list of related recordings.

Playback a Call

To playback a recorded Call, from the Search results view, in the list of recorded interactions, double-click on a Call. The Audio Playback window is displayed, and the recording begins to play.

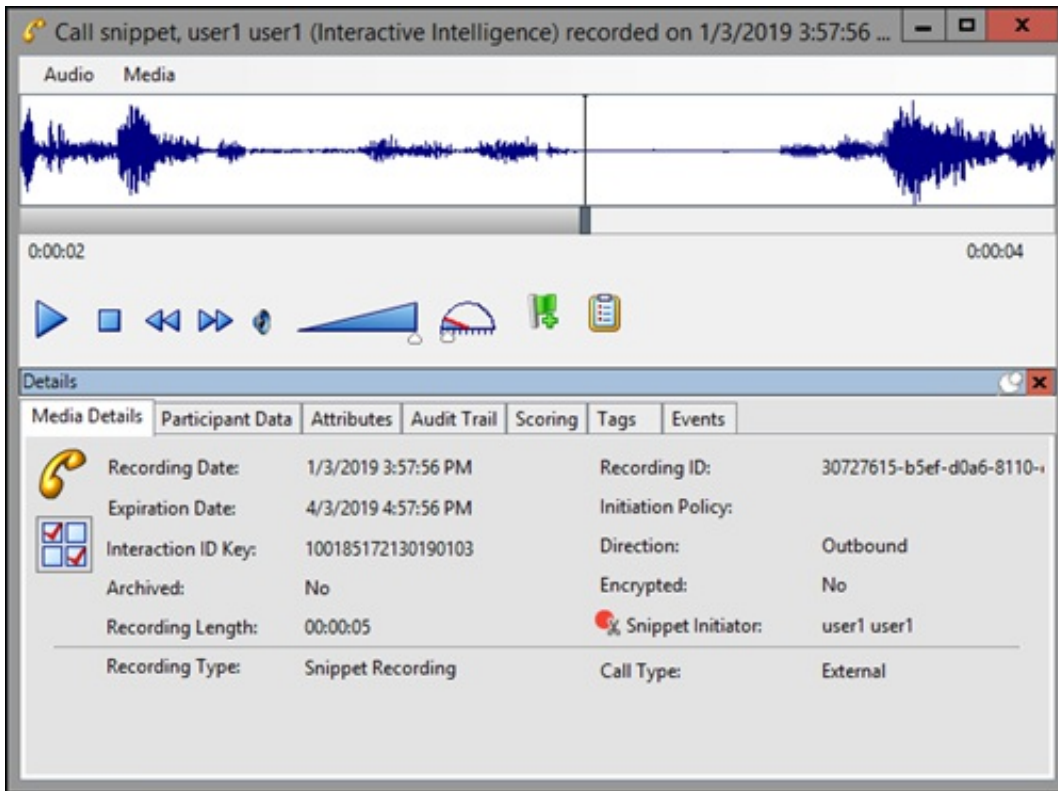

The waveform varies according to Mono or Dual-channel recordings.

Opus Dual-channel recordings

For Opus dual-channel recordings, the audio recording playback wave form displays the dual-channel audio as separate channels.

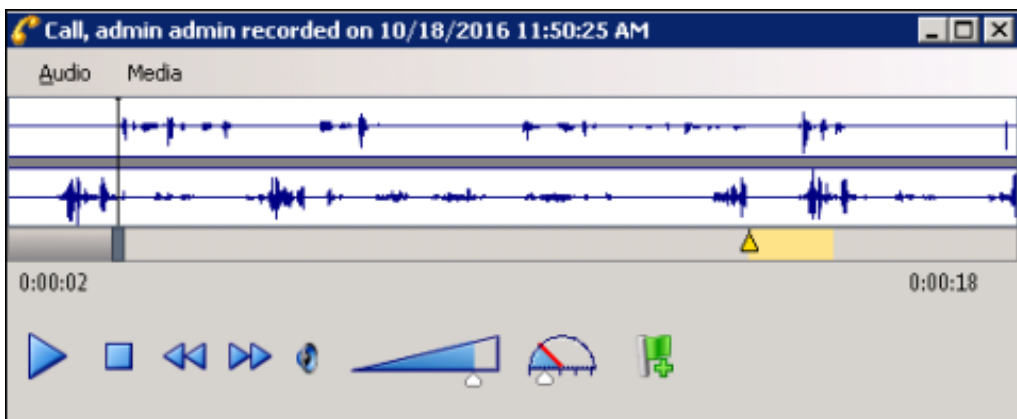

Left channel audio data is displayed in the top waveform, and Right channel audio data is displayed in the bottom waveform. The initiator of the call will always be on one of the channels, with all other participants on the audio call on the other channel. And the direction of the call will also determine which channel the participants and the initiator will be recorded on.

Important notes

- Support for the playback and management of Opus recordings within the CIC Interaction Desktop, Interaction Web Portal, and IC Business Manager applications requires CIC 2017 R2, or later. Opus recordings can be generated within CIC and Interaction Recorder starting with Media Servers at version CIC 2017 R1, or later.
- Support for Opus recordings within Interaction Recorder and CIC requires version 2017 R2 or later client and server-side components. Earlier versions of the Interaction Recorder Remote Content Servers also do not support Opus recordings and will

result in errors when archiving or exporting Opus recordings. Opus recordings can be generated within CIC and Interaction Recorder starting with 2017 R1 or later Media Servers.

For dual-channel recordings, a right-click shortcut menu allows you to switch between dual-channel and mono waveform data during playback.

Dual-channel Waveform to Mono

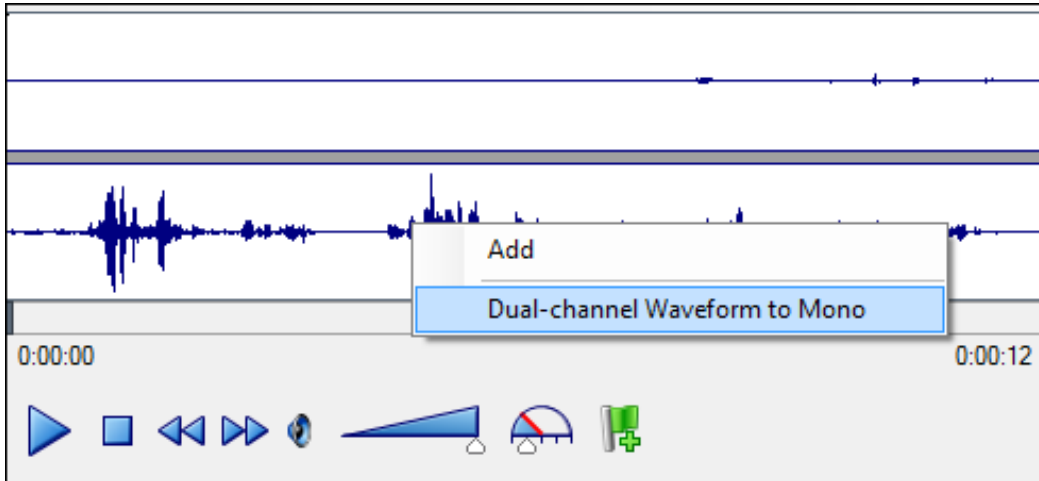

Mono waveform to Dual-channel

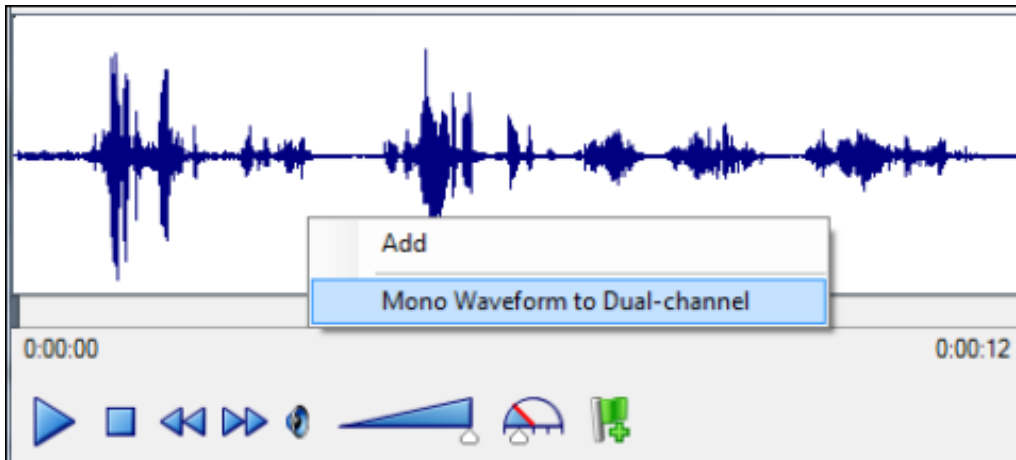

Note

Enabling the Opus (Mono) and Opus (Dual-channel) compression formats requires additional resources on the Media Servers. See the *Interaction Media Server Technical Reference* and the Interaction Media Server Sizing Calculator for details, specifically when using Dual-channel, as it requires 1 additional point on the Media Servers.

Enabling the Opus (Dual-channel) compression format requires additional disk space storage. See [Disk Space Requirements](#) for Compression Factors and Disk Space Requirements when generating Opus (Mono) and Opus (dual-channel) recordings.

Event Indicators

The playback feature automatically inserts annotations for events on the playback timeline. The timeline includes events that occurred during the call: placing the caller on Hold; transferring a call with Transfer, and transferring a call with Park.

A Hold event is indicated by a yellow triangle, a Transfer event is indicated by a purple triangle, and a Park event is indicated by a blue arrow. Text describing the event is displayed as the recording reaches the event indicator during playback.

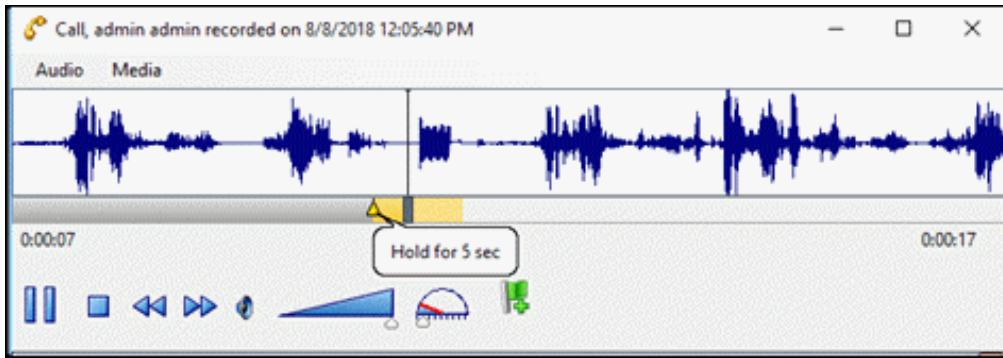

Number of holds: 2 Recording started: 7/7/2017 2:21:50 PM

Type	Duration	Hold Date/Time	Start Offset	End Offset
Hold	00:00:17	7/7/2017 2:21:58 PM	00:00:08	00:00:25
Park	00:00:11	7/7/2017 2:22:30 PM	00:00:40	00:00:51

Total Duration: 00:00:28

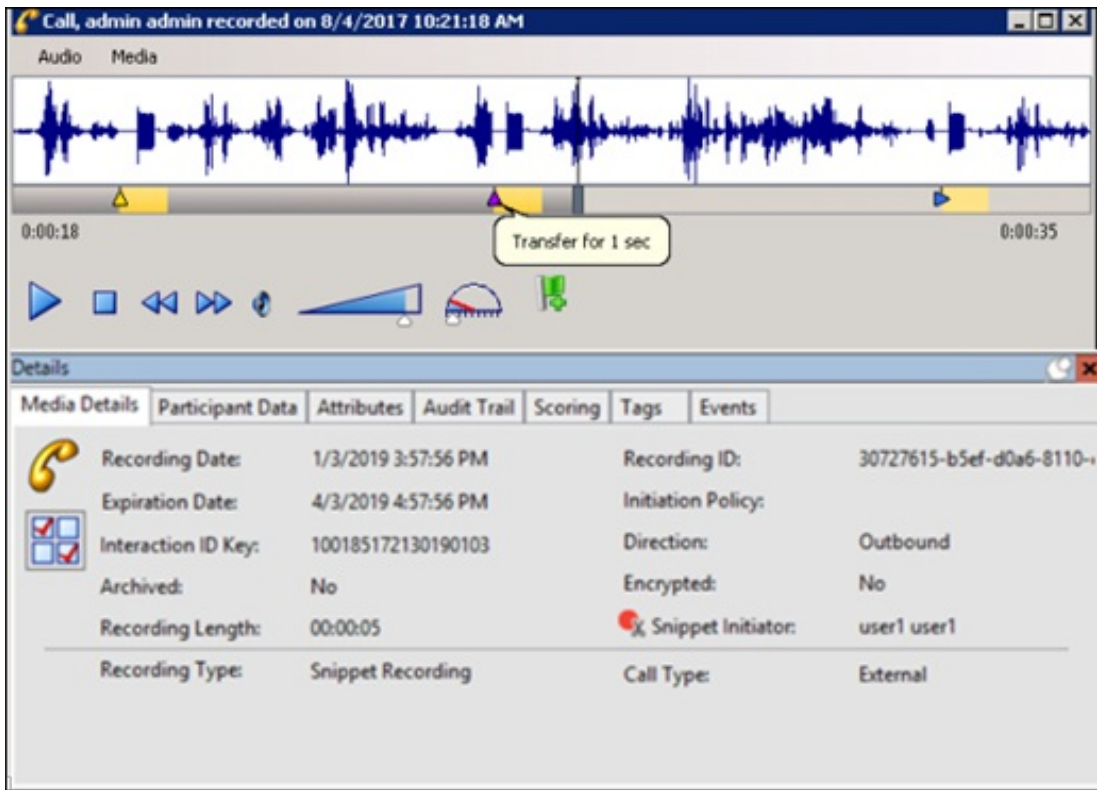

Secure Recording Pause

When an agent has initiated a Secure Recording Pause during a recorded interaction, the recording is paused for a configured period of time. As a result, the final recording contains a beep to indicate a secure segment was executed. The secure segment is omitted and compressed from the recording. During playback the listener hears the beep and the pause is indicated by a lock icon on the timeline in the playback window.



Interaction Analyzer Keywords

If a call contains Interaction Analyzer Keywords, they are listed on the Keywords page in the Details pane, and the keywords are indicated by an icon on the timeline in the playback window.

Details							
Participant Data		Attributes	Audit Trail	Scoring	Tags	Keywords	Events
Customer Score			Agent Score				
Total	Positive	Negative	Total	Positive	Negative		
4	5	-1	10	10	0		



A tooltip with the spotted keyword pops up as the recording plays.

Keyword icons that point to the right are for the agent, and the icons that point to the left are for the customer. Here is a description of the Keyword Icons.

Keyword Icon	Description
	The indicated keyword has a zero score for the agent
	The indicated keyword has a negative score for the agent
	The indicated keyword has a positive score for the agent
	The indicated keyword has a zero score for the customer
	The indicated keyword has a negative score for the customer
	The indicated keyword has a positive score for the customer

For more information on setting Interaction Analyzer Keywords scores, see the *Interaction Analyzer Technical Reference* in the PureConnect Documentation Library.

Note

If a call recording is in progress when the recording is opened, the Playback window is replaced with the message **This recording is currently in progress and cannot be retrieved at this time.** You can monitor a recording in process. For more information, see [Monitor a Live Call](#).

Menu Bar

The menu bar allows you to control settings for **Audio** and view **Media** information properties.

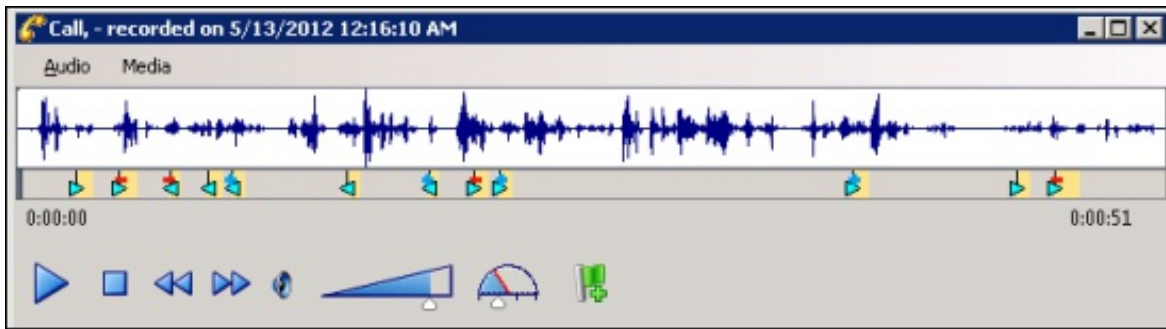

Audio



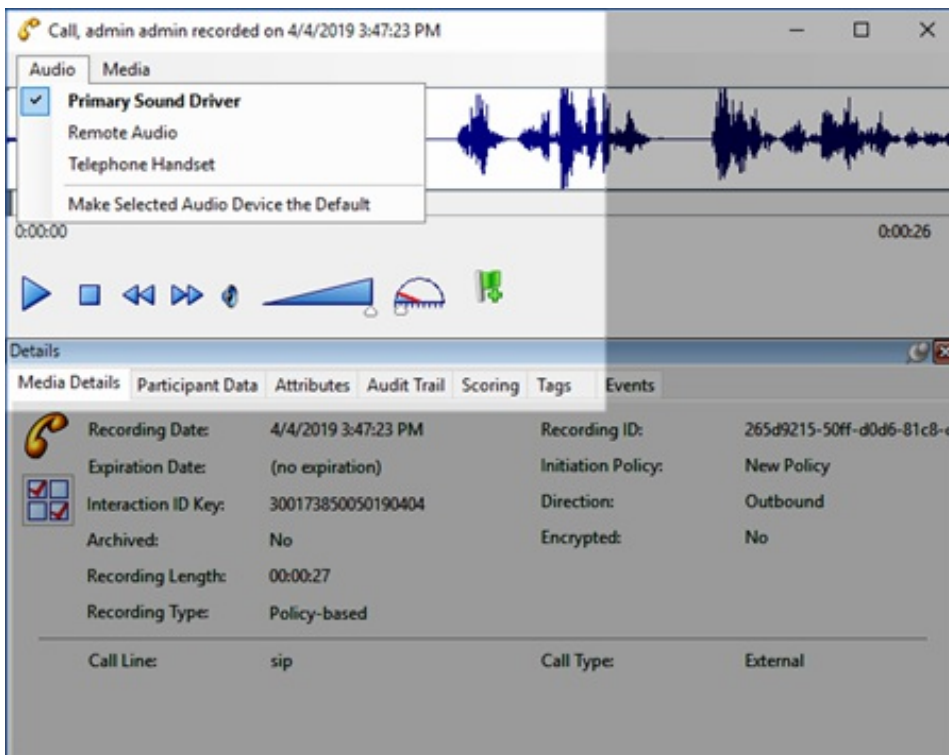

Use the **Audio** menu to select the audio device for the playback. The options are **Primary Sound Driver**, **Remote Audio**, or **Telephone Handset**. A list of available Playback Devices from Windows Sound is also displayed between the Primary Sound Drive and the Telephone Handset options.



The default audio device is displayed in the Audio menu in a bold font. The active (currently selected) Audio device menu item is selected (checked). You can also make the selected Audio device the default on this menu. Audio timing indicators display the current position in the recording and the total time of the recording. Note, when using the handset for playback, the WAV form is not displayed.

Playback through Primary Sound Driver

Here are the playback controls that allow you to adjust the audio playback using your primary sound driver.

Playback Control	Function
	Play or pause the recording
	Stop the recording
	Reverse or fast forward the recording
	Volume slider for audio playback
	Speed slider for audio playback The available speed settings are: 0.5x, 1.0x, 1.1x, 1.2x, 1.3x, 1.4x, 1.5x, 2.0x, and 4.0x.

Playback Through Telephone Handset

If you are playing back a recording through a telephone handset, use the telephone keypad to control the playback.

To control the playback:

Press	To
1	Slow down the recording
2	Speed up the recording
4	Decrease the volume
5	Increase the volume
7	Rewind ten seconds and continue playback
8	Fast forward ten seconds and continue playback

Note

When playing back a recording through the telephone handset, the audio disconnects when the recording has finished playing or when the stop button is pressed.

Also, when using the handset for playback, the WAV form is not displayed.

Media

Use the **Media** menu to view Media Information properties, including Length, Audio format, and compression type. To view this information, click **Media**, and then click **About**. For example, the Media Information for a Dual-channel Opus recording is:

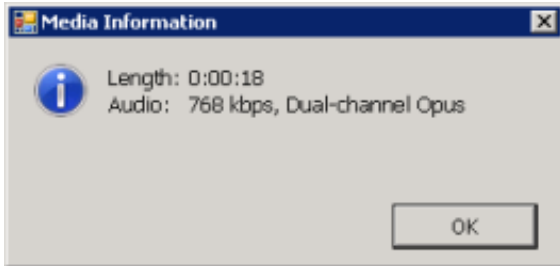

And the Media Information for a Mono Opus recording is:

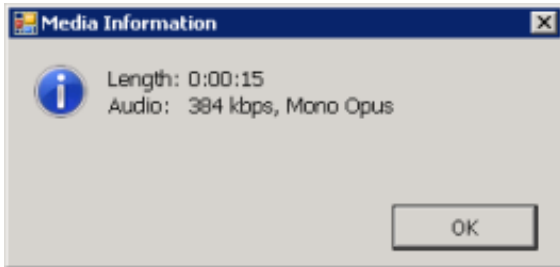

Waveform

The Waveform displays a graphic representation of the sound in the recording. The Waveform area includes a recording timeline that includes a position indicator and time, and the length of the recording. Bookmarks are displayed on the playback timeline.

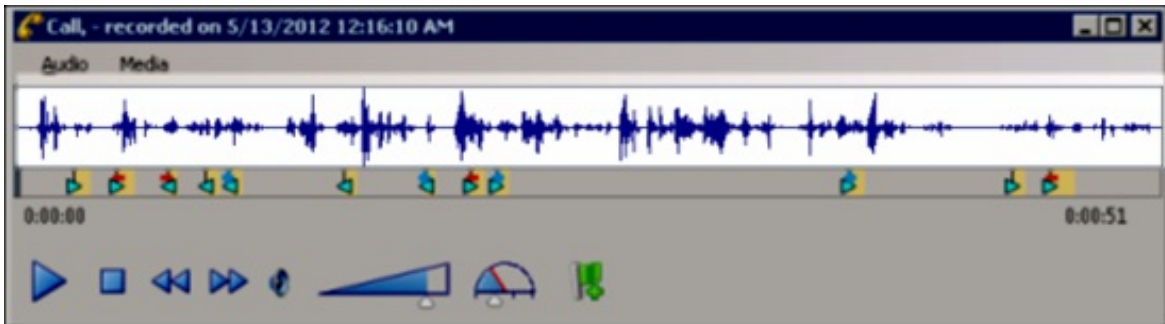



Note

When using the handset for playback, the WAV form is not displayed.

Bookmarks

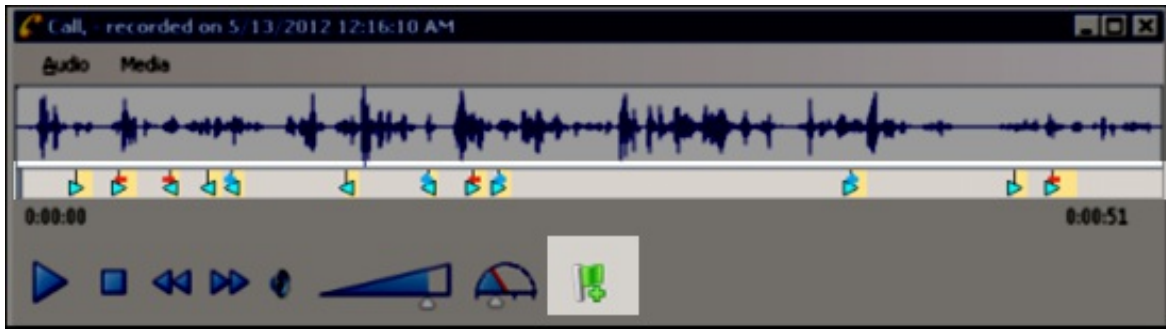
Bookmarks can be added to Audio recordings, in the Audio Playback window, to identify places in the recording that you can easily return to. You can add a Bookmark while the audio is playing, or you can pause the audio to add a Bookmark. Bookmarks are identified by a custom label you create. You can also indicate a Start and End time for your Bookmark.



To add a Bookmark, while the audio recording is playing, click the Bookmark control . You can also pause the recording while adding a Bookmark. In the Add Bookmark dialog, type the label information, and click OK. The Bookmark is inserted at the point where you clicked the Bookmark control. To Bookmark a span of Time in a recording, use the Start Time and End Time fields.

To Edit or Delete a Bookmark, right-click a Bookmark and on the shortcut menu select Edit or Delete.

Note

When using the handset for playback, the WAV form is not displayed. Entering and viewing bookmarks requires the use of computer speakers, rather than a handset.

Bookmark Audit Trail entries

When Bookmarks are added, edited, and deleted, the related modified recording audit trail entry contains formatted comments. The comments include Bookmark text and Start and End times. Bookmarks can be up to 1024 characters, but the Bookmark comment text displays the first 512 characters, followed by an ellipsis.

Audio Playback Details pane

The Details pane is included in the Audio Playback window for your reference. You can use the Scoring page to add a Questionnaire or to Score this recording. You can use the Tags page to Add or Edit tags for a recording.

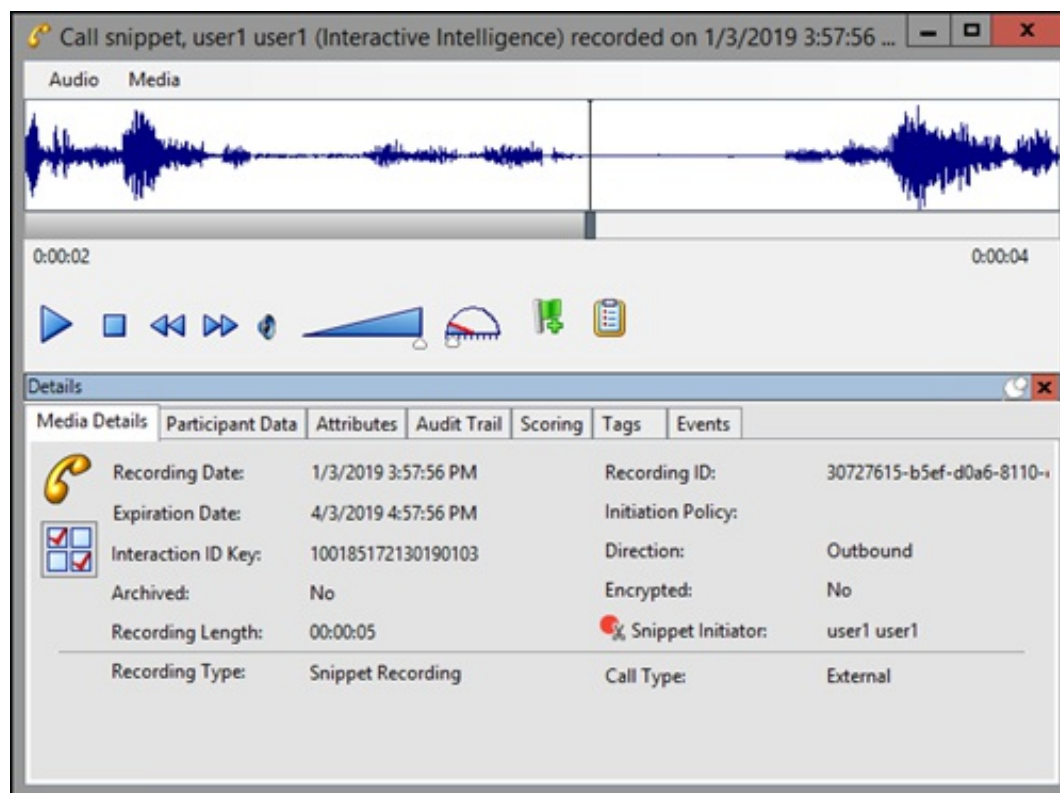

Monitor a Live Call

A live call that is in the process of being recorded can be monitored. As the call is being recorded, you can **Join** the call, **Listen** to the call, or **Coach** the agent during the call.

Assigning Security Rights

To monitor a live call, the monitoring user must have the Security Rights to **Coach**, **Join**, or **Listen** to a call. In the Security Rights **Category: User** under **Interaction Command Rights**, select **Coach**, **Join**, or **Listen**.

The monitoring user also needs Access Rights to **View**, **Modify**, and **Monitor** the call initiator's queues, such as Station Queues, User Queues, or Workgroup Queues, assigned under Access Control **Category: Queues**.

Note For Intercom calls, the monitoring user needs Access Rights for the initiator's queue *and* the respondent's queue to monitor a live intercom call.

Monitoring a Live Call

To monitor a live call recording in progress, follow these steps.

1. Run a recording search with search attributes that match the on-going call.
2. In the search results view double-click the call recording in progress. The recording playback window opens.

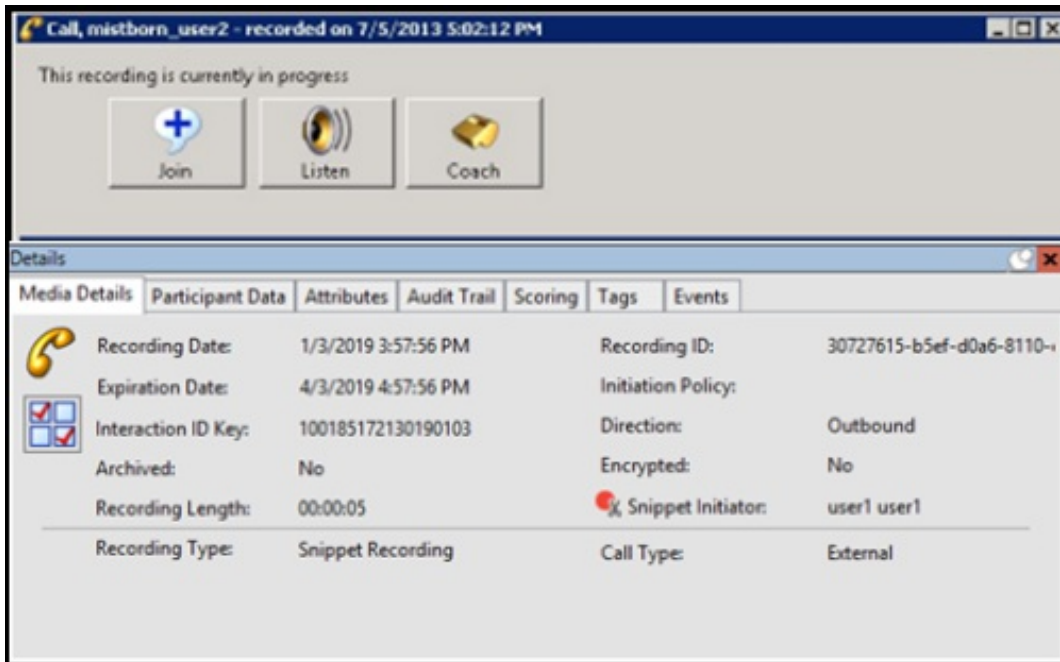

3. The dialog displays a live monitoring button bar that includes **Join**, **Listen**, and **Coach** options. To monitor the live call, click a button.

Live Monitoring Options

The following is a description of the live monitoring button bar options. The buttons are not available if the monitoring user does not have Security Rights to join, listen, or coach an interaction, or does not have Access Rights for any of the call initiator's queues.

Live Monitoring Options	
Option	Description
Join	Click this button to join the call in progress.
Listen	Click this button to listen to the call in progress.
Coach	Click this button to listen to the call and speak only to the agent on the call.

The live monitoring buttons are not available while processing a click for any of the buttons on the bar and also not available if the monitoring user does not have a station or is already a participant on the call.

Note

Live Monitoring is not available for conference calls. When a conference call is in progress, the Join, Listen, and Coach options are not available. A message is displayed indicating the call is part of a conference and still in progress, and the recording is not available.

Playback a Chat

To display a recorded Chat, from the Search results view, in the list of recorded interactions, double-click on a Chat .

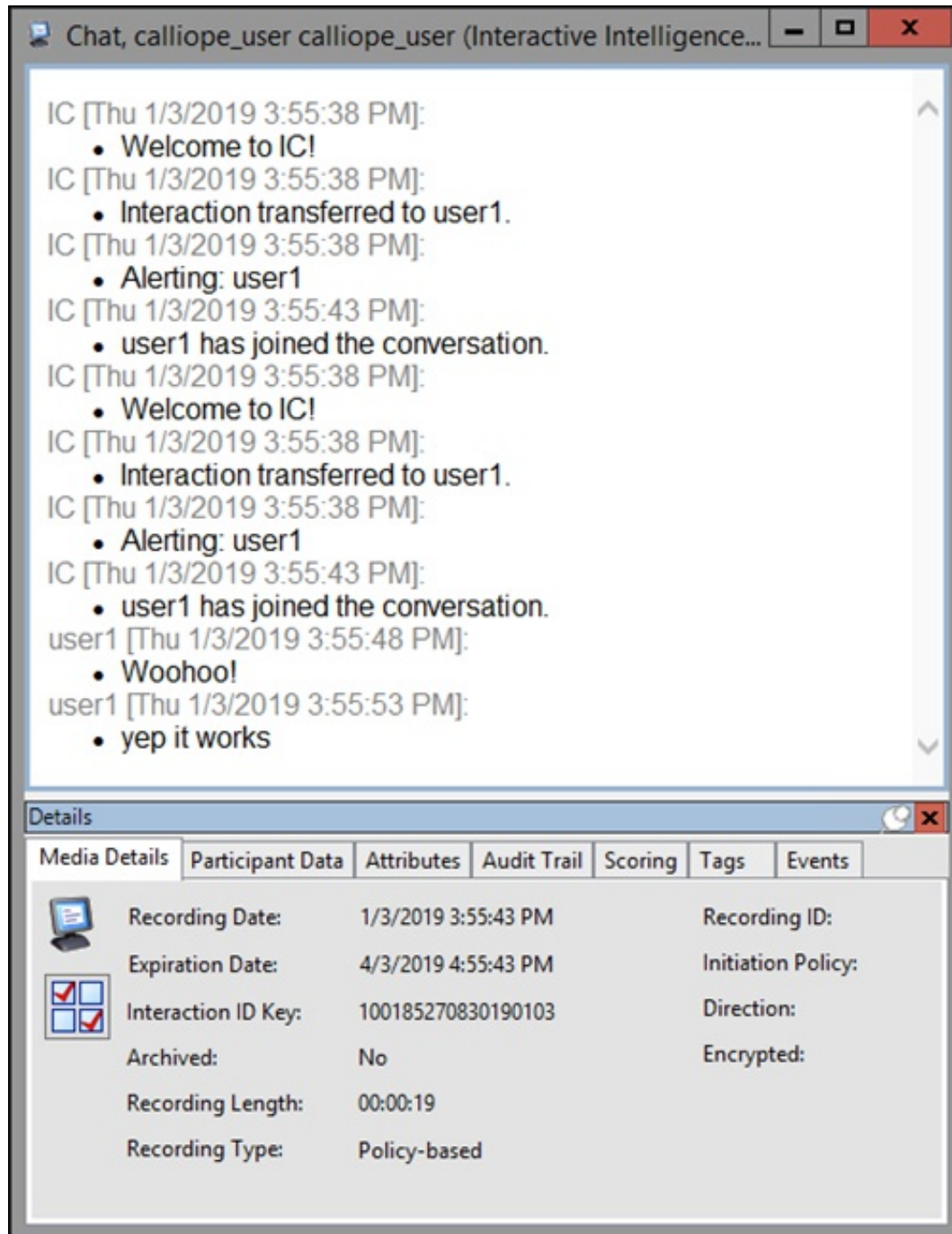

The Chat Playback window is displayed. The interaction Details pages are displayed at the bottom of this window for your reference. You can use the Scoring page to add a Questionnaire or to Score this recording.



The screenshot shows a window titled "Chat, calliope_user calliope_user (Interactive Intelligence...". The main area displays a chat transcript with the following messages:

- IC [Thu 1/3/2019 3:55:38 PM]:
 - Welcome to IC!
- IC [Thu 1/3/2019 3:55:38 PM]:
 - Interaction transferred to user1.
- IC [Thu 1/3/2019 3:55:38 PM]:
 - Alerting: user1
- IC [Thu 1/3/2019 3:55:43 PM]:
 - user1 has joined the conversation.
- IC [Thu 1/3/2019 3:55:38 PM]:
 - Welcome to IC!
- IC [Thu 1/3/2019 3:55:38 PM]:
 - Interaction transferred to user1.
- IC [Thu 1/3/2019 3:55:38 PM]:
 - Alerting: user1
- IC [Thu 1/3/2019 3:55:43 PM]:
 - user1 has joined the conversation.
- user1 [Thu 1/3/2019 3:55:48 PM]:
 - Woohoo!
- user1 [Thu 1/3/2019 3:55:53 PM]:
 - yep it works

Below the transcript is a "Details" panel with the following tabs: Media Details, Participant Data, Attributes, Audit Trail, Scoring, Tags, and Events. The "Media Details" tab is active, showing the following information:

	Recording Date:	1/3/2019 3:55:43 PM	Recording ID:
	Expiration Date:	4/3/2019 4:55:43 PM	Initiation Policy:
	Interaction ID Key:	100185270830190103	Direction:
	Archived:	No	Encrypted:
	Recording Length:	00:00:19	
	Recording Type:	Policy-based	

Playback an Email

To display a recorded Email, from the Search results view, in the list of recorded interactions, double-click on an Email .

The Email Playback window is displayed. The interaction Details pages are displayed at the bottom of this window for your reference. You can use the Scoring page to add a Questionnaire or to Score this recording.

The screenshot shows a window titled "Email, calliope_user calliope_user (Interactive Intelligen...". The email content is as follows:

From: Customer1 Sent: Thursday, January 3, 2019 3:53:59 PM
To: user1
Cc:
Bcc:
Subject: RE: Some Sort of Business Thing

Sounds perfect.

-----Original Message-----
From: user1 [mailto:user1@lab.com]
Sent: Thursday, January 3, 2019 3:50:40 PM
To: calliope_user
Subject: Some Sort of Business Thing

Hello,

I'm sending a business email to setup some sort of business meeting.

Nice business,
- user1

Below the email content is a "Details" section with the following tabs: Media Details, Participant Data, Attributes, Audit Trail, Scoring, Tags, Events. The "Media Details" tab is active, showing the following information:

Recording Date:	1/3/2019 3:53:35 PM	Recording ID:	
Expiration Date:	4/3/2019 4:53:35 PM	Initiation Policy:	
Interaction ID Key:	100185270530190103	Direction:	
Archived:	No	Encrypted:	
Recording Length:	00:00:25		
Recording Type:	Policy-based		

If an email has attachments that you want to save, right-click and select **Save As** or **Save All**. To do this, the user must have the **export/archive the recording** security right assigned in interaction Recorder Policy Editor, in Interaction Administrator.

Note



The Related Recordings list for an email displays all related recordings including screen recordings associated with the interaction. The list also displays the original email and all replies and forwards. The email you are viewing is grayed in the list, so you can tell where you are in the email thread.

Playback a Social Media Conversation

To display a recorded social media conversation, in the list of recorded interactions, double-click on a Social Conversation .

The Social Conversation playback window is displayed. The interaction Details pages are displayed at the bottom of the window for your reference. You can use the Scoring page to add a Questionnaire or to Score the recording.

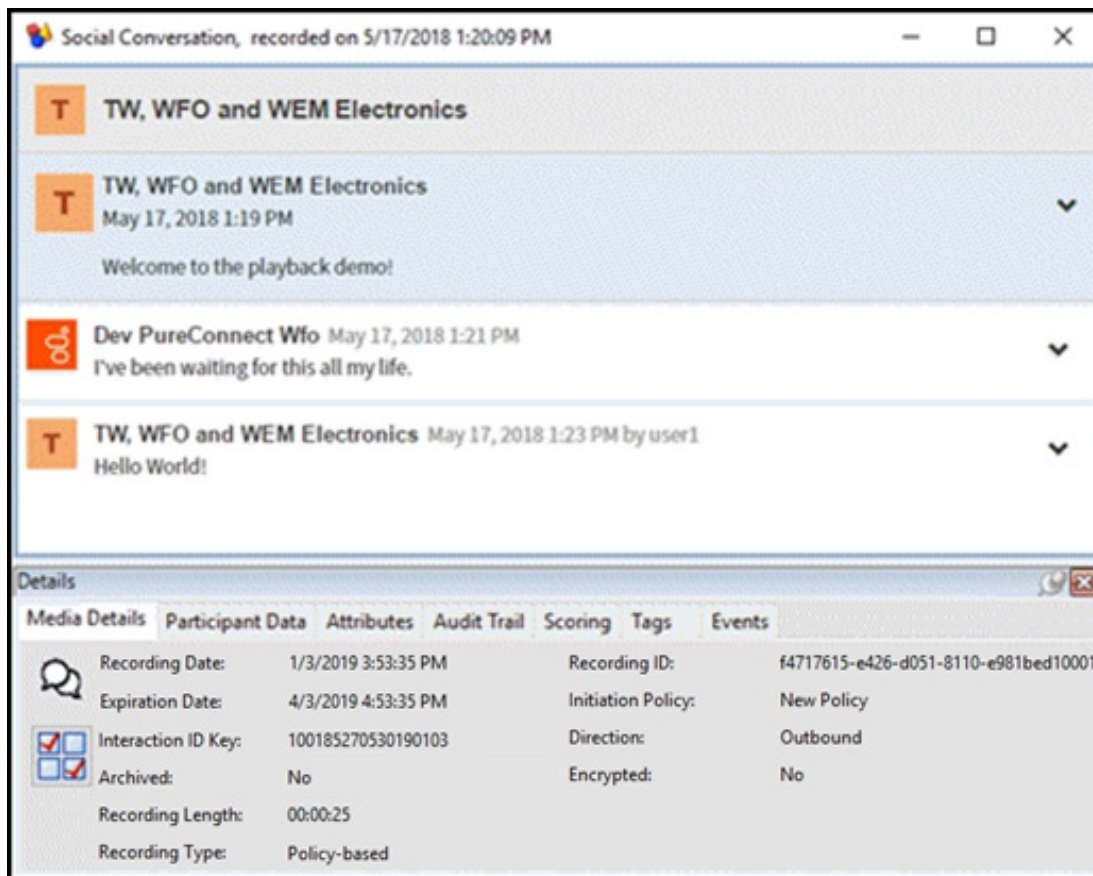

The screenshot shows a window titled "Social Conversation, recorded on 5/17/2018 1:20:09 PM". The main content area displays a list of messages:

- TW, WFO and WEM Electronics** (grayed out)
- TW, WFO and WEM Electronics** (May 17, 2018 1:19 PM): Welcome to the playback demo!
- Dev PureConnect Wfo** (May 17, 2018 1:21 PM): I've been waiting for this all my life.
- TW, WFO and WEM Electronics** (May 17, 2018 1:23 PM by user1): Hello World!

Below the messages is a "Details" section with the following data:

Media Details	Participant Data	Attributes	Audit Trail	Scoring	Tags	Events
	Recording Date:	1/3/2019 3:53:35 PM	Recording ID:	f4717615-e426-d051-8110-e981bed10001		
	Expiration Date:	4/3/2019 4:53:35 PM	Initiation Policy:	New Policy		
<input checked="" type="checkbox"/>	Interaction ID Key:	100185270530190103	Direction:	Outbound		
<input checked="" type="checkbox"/>	Archived:	No	Encrypted:	No		
	Recording Length:	00:00:25				
	Recording Type:	Policy-based				

Playback a Social Direct Message

To display a recorded social direct message, in the list of recorded interactions, double-click on a Social Direct Message .

The Social Direct Message playback window is displayed. The interaction Details pages are displayed at the bottom of the window for your reference. You can use the Scoring page to add a Questionnaire or to Score the recording.

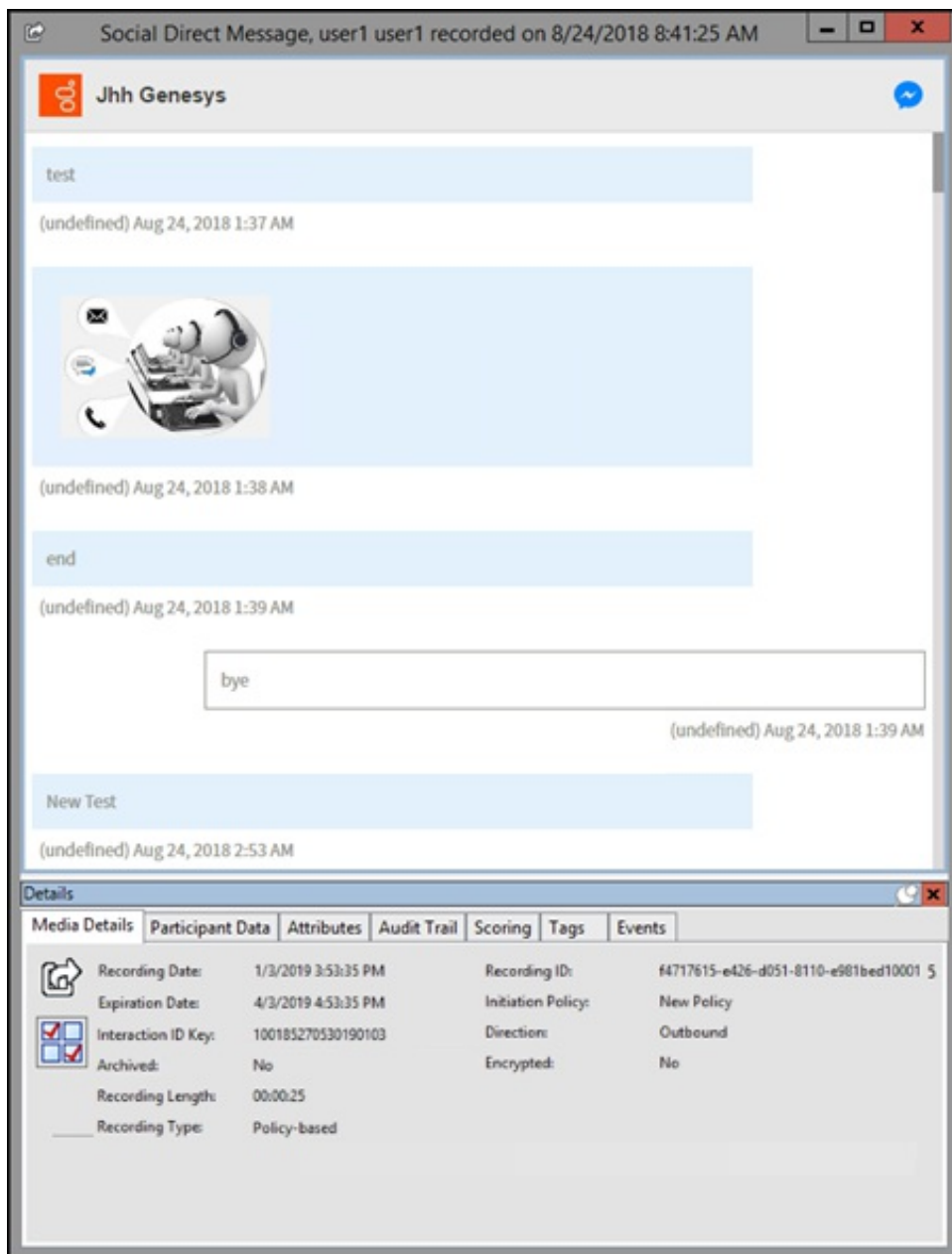

Social Direct Message, user1 user1 recorded on 8/24/2018 8:41:25 AM

Jhh Genesys

test
(undefined) Aug 24, 2018 1:37 AM





(undefined) Aug 24, 2018 1:38 AM

end
(undefined) Aug 24, 2018 1:39 AM

bye
(undefined) Aug 24, 2018 1:39 AM

New Test
(undefined) Aug 24, 2018 2:53 AM

Details

Media Details	Participant Data	Attributes	Audit Trail	Scoring	Tags	Events
	Recording Date:	1/3/2019 3:53:35 PM	Recording ID:	f4717615-e426-d051-8110-e901bed10001 5		
	Expiration Date:	4/3/2019 4:53:35 PM	Initiation Policy:	New Policy		
	Interaction ID Key:	100185270530190103	Direction:	Outbound		
	Archived:	No	Encrypted:	No		
	Recording Length:	00:00:25				
	Recording Type:	Policy-based				

Playback a Screen Recording

To only display a Screen Recording, from the Search results view, double-click a Screen Recording . The Screen Recording Playback window is displayed.

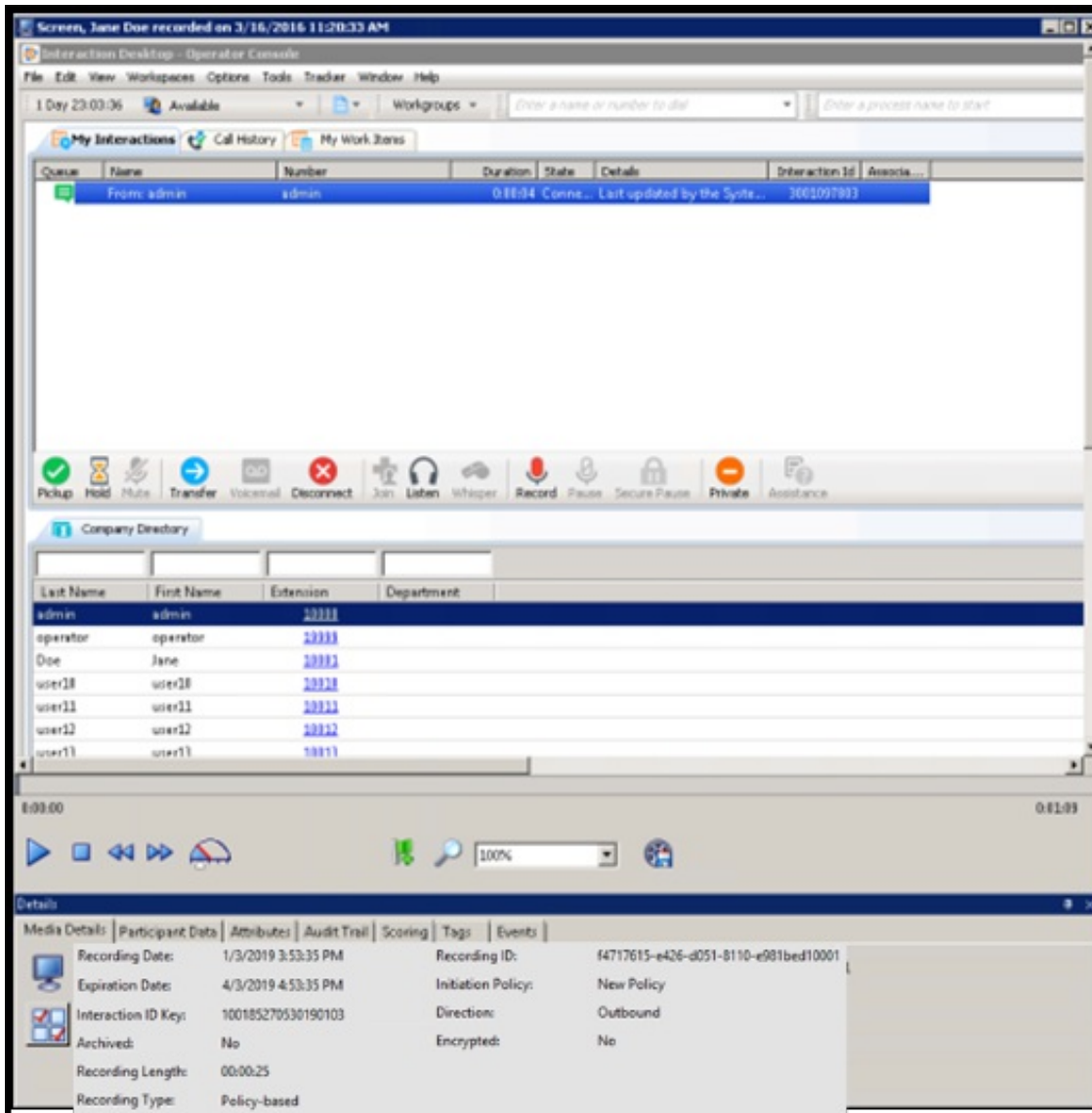

The screenshot displays the Interaction Desktop Operator Console interface. At the top, a window titled "Screens, Jane Doe recorded on 3/16/2016 11:20:33 AM" is open. The main area shows a table of interactions with the following data:

Queue	Name	Number	Duration	State	Details	Interaction ID	Assoc...
	From: admin	admin	0:00:04	Conn...	Last updated by the Synte...	3001097833	

Below the table is a toolbar with various call control icons: Pickup, Hold, Mute, Transfer, Voicemail, Disconnect, Join, Listen, Whisper, Record, Pause, Secure Pause, Private, and Assistance. A "Company Directory" section is visible, containing a table of user information:

Last Name	First Name	Extension	Department
admin	admin	20311	
operator	operator	20311	
Doe	Jane	20311	
user28	user28	20311	
user21	user21	20311	
user22	user22	20311	
user11	user11	10011	

At the bottom, a "Details" window is open, showing the following information:

Media Details	Participant Data	Attributes	Audit Trail	Scoring	Tags	Events
Recording Date:	1/3/2019 3:53:35 PM	Recording ID:	f4717615-e426-d051-8110-e981bed10001			
Expiration Date:	4/3/2019 4:53:35 PM	Initiation Policy:	New Policy			
Interaction ID Key:	100185270530190103	Direction:	Outbound			
Archived:	No	Encrypted:	No			
Recording Length:	00:00:25					
Recording Type:	Policy-based					

Playback a screen recording associated with a call

To playback a screen recording associated with a call, from the call playback window, click the Related Recording Icon  to display the related recordings. Select a related screen recording to begin playback. The screen recording playback window with audio is displayed.

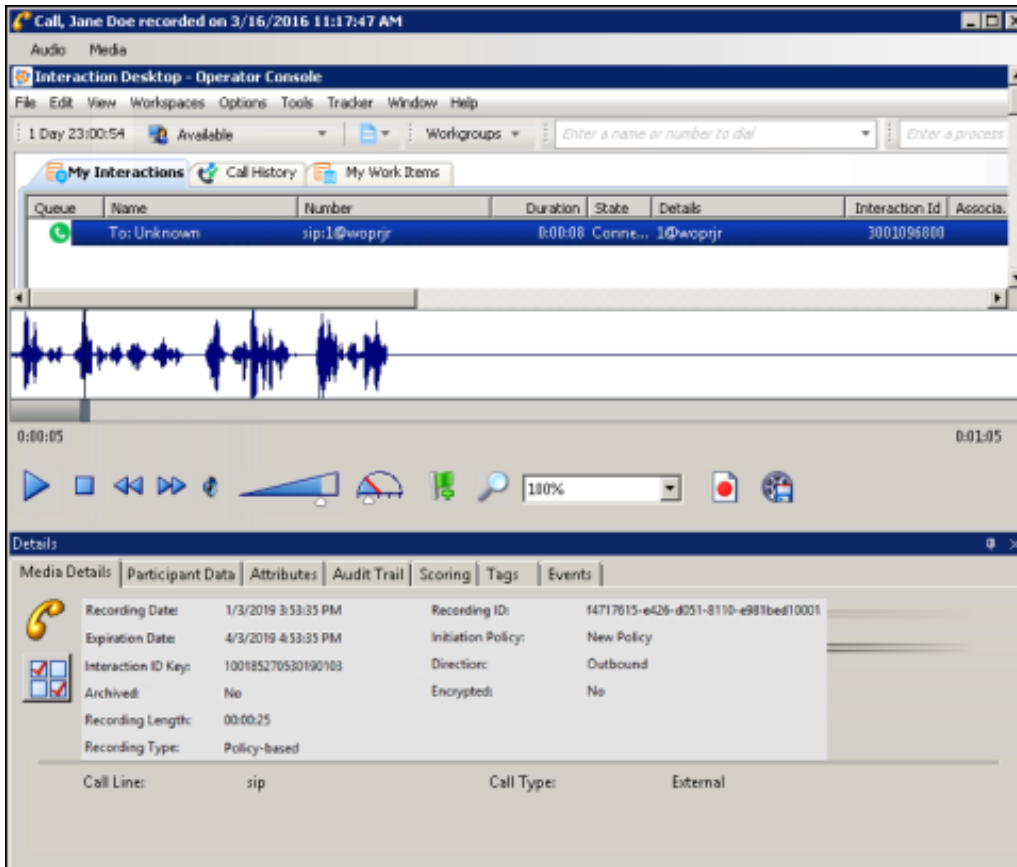

The audio controls for the recording are available. The Audio and Screen Recording stay in sync when played. If you are playing the audio through a station handset or headset and use the screen playback controls, such as forward or back, audio and video will go out of sync. To avoid audio and video going out of sync, use your computer speakers for audio playback.

The interaction Details pages are displayed at the bottom of this window for your reference. You can use the Scoring page to add a Questionnaire or to Score this recording.

Note

If a Screen Recording is selected for playback before the Store at Location has been completed, a message is displayed that the recording media is unavailable and to retry opening the recording again.

Secure Screen Recording Pause

When an agent has initiated a Secure Recording Pause during a recorded interaction, the screen recording is paused for a configured period of time. As a result, the final recording contains a beep to indicate a secure segment was executed. The secure segment is omitted and compressed from the recording. During playback the listener hears the beep and the pause is indicated by a lock icon on the timeline in the playback window.

Note

In addition there is a public API to pause and resume screen recording, providing the ability to control the screen recording with a 3rd party desktop application when entering credit card data. Refer to the Introduction to *IceLib Technical Reference* for more information.

Export a Screen Recording

Screen recordings can be exported from the screen recording playback window. The recording is exported to a Windows Media Video (WMV) format file for playback.

You *must* choose **Windows Server (Server with Desktop Experience)** when you install Windows Server 2016 or Windows server 2019. You *cannot* install Server with Desktop Experience after installation.

Windows Server 2016 and 2019 requirements for The Desktop Experience feature

For IC Business Manager, there are specific requirements for **The Desktop Experience** feature on Windows Server 2016 and Windows Server 2019. The Desktop Experience feature on Windows Server 2016 and Windows Server 2019 is optionally installed during Windows Installation using the Setup wizard. You *must* choose **Windows Server (Server with Desktop Experience)** when you install Windows Server 2016 and Windows Server 2019.

If the Desktop Experience Feature is not enabled, screen recordings are not available for export, and the Export screen recording

icon is unavailable .

Exporting a screen recording

Follow these steps to export a screen recording.

1. From the screen recording playback window, click the **Export** screen recording icon . The **Select a folder for exported recordings** dialog is displayed.
2. Select a folder for the exported screen recording, and click **OK**.
3. The **Exporting the Screen capture** progress indicator is displayed.

Open Recordings

When you Playback a recorded interaction, and the recording is open in the workspace, it is listed in the **Open Recordings** folder in the Recordings navigation pane. Use the Open Recordings list to navigate to a recording.

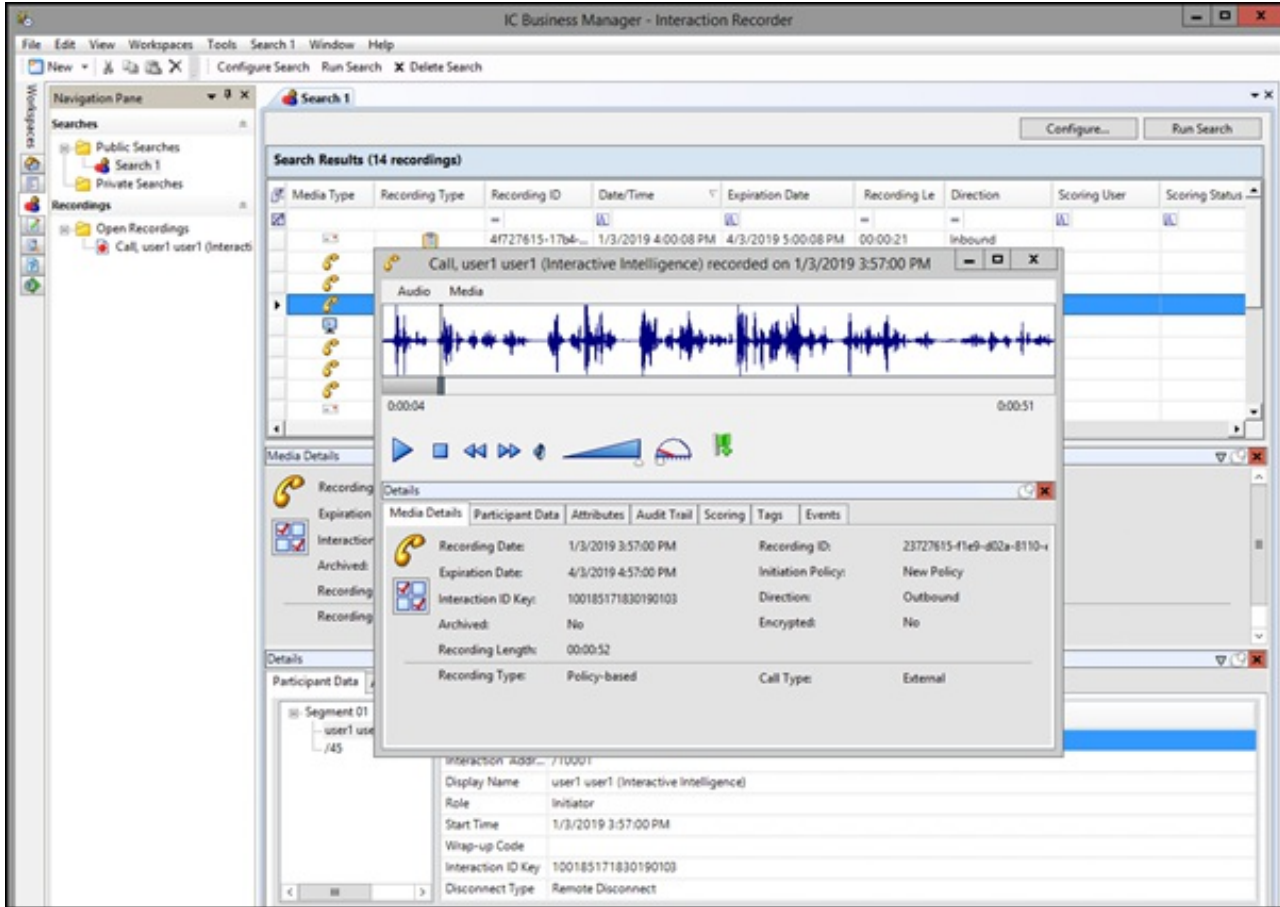

You can playback and review multiple recording Media Types at the same time. For example, you can listen to an audio recording while viewing a screen recording of the interaction.

Score a Recording

Accessing the Scoring page

Access the Scoring page from the Search Results view in the workspace.

Media Type	Recording Type	Recording ID	Date/Time	Expiration Date	Recording Length	Direction	Scoring User	Scoring Status
		4f727615-17b4...	1/3/2019 4:00:08 PM	4/3/2019 5:00:08 PM	00:00:21	Inbound		
		30727615-b5ef...	1/3/2019 3:57:56 PM	4/3/2019 4:57:56 PM	00:00:05	Outbound		
		30727615-8e00...	1/3/2019 3:57:55 PM	4/3/2019 4:57:55 PM	00:00:12	Outbound		
		23727615-f1e9...	1/3/2019 3:57:00 PM	4/3/2019 4:57:00 PM	00:00:52	Outbound		
		11727615-1dda...	1/3/2019 3:55:43 PM	4/3/2019 4:55:43 PM	00:00:19			
		0e727615-d3d0...	1/3/2019 3:55:30 PM	4/3/2019 4:55:30 PM	00:00:39	Outbound		
		05727615-260c...	1/3/2019 3:54:48 PM	4/3/2019 4:54:48 PM	00:00:11	Intercom		

Media Details

Recording Date: 1/3/2019 3:55:30 PM Recording ID: 0e727615-d3d0-d000-8110-e981bed10001
Expiration Date: 4/3/2019 4:55:30 PM Initiation Policy: New Policy
Interaction ID Key: 100185171530190103 Direction: Outbound
Archived: No Encrypted: No
Recording Length: 00:00:39
Recording Type: Policy-based Call Type: External

Details

Participant Data Attributes Audit Trail **Scoring** Tags Events

Assign Questionnaire... Score

Questionnaire	Scoring Date/Time	Status	Scoring User	Scored User	Marked for Calibration
---------------	-------------------	--------	--------------	-------------	------------------------

Use the Scoring page in the Details pane to access a Questionnaire and Score a recording.

Questionnaires that have previously been assigned to a recording are displayed on the Scoring page. Additional Questionnaires can be assigned to the recording on the Scoring page. Only Questionnaires that have been published are available for scoring.

Notes

- Non-admin users only see Questionnaire scorecards that they have scored. To allow users to see all scorecards for a recording, the CIC Administrator can create a Security Policy so a user can **view scorecards**. This Security Policy can be applied to Agents or Roles. Questionnaire Directory Admin Access and other security rights will still apply. For non-admin users, in order to finish a scorecard that has already been scored by another user, the user must first save the scorecard to take ownership and then the user can finish the scorecard.

- When a scoring user does not have the **can view participant contact information** security right for a recording, for security purposes the scored agent's name is not displayed, and the name is replaced with asterisks. Also, in a recording that has multiple participants, the Select Participant dialog displays participants by number when the scoring user does not have the **can view participant contact information** security right.

Assigning a Questionnaire

To assign a Questionnaire to an interaction, click **Assign Questionnaire**, and select a Questionnaire from the **Select Questionnaire** dialog.

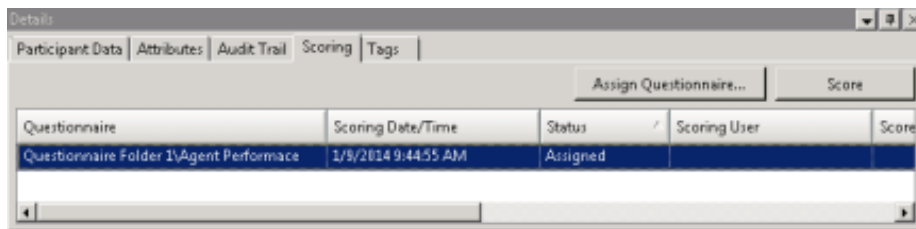

Note To assign a questionnaire to a recording you must have the **Can Assign Questionnaires** security right, assigned in Policy Editor.

When you click **Assign Questionnaire** the **Select Questionnaire** dialog is displayed.

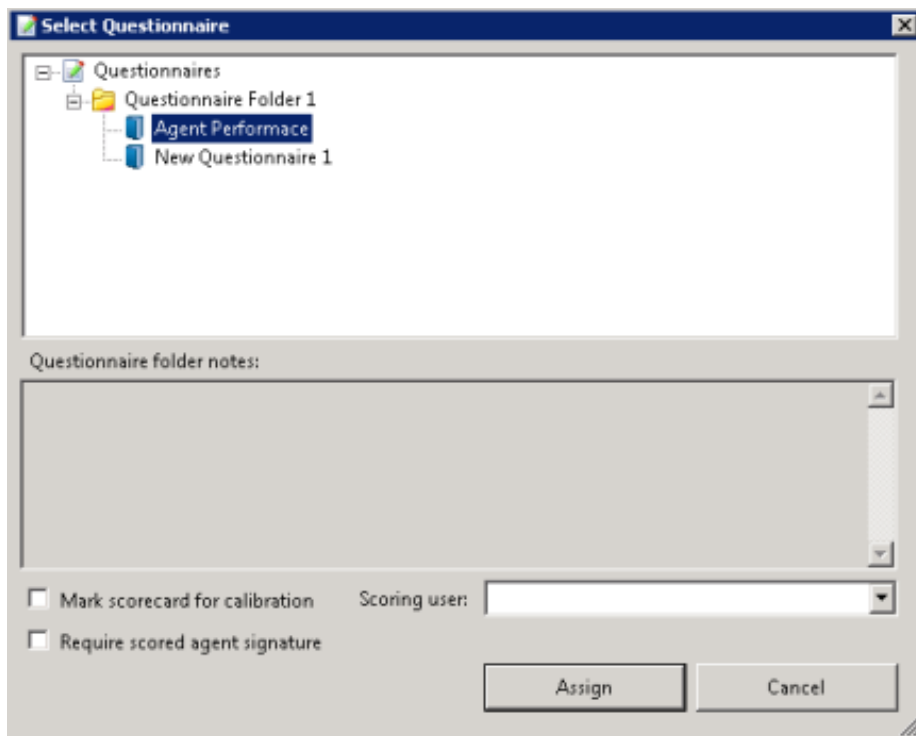

To assign a user to score the recording, select the **Scoring user** from the drop-down list. To select the completed scorecard for calibration purposes, select the **Mark scorecard for calibration** check box. To require an agent signature on the completed scorecard, select the **Require scored agent signature** check box.

Scoring a recording

To score a recording, on the Scoring page, click **Score**. The Scorecard is displayed.

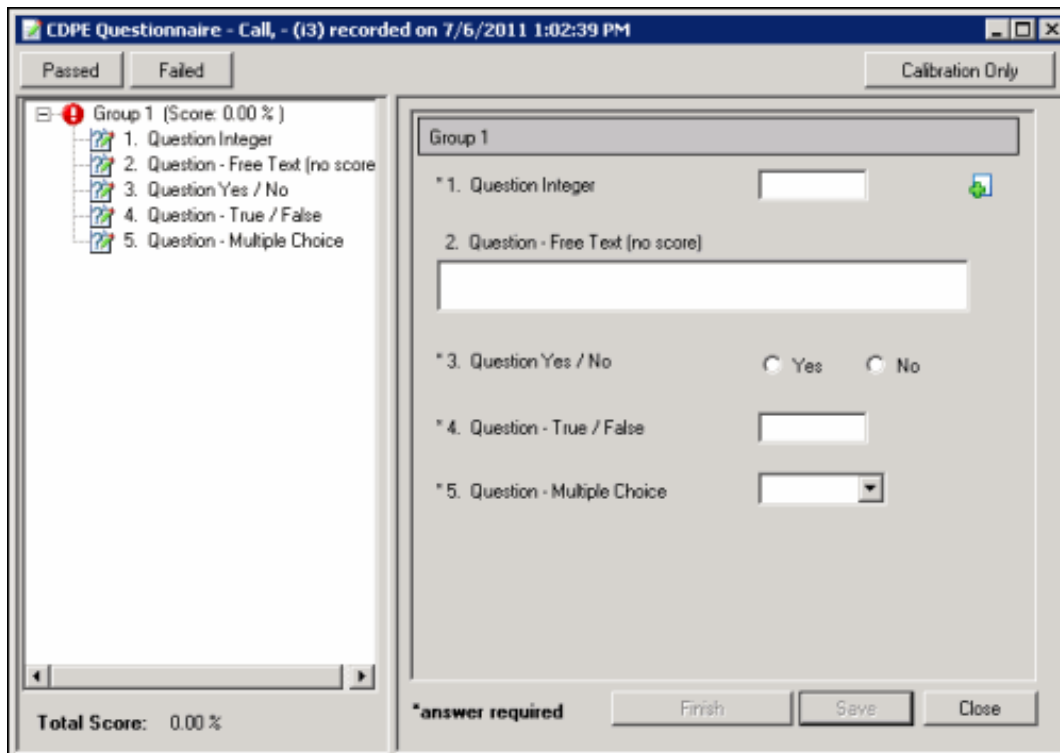

For detailed Scorecard information, from the Scorecard press F1 and the Scoring Dialog Help topic is displayed.

The media player, depending on the type of interaction, is launched displaying details of the recording. Here is an example of an Audio Playback. Details of the interaction are displayed in the Playback window.

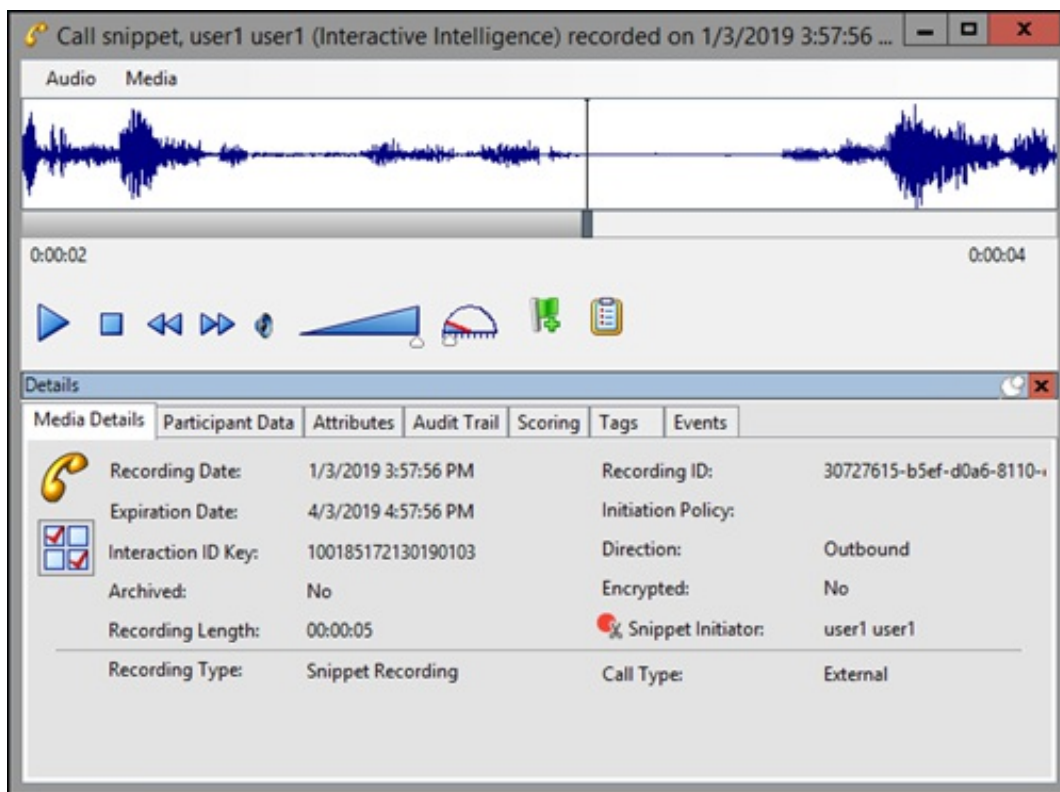

To save a scored interaction to be emailed or to finish scoring later, click **Save**.

When you have completed scoring the interaction, click **Finish**. If the Scorecard has been failed, the Finish button is labeled **Finish (Failed)**.

Finish a Scorecard

Finishing a scorecard makes it available for reporting. When the **Finish Scorecard** message is displayed, you can require the scored agent to sign the scorecard.

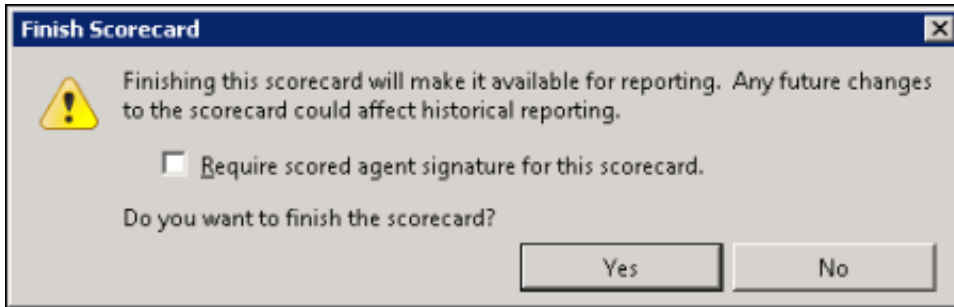

Note

Scored agents must have the **Can View Scorecards** security right, assigned in Policy Editor for the scored recording, in order to sign the scorecard and enter comments.

Scorecard Signature

Selecting the **Require scored agent signature for this scorecard** check box allows an agent to sign-off on a scorecard and enter comments. When a Finished Scorecard has been selected for sign-off, only the Scored User (agent) and the Current User with the **Override Finished Scorecards** Security Right are allowed to modify the sign-off state and specify sign-off comments.

Notes

-Scored agents are always allowed to view signature comments.

- Non-scored users must have the **can view scorecard signature comments** security right, assigned in Policy Editor for the scored recording, in order to see the signature comments after the scorecard has been signed.

When an agent is viewing a scorecard that requires a signature, the **Sign Scorecard** button is available at the bottom of the scorecard.

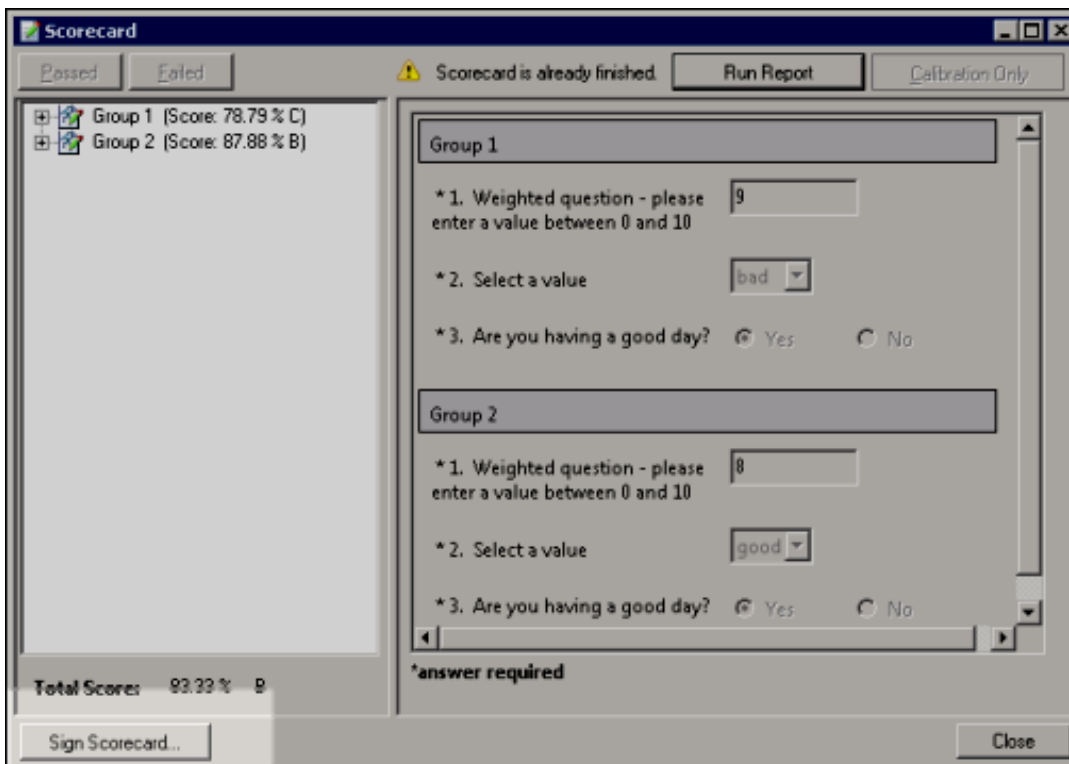

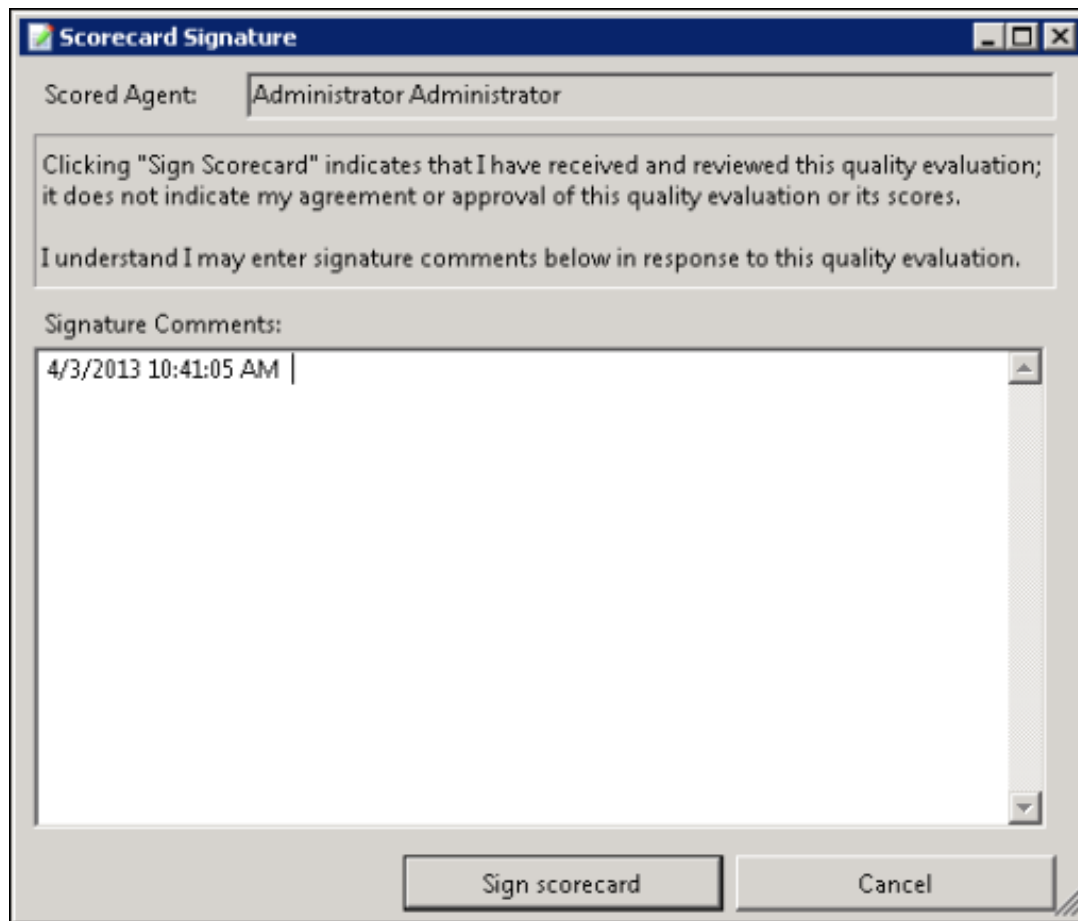

Clicking **Sign Scorecard** displays the **Scorecard Signature** dialog where comments can be made and the scorecard signed.



Finished Scorecard Group Icons

When you have finished the scorecard, different icons will be displayed for the group node in the scorecard navigation tree based on whether the group is complete or not.

-  Group is complete, that is, all required questions have been answered or marked as Not Applicable (N/A).
-  Group is not complete.

Signed Scorecards

After scorecards have been signed, signature comments can be viewed. Signed comments can be viewed by users who have the **can view scorecard signature comments** security right, assigned in Policy Editor for the scored recording.

A signed scorecard displays the View Signature button. When you click **View Signature**, the **Scorecard Signature** window displays the **Scorecard Signature Comments**.



Modify Signed Scorecards

Users who have the **Override Finished Scorecards** Security Right are allowed to modify the sign-off state and specify sign-off comments. Click **Additional Comments** to make comments.

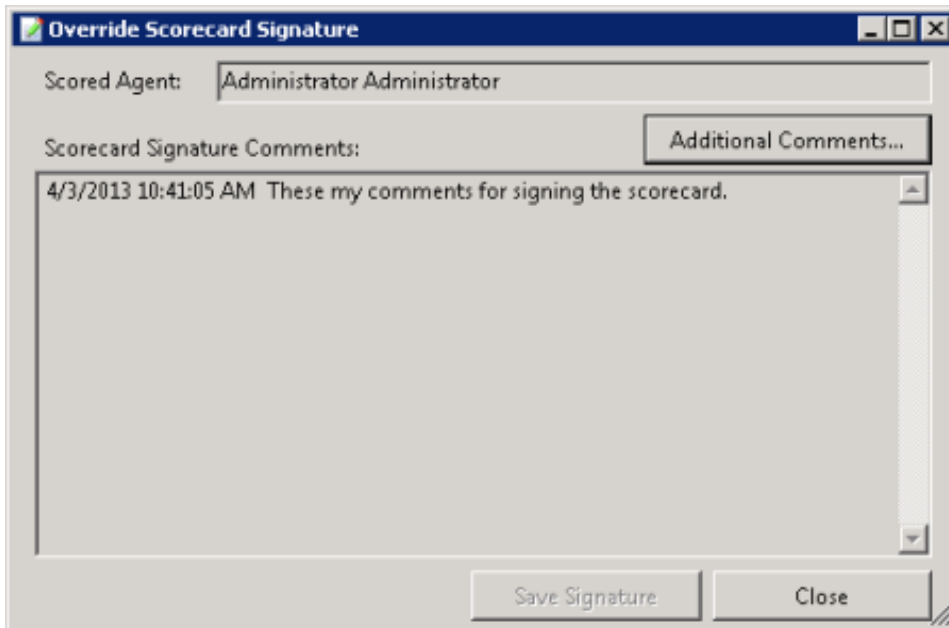

Remove Scorecard Signature

Users who have the **Override Finished Scorecards** Security Right are also allowed to remove the scorecard signature. Click **Remove Signature** to remove the signature from a scorecard. The agent will no longer be required to sign the scorecard.

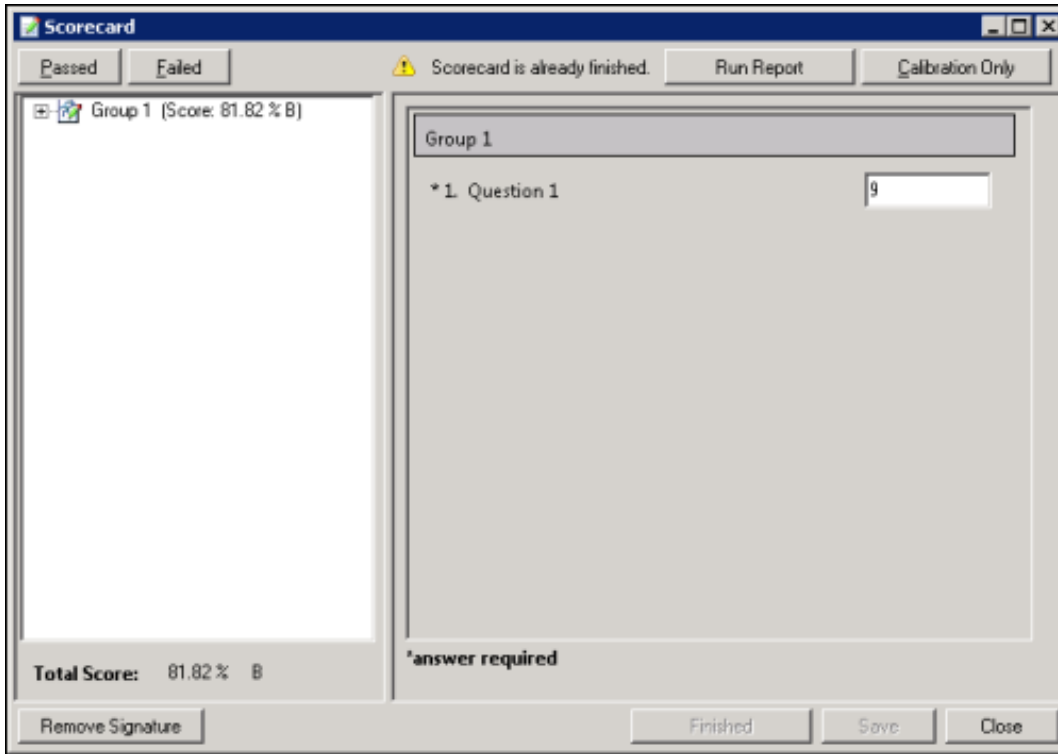

Modify Finished Scorecards

Users with the **Override Finished Scorecards** security right can modify the answers on finished scorecards and re-save the finished scorecards in the database. Users are assigned the Recorder Policy Override Finished Scorecards Security Right in Interaction Administrator. Users without this security right can only view finished scorecards.

For information on searching for and modifying finished scorecards, see [To run a scorecard search:](#)

Recording Search Results Shortcut Menu

When a recording is selected in the Search Results grid, you can right-click on the recording to display a shortcut menu.

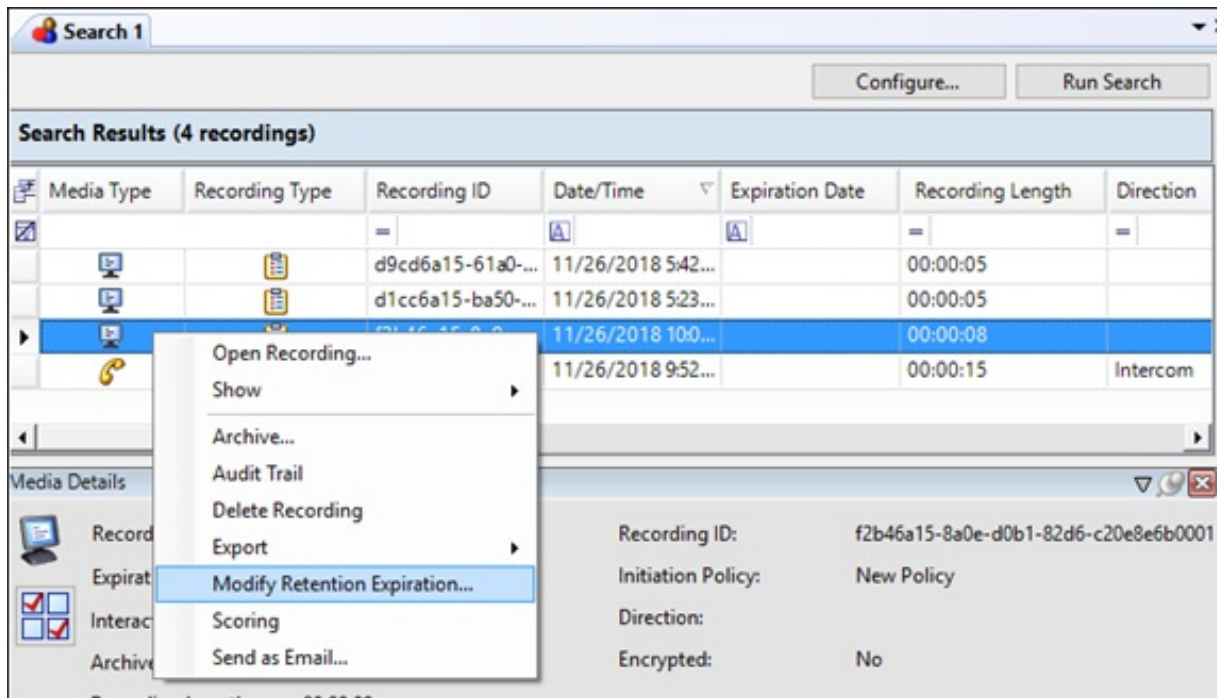

From the shortcut menu, you can:

- Open a Recording
- Show or hide the details panes
- Archive a Recording
- View the Audit Trail
- Delete a Recording
- Export a Recording or Results Rows
- Modify Retention Expiration
- Score a Recording
- Email a Recording

Open a Recording

Use the Open Recording command on the shortcut menu to open a recording in the playback dialog.

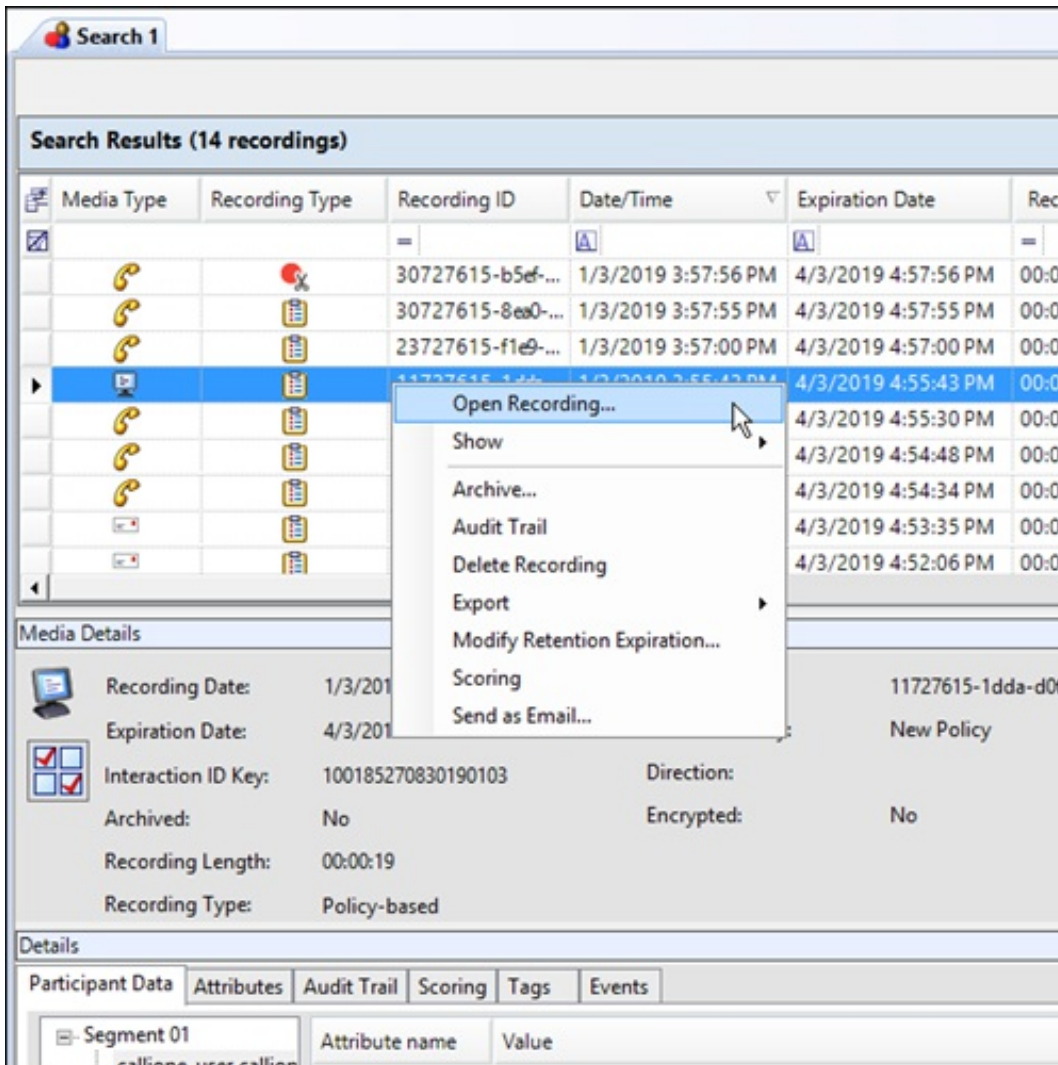

The screenshot shows a software interface with a search results table and a context menu. The table lists recordings with columns for Media Type, Recording Type, Recording ID, Date/Time, Expiration Date, and Recording Length. A context menu is open over one of the recordings, listing actions such as 'Open Recording...', 'Show', 'Archive...', 'Audit Trail', 'Delete Recording', 'Export', 'Modify Retention Expiration...', 'Scoring', and 'Send as Email...'. Below the table is a 'Media Details' section with fields for Recording Date, Expiration Date, Interaction ID Key, Archived status, Recording Length, and Recording Type. At the bottom, there are tabs for 'Participant Data', 'Attributes', 'Audit Trail', 'Scoring', 'Tags', and 'Events', with a table for 'Segment 01' showing 'Attribute name' and 'Value'.

Media Type	Recording Type	Recording ID	Date/Time	Expiration Date	Recording Length
[Phone]	[Microphone]	30727615-b5ef-...	1/3/2019 3:57:56 PM	4/3/2019 4:57:56 PM	00:00
[Phone]	[Microphone]	30727615-8ee0-...	1/3/2019 3:57:55 PM	4/3/2019 4:57:55 PM	00:00
[Phone]	[Microphone]	23727615-f1e9-...	1/3/2019 3:57:00 PM	4/3/2019 4:57:00 PM	00:00
[Phone]	[Microphone]	11727615-1dd-...	1/3/2019 3:55:43 PM	4/3/2019 4:55:43 PM	00:00
[Phone]	[Microphone]			4/3/2019 4:55:30 PM	00:00
[Phone]	[Microphone]			4/3/2019 4:54:48 PM	00:00
[Phone]	[Microphone]			4/3/2019 4:54:34 PM	00:00
[Phone]	[Microphone]			4/3/2019 4:53:35 PM	00:00
[Phone]	[Microphone]			4/3/2019 4:52:06 PM	00:00

Media Details

Recording Date: 1/3/2019
Expiration Date: 4/3/2019
Interaction ID Key: 100185270830190103
Archived: No
Recording Length: 00:00:19
Recording Type: Policy-based

Direction: [Blank]
Encrypted: No

Scoring: 11727615-1dda-d0f...
Send as Email...: New Policy

Details

Participant Data | Attributes | Audit Trail | Scoring | Tags | Events

Segment 01

Attribute name	Value
calltype	user call

When a recording is open, it is listed in the Open Recordings folder in the Navigation Pane.

Show or hide the details panes

Use the Show command on the shortcut menu to display the Details pane and Media Details pane in the Workspace, or hide the panes.

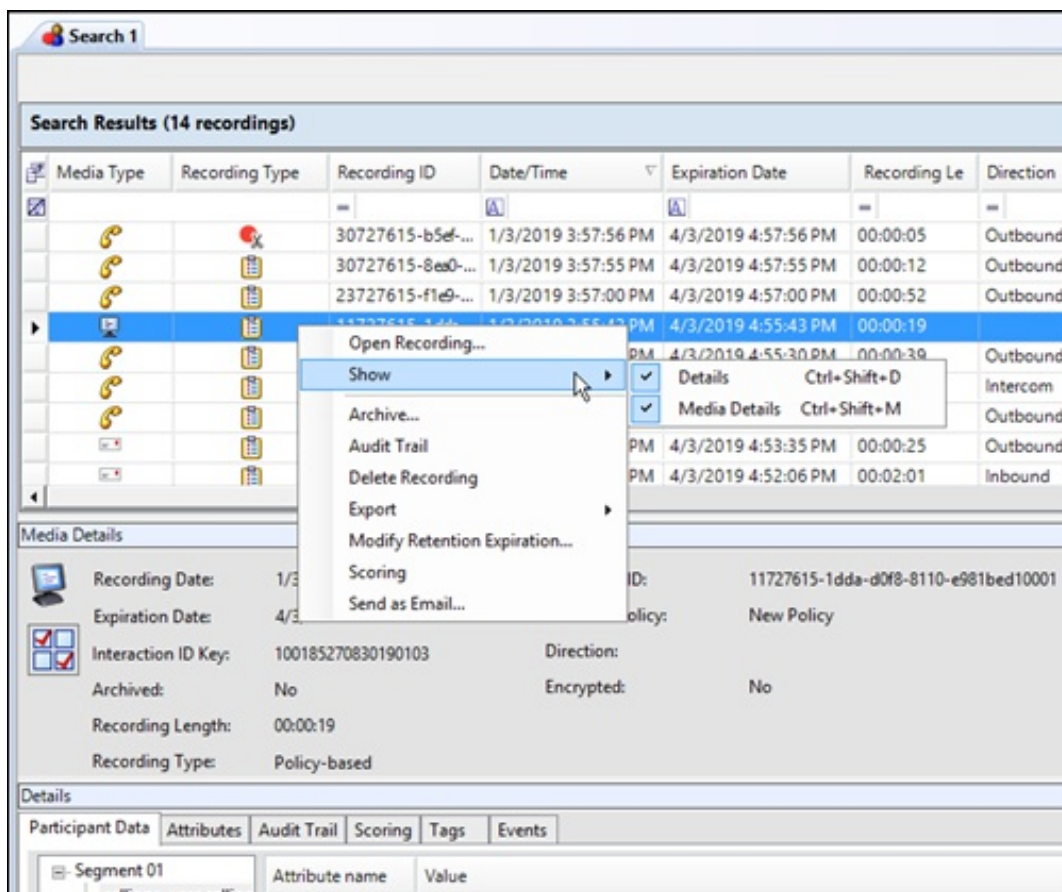

Archive a Recording

You can archive a recording from the Search Results View.

Note: To archive recordings in IC Business Manager, a user must have permission for the Security Policy [can export/archive recordings](#).

To archive a recording, select one or more recordings to be archived. Right-click the recording, and on the shortcut menu click Archive.

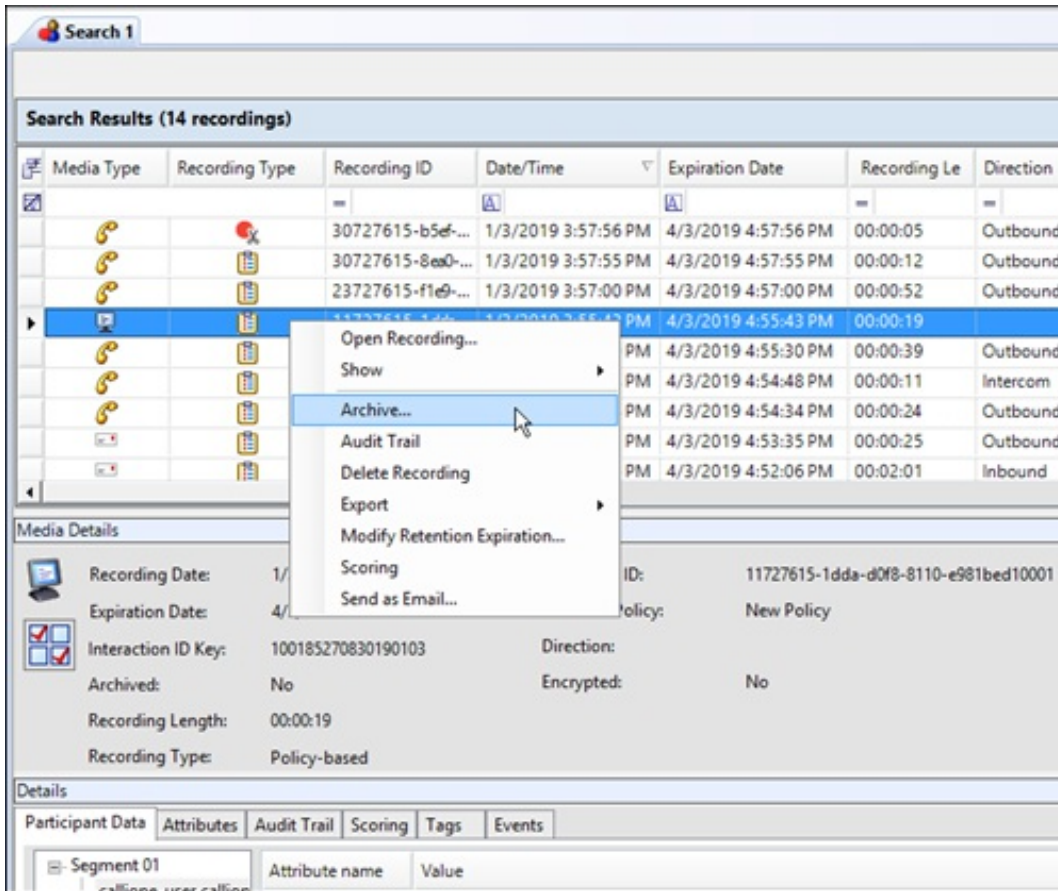

On the **Archive Recording** dialog, select a location to archive the recording from a retention policy or enter an archive storage location.

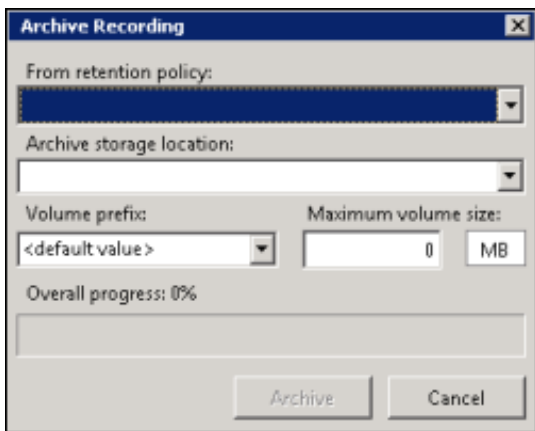

- **From retention policy**

Use this drop-down list to select a Retention Policy. This list includes the 10 most recently created policies with the Archive action. The policies are listed in order, with the most recent policy displayed first.

When you select a retention policy, the fields **Archive storage location**, **Volume prefix**, and **Maximum volume size** are populated from the retention policy. These fields can be modified for your archive.

- **Archive storage location**

All storage locations from Archive Retention Policies are listed in the drop-down list. You can select a storage location from the list or type a valid non-local shared UNC path for the storage location. In the **Volume prefix** field, you can: accept the default value for a prefix, or select a prefix from the drop-down list, or type a new volume prefix. In the **Maximum volume size** field, type the maximum storage size for each archive volume folder, and then click the **MB** box to toggle between **MB** and **GB**.

Note: When you select a **Social Media** recording to archive, the Social Media recording files are archived in a Zip format that contains the necessary files to view the recording. The playback website is also included in the Zip file.

When you have configured the Archive Recording dialog, click **Archive**. The **Overall progress** indicator displays the percentage of the archive process that has been completed.

Note: For more information on archiving recordings, see [Appendix D: Archive Recordings](#).

View the Audit Trail

Use the Audit Trail command on the shortcut menu to display information on audit events, including: Date/Time, Audit Event, User, and Comments on the event. Use the Search Results View to display the Audit Trail for a recording.

The screenshot shows a 'Search 1' window with 'Search Results (14 recordings)'. A table lists recordings with columns: Media Type, Recording Type, Recording ID, Date/Time, Expiration Date, Recording Length, and Direction. A context menu is open over one row, with 'Audit Trail' highlighted. Below the table is a 'Media Details' section with fields for Recording Date, Expiration Date, Interaction ID Key, Archived, Recording Length, and Recording Type. At the bottom is a 'Details' section with tabs for Participant Data, Attributes, Audit Trail, Scoring, Tags, and Events. The 'Audit Trail' tab is active, showing a table with columns: Date/Time, Audit Event, Audited Name, and Comments.

Media Type	Recording Type	Recording ID	Date/Time	Expiration Date	Recording Length	Direction
		30727615-b5ef-...	1/3/2019 3:57:56 PM	4/3/2019 4:57:56 PM	00:00:05	Outbound
		30727615-8ea0-...	1/3/2019 3:57:55 PM	4/3/2019 4:57:55 PM	00:00:12	Outbound
		23727615-f1e9-...	1/3/2019 3:57:00 PM	4/3/2019 4:57:00 PM	00:00:52	Outbound
				4/3/2019 4:55:43 PM	00:00:19	
				4/3/2019 4:55:30 PM	00:00:39	Outbound
				4/3/2019 4:54:48 PM	00:00:11	Intercom
				4/3/2019 4:54:34 PM	00:00:24	Outbound
				4/3/2019 4:53:35 PM	00:00:25	Outbound
				4/3/2019 4:52:06 PM	00:02:01	Inbound

The Audit Trail page is displayed in the Details pane. Use the shortcut menu from the Audit Trail page to refresh the audit trail data.

The screenshot shows the 'Details' pane with the 'Audit Trail' tab selected. The table has columns: Date/Time, Audit Event, Audited Name, and Comments. A row is selected with '12/30/2013 2:10:51 PM' and 'Play recording'. A context menu is open over the row, showing a 'Refresh Audit Trail' option with a refresh icon and the keyboard shortcut 'F5'.

Date/Time	Audit Event	Audited Name	Comments
12/30/2013 2:10:51 PM	Play recording	Administrator A	
12/30/2013 2:10:51 PM	Play recording		

Delete a Recording

Use the Search Results View to delete a recording. When a search is run, a list of recorded interactions is displayed in a grid in the Search Results View in the workspace.

To delete a recording:

1. From the Search Results View, select a recorded interaction in the Recordings grid.

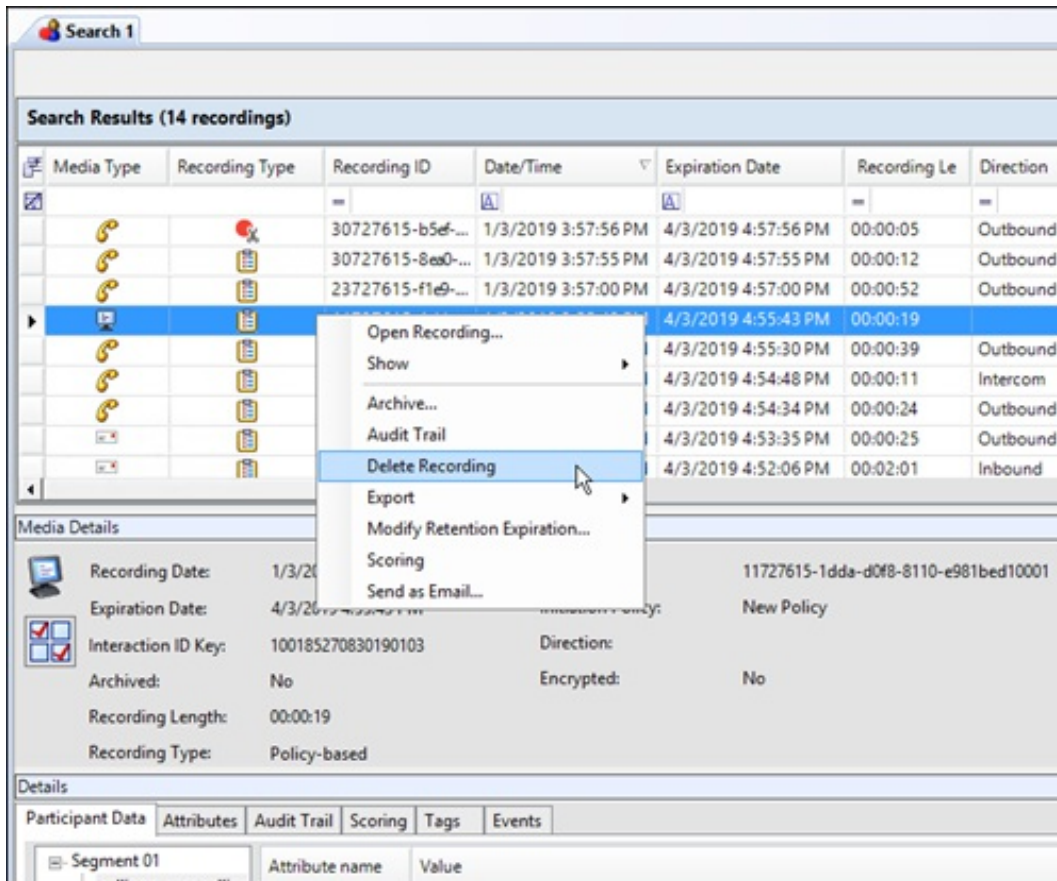

2. Right-click, and on the shortcut menu, click **Delete Recording**.

Or

After selecting the recorded interaction in the Recordings grid, press the **Delete** key.

3. A message is displayed, requesting your confirmation to delete the recording.

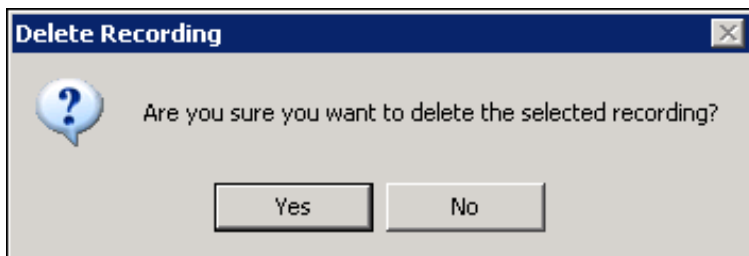

To delete the recording, click **Yes**.

Note: If there is a Screen Recording related to the recording you are deleting, you will be prompted to delete the related Screen Recording.

Export a Recording

You can Export a single recording or you can [export multiple recordings](#). The following information is for exporting a single recording.

Note: To export recordings in ICBusiness Manager, a user must have permission for the Security Policy [can export/archive recordings](#).

Export a Single Recording

To export a single recording:

1. From the Search Results View, select the recording to be exported.
Note Screen recordings are exported during Screen Recording Playback. If a screen recording is included in a recording selection, the Export menu item is not available.
2. Right-click the recording, and on the shortcut menu point to **Export**.

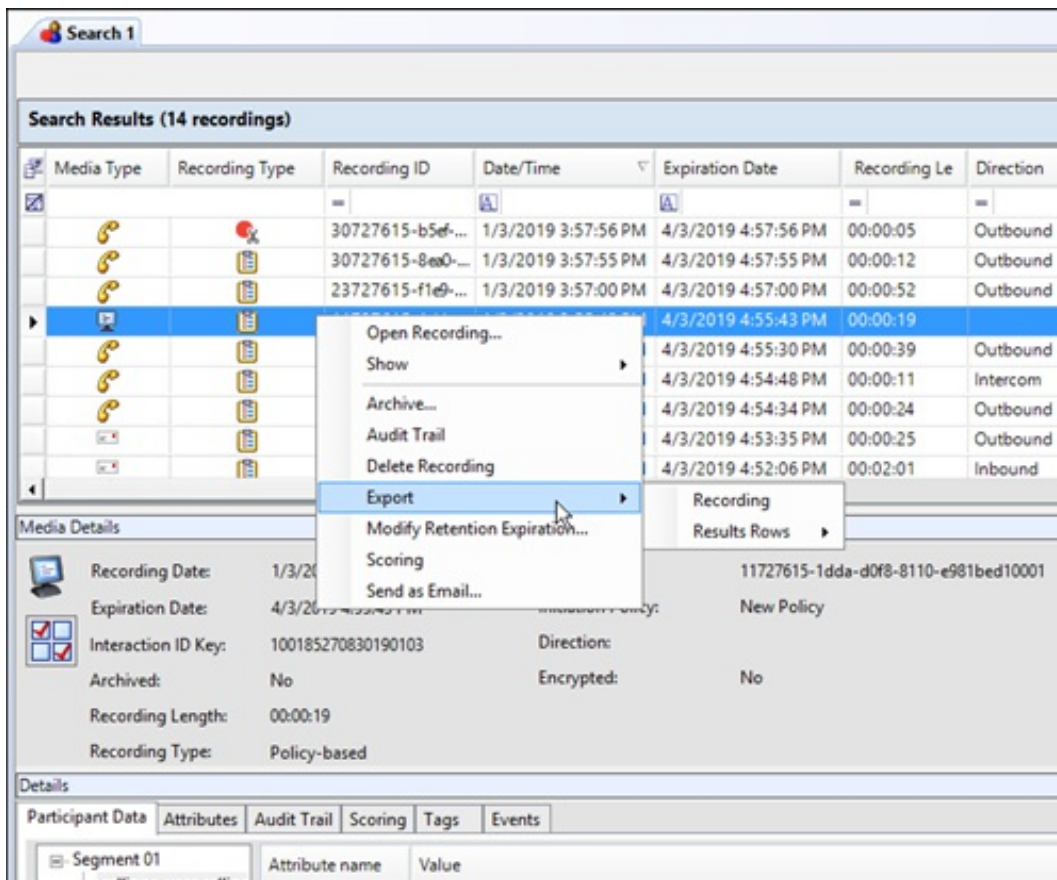

3. On the submenu, click **Recording**.

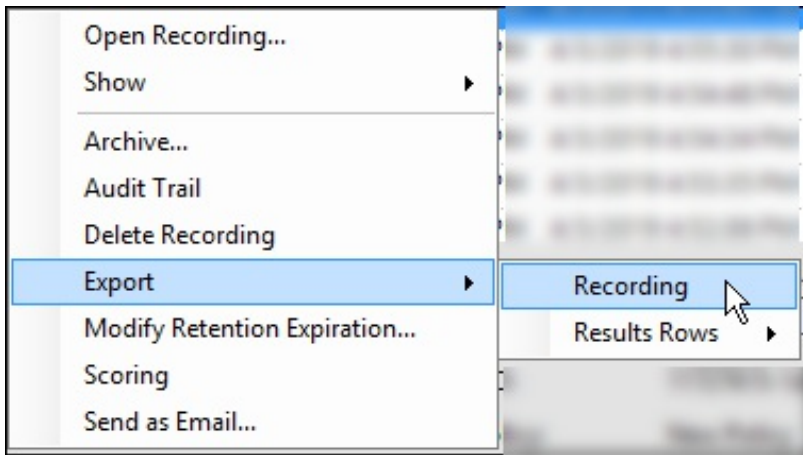

4. On the Export Recording As dialog, select the folder to export the recording to. You can also rename the file in the File name field.

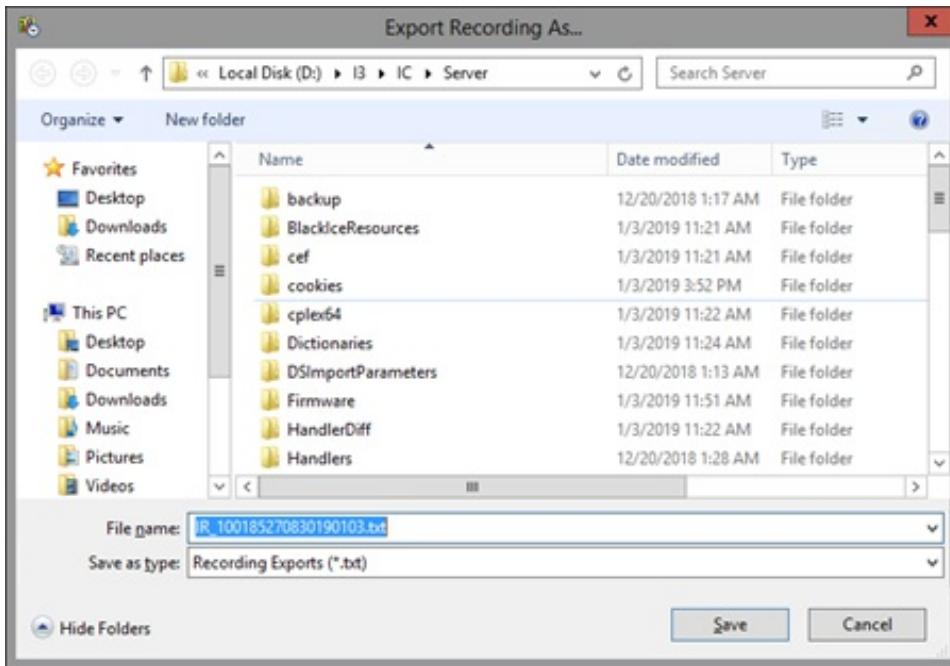

Notes

- When Social Media recordings are exported from Interaction Recorder in IC Business Manager, the files are exported in Zip format and contains the necessary files to view the recording. The playback website is included in the Zip file.
- When Opus recordings are exported from Interaction Recorder in IC Business Manager, the extracted Opus audio data is extracted into an Opus, ogg-based audio file with the .opus file extension. During export, the number of channels are maintained so that Opus Mono recordings are exported with 1 channel audio data, and Opus Dual-channel recordings are exported with 2 channel audio data.
- When μ -law, True Speech, and GSM 6.1 recording compression formats are exported from within the Recorder module in IC Business Manager, the audio data is exported as a WAV file.

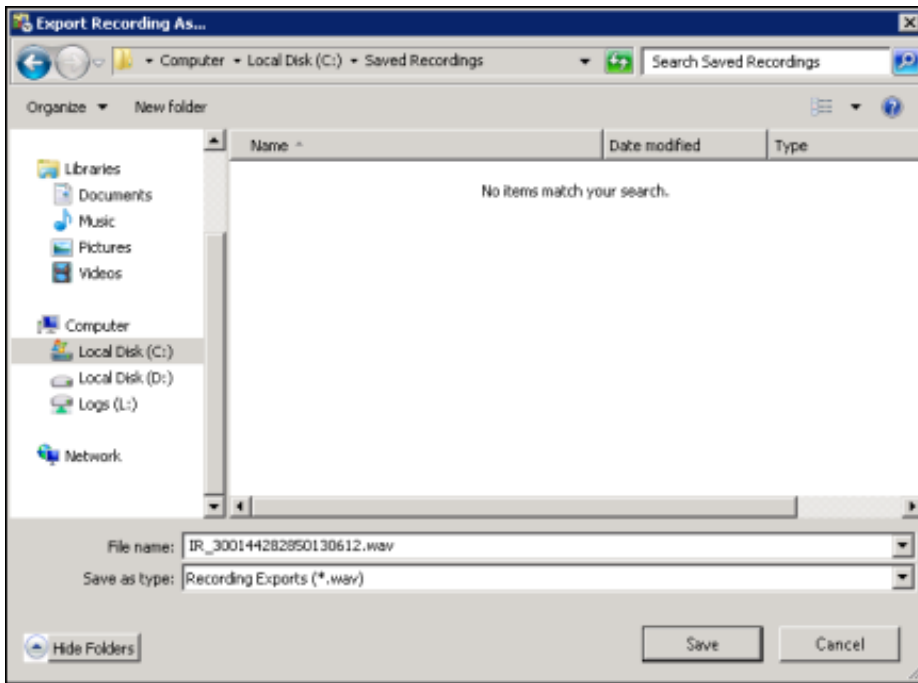

When you click **Save**, the recording is saved to the selected folder.

Export Multiple Recordings

Export multiple recordings using the Export dialog. Follow these steps to export multiple recordings to a folder.

Note

To export recordings in ICBusiness Manager, a user must have permission for the Security Policy can export/archive recordings.

To export multiple recordings from the Search Results View:

1. Select the recordings to be exported.

Note Screen recordings are exported during Screen Recording Playback. If a screen recording is included in a recording selection, the Export menu item is not available.

2. Right-click on the selection, and on the shortcut menu point to **Export**.

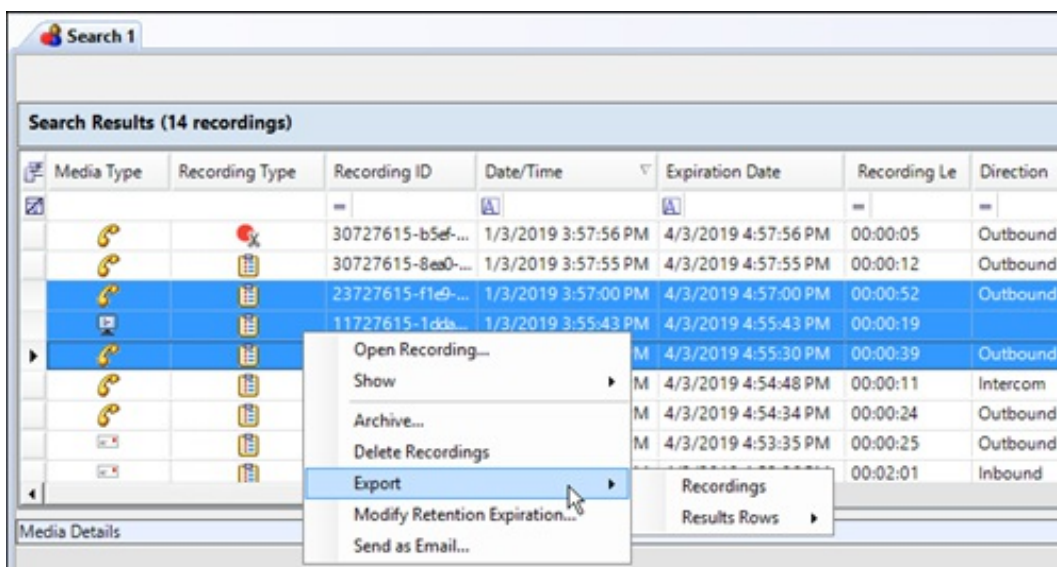

3. On the submenu, click **Recording**.

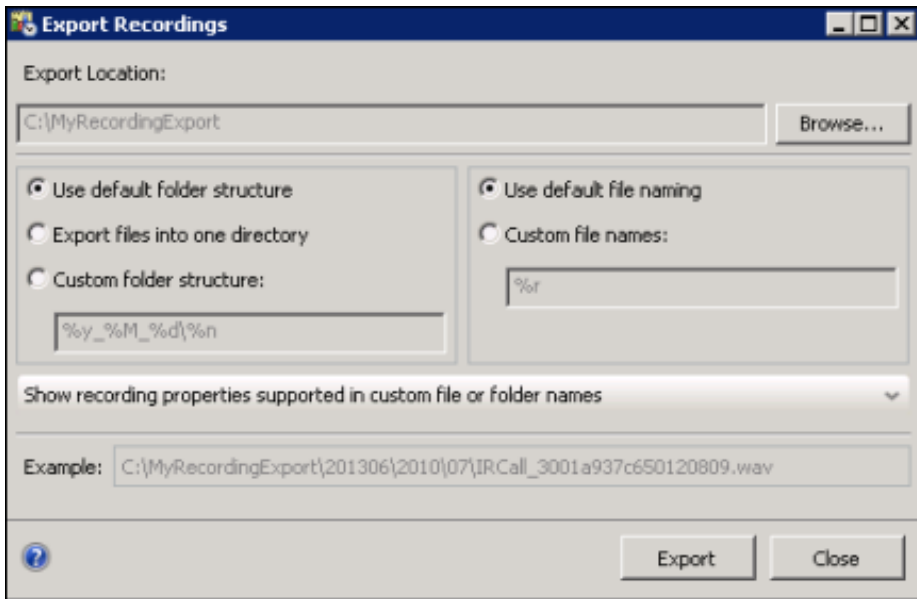
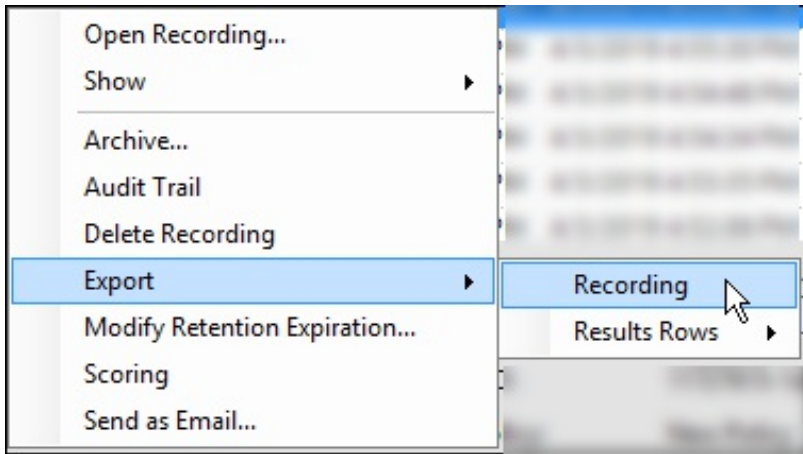

4. Use the Export Recordings dialog to specify the folder and the file names when exporting multiple recordings.

Note: When Social Media recordings are exported from Interaction Recorder in IC Business Manager, the files are exported in Zip format and contains the necessary files to view the recording. The playback website is included in the Zip file.

For	Do this:
Specify the Folder Structure	<p>First, use Browse to specify an Export Location for the root folder.</p> <p>Next, select a button to specify one relative location for the exported recordings. The choices are:</p> <ul style="list-style-type: none"> • Use default folder structure • Export files into one directory • Custom folder structure
Use default folder structure	<p>Select Use default folder structure to export the selected recordings to the specified Export Location. The recordings are saved in a directory structure in the form YYYYMM/DDHH/MM, where:</p> <ul style="list-style-type: none"> • YYYYMM is the year and month of the recording • DDHH is the day and hour of the recording <p>MM is the minute of the recording</p>
Export files into one directory	Select Export files into one directory to export the selected recordings to the root folder.
Custom folder structure	<p>Select Custom folder structure to export the selected recordings to directories defined by a directory template. The directory template is created using the properties of the exported recordings.</p> <p>After you select Custom folder structure, use the default template displayed in the Custom folder structure field, or use the Custom folder structure field to specify a new folder template. Use the Show recording properties supported in custom file or folder names drop-down list to display a description of the Key and Value properties.</p> <p>The Example field displays an example of the folder structure that is created using the template in the Custom folder structure field.</p>
Specify the file names	<p>After the relative location for the exported recordings is selected and configured, specify how the recordings files are named. The choices are:</p> <ul style="list-style-type: none"> • Use default file naming • Custom file names
Use default file naming	<p>Select Use default file naming to name the recording files by using the default naming convention.</p> <p>The recordings are named in the form IR[type of interaction]_[interaction ID].wav.</p> <p>For example, IRCall_300144281850130611.wav.</p>
Custom file names	<p>Select Custom file names to name the recording files using a file name template. After you select Custom file names, use the default template displayed in the Custom file names field or use the Custom file names field to specify a new file name template. Use the Show recording properties supported in custom file or folder names drop-down list to display a description of the Key and Value properties.</p> <p>The Example field displays an example of the file name that is created using the template in the Custom file name field.</p>

Export Recordings

When the Export Recordings dialog is complete, click **Export** to export recordings to the specified directory.

Export Results Rows

Export the contents of search results into a CSV, Excel, or PDF file. Export **All** search results rows, or **Selected Rows**.

Follow these steps to export **All** rows from the search results grid:

1. Right-click on any search results row and on the shortcut menu point to **Export**.
2. On the submenu, point to **Results Rows**, and then point to **All**.

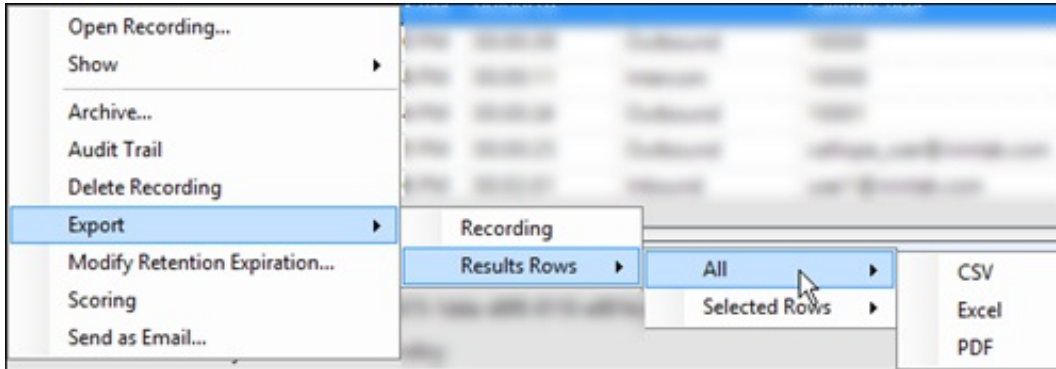

3. Select the file type for the exported file.
4. On the Save As dialog, select the folder to export the Results Rows to, and type a File name.

Follow these steps to export **Selected Rows** from the search results grid:

1. Select the search results rows to be exported.
2. Right-click on the selected rows, and on the shortcut menu point to **Export**.
3. On the submenu, point to **Results Rows**, and then point to **Selected Rows**.

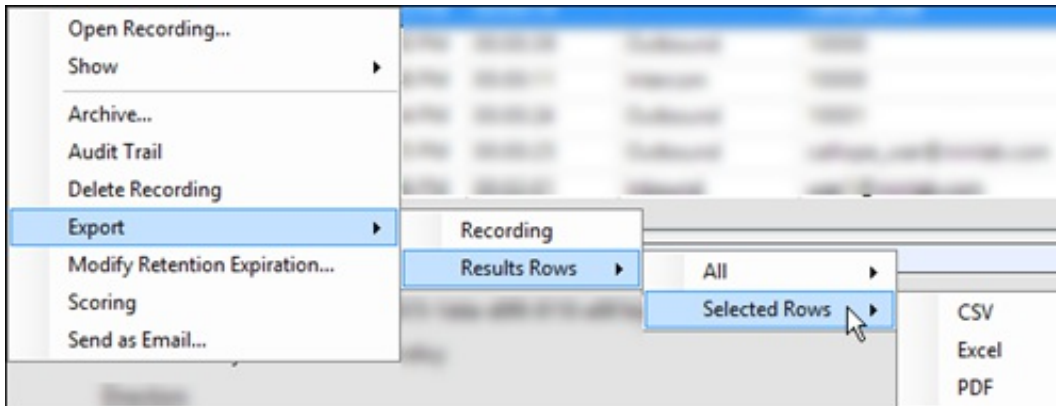

4. Select the file type for the exported file.
5. On the Save As dialog, select the folder to export the Selected Rows to, and type a File name.

Modify Retention Expiration

Retention Expiration is the date a recording is re-evaluated, based on retention policies for where the recording is stored, when it should be archived, and how long it is retained. Users with the Security policy right, Modify Retention Expiration Period, can modify the retention expiration period to set the date and time for a recording to be re-evaluated in the Interaction Recorder Client, from the recording search results view.

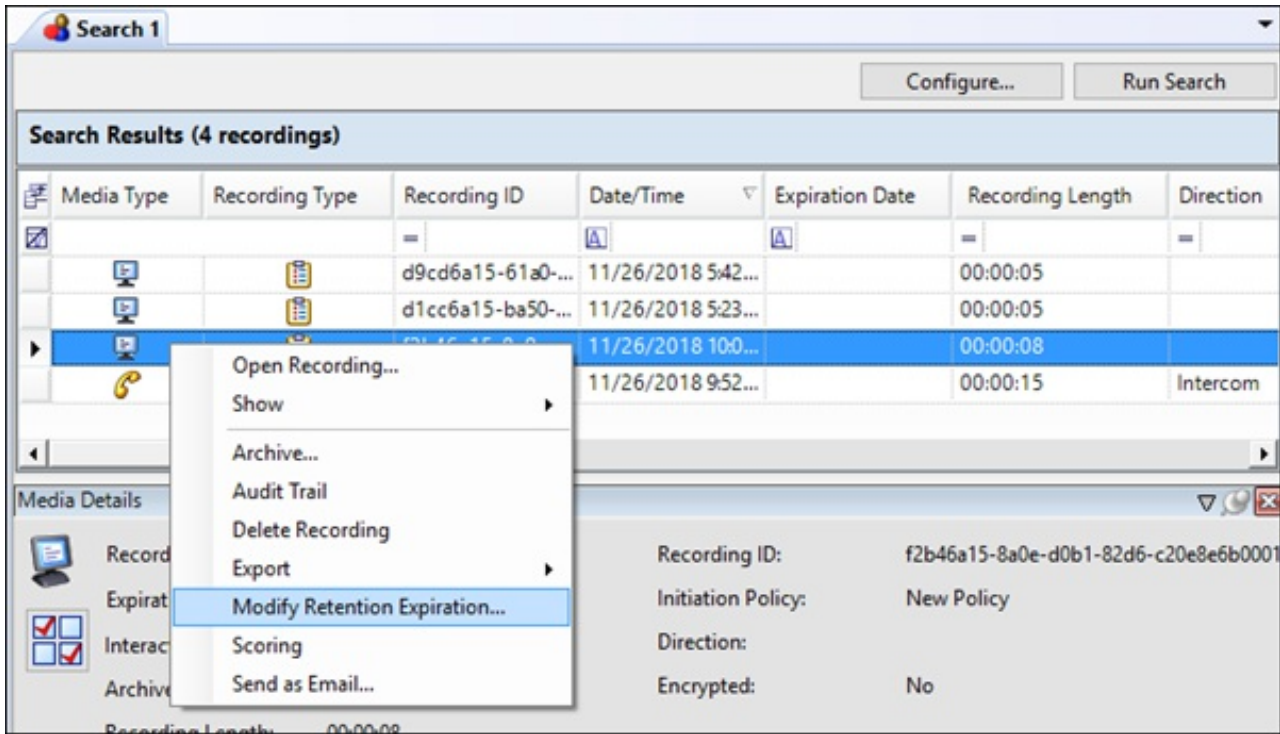

Right-click the recording, and on the shortcut menu click **Modify Retention Expiration**. The Modify Retention Expiration dialog box is displayed.

When the retention expiration is being modified for a single recording, the current expiration date of the recording is displayed.

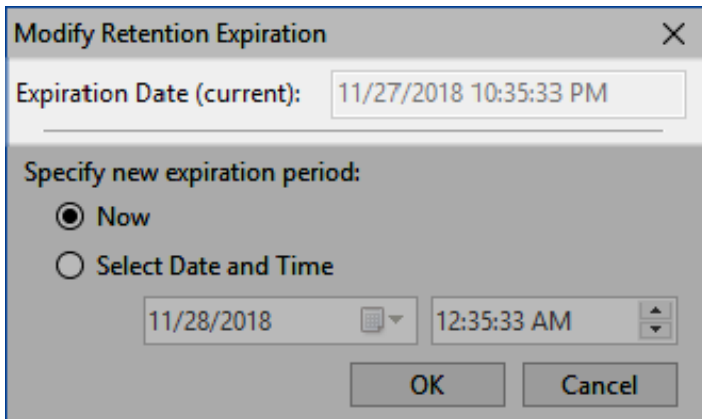

If the retention expiration is being modified for multiple recordings, the current expiration date is not displayed.

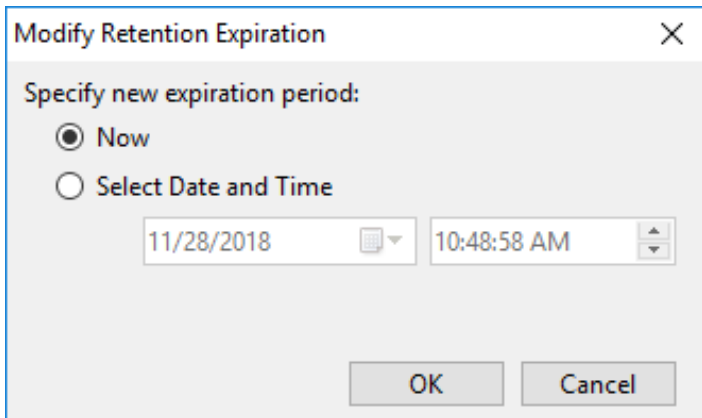

A new expiration period can be set using the **Now** button or the **Select Date and Time** button. **Now** sets the expiration to the

current date and time of the user's system. Using **Select Date and Time**, you can specify a future date and time to set as the new retention expiration date of the selected recordings. The expiration date cannot be a value in the past.

The **Expiration Date** value is updated for the recordings in the **Media Details** pane and the **Recording Search Results** grid column after the modified expiration date is set in the database.

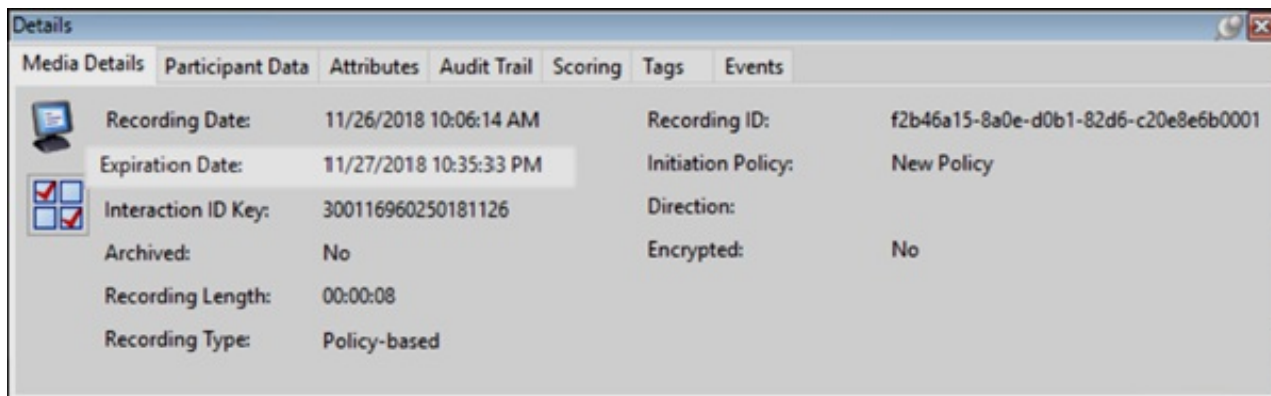

Scoring a Recording

You can score a recording from the Search Results View. Select a recording to be scored. Right-click the recording, and on the shortcut menu click Scoring.

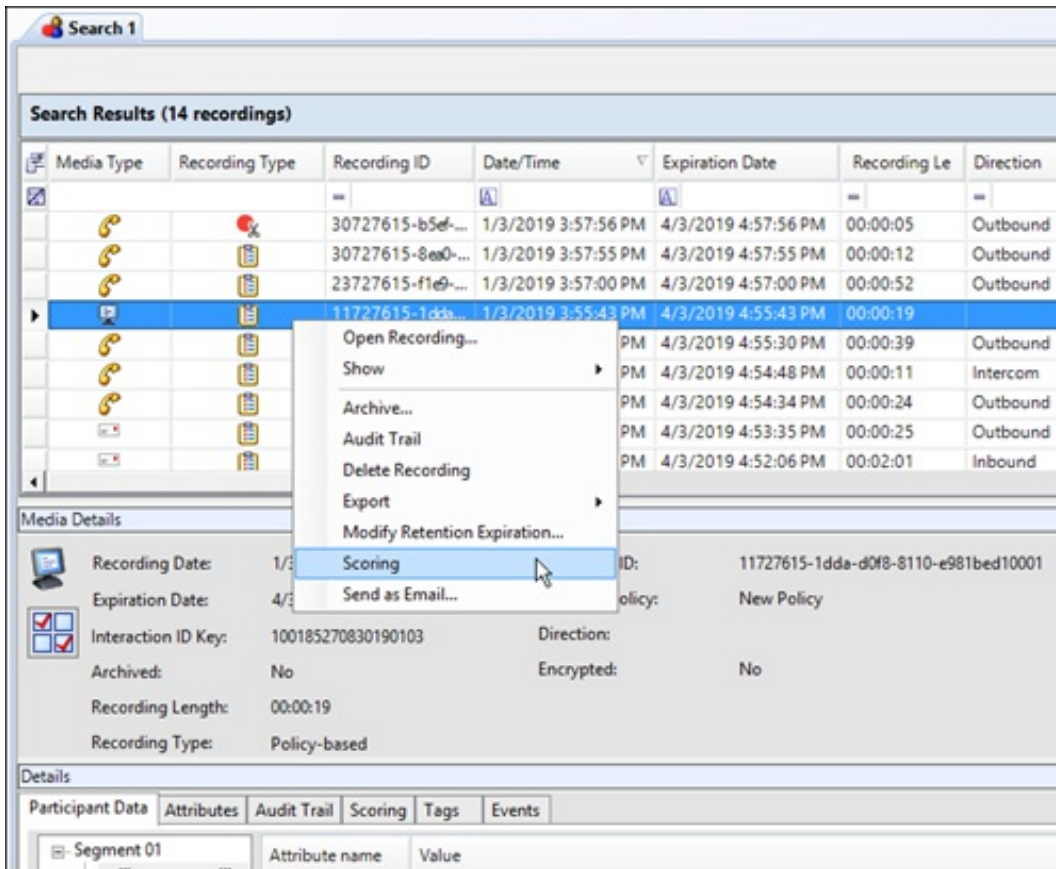

The recording is displayed in the Details pane on the Scoring page. You can add a questionnaire or score the recording in the Details pane.

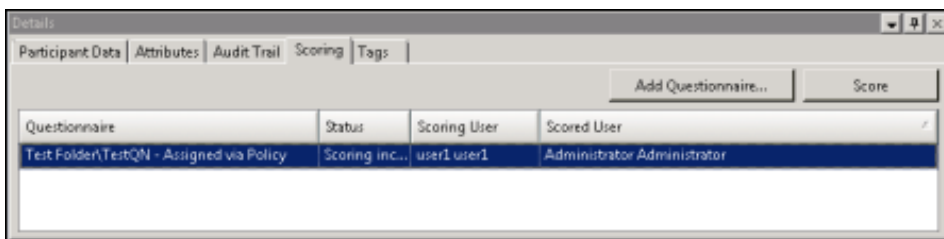

Email a Recording

You can send a recording in an email message. From the Search Results View, select the recording to be sent in an email. Right-click the recording, and on the shortcut menu click **Send as Email**.

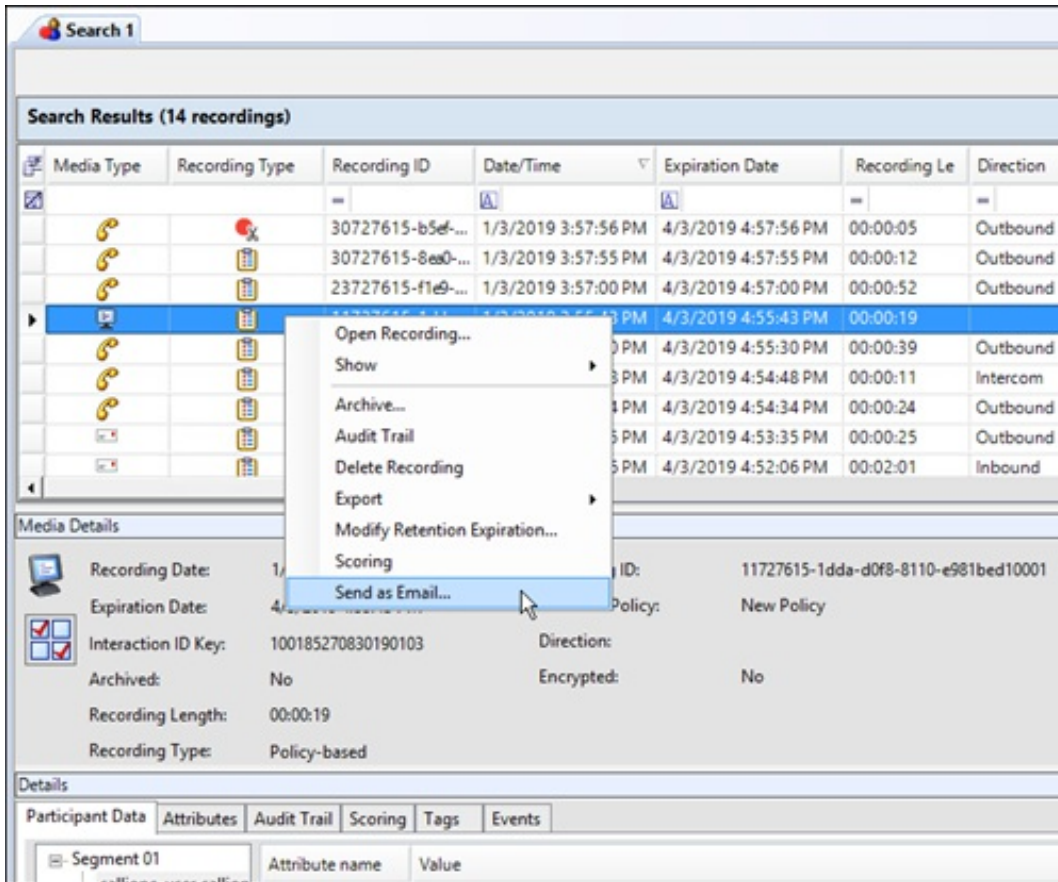

Note: You cannot email a Screen Recording. If a Screen Recording is selected in the Search Results View, when you right-click, the shortcut menu does not have the Send as Email command.

On the Send Recording Email dialog, click **To** and in the **Search For** box type an email address, and click **Add**. Add additional recipients, and when finished, click **OK**.

Note: You can configure the Reply To email address that Interaction Recorder Server uses when sending a recording from an Interaction Recorder Client. You can use the system email address or the email address of user logged in to Recorder client. For more information, see [Interaction Recorder Configuration](#).

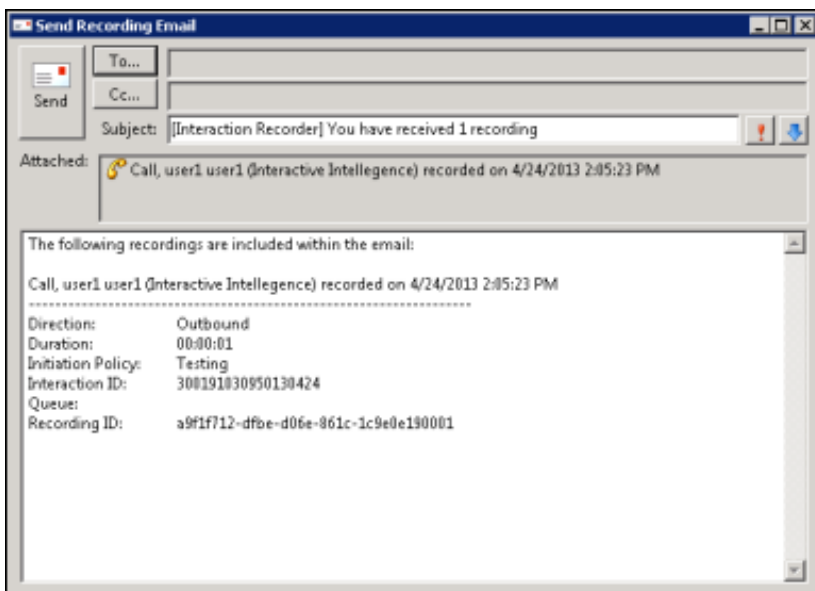

Click **Send** to send your recording.

Note: When sending an Opus recording in an email, the recording is sent as an .opus file attachment.

Note: The **Send as Email** feature for Social Media recordings might fail due to the size limit of the attachment that your email server can handle. If this occurs, the recipient of the email might not receive an error notification, but the sender of the email will receive a failed message stating the size constraint.

Run a Scorecard Search

Run a Scorecard search to display search results in a graph or a grid in the Search Results view. Scorecard search results are displayed initially in a pie chart drill-down graph.

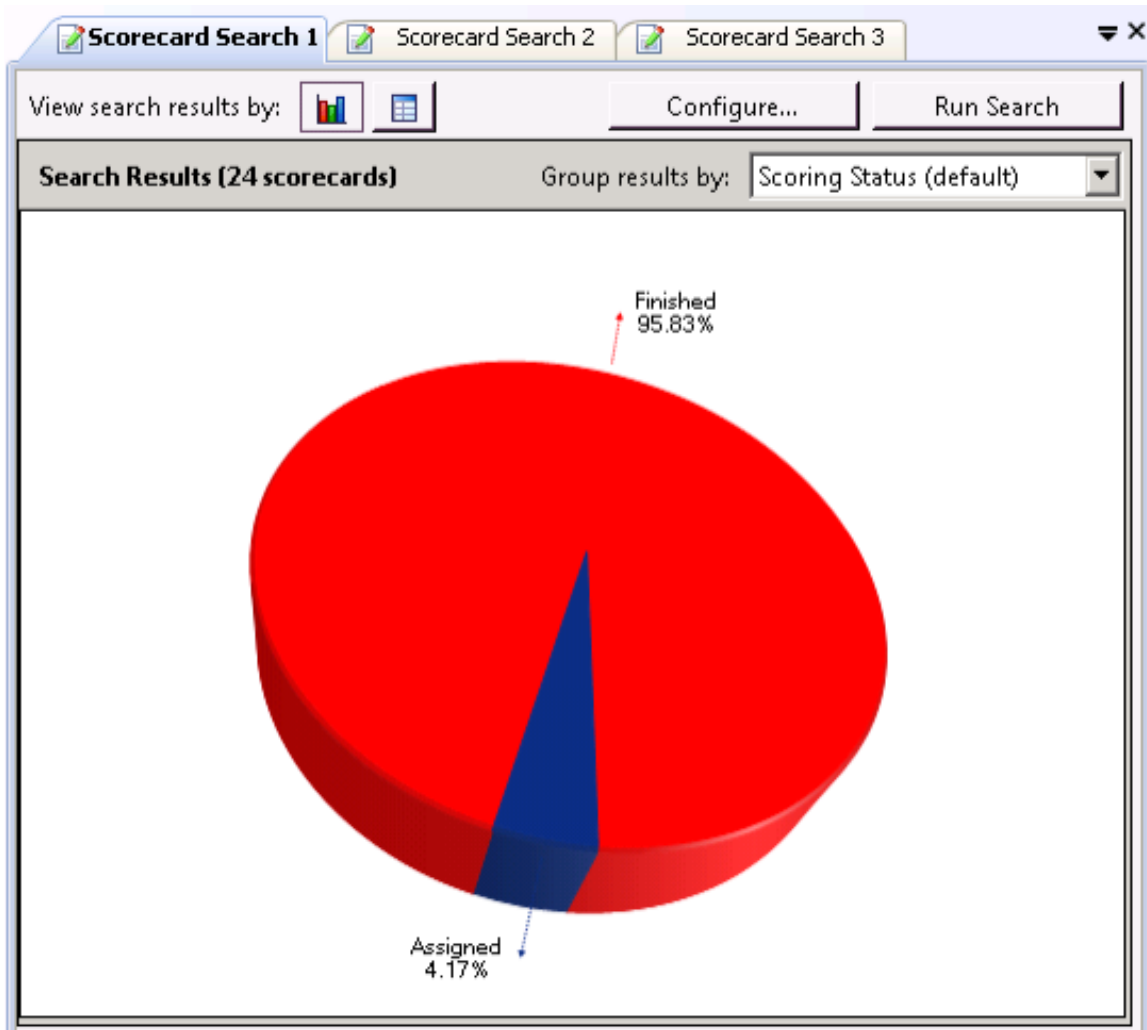

Or, scorecard search results can be displayed in a grid.

Scorecard Search 1								
View search results by:						Configure...	Run Search	
Search Results (24 scorecards)								
Scoring Date/Time	Questionnaire Directory	Questionnaire	Scoring Status	Scoring User	Scored User	Total Score	Scorecard Rating	
11/2/2012 3:52:54 P...	Quality Assurance Questionnaire Folder	QA TestQN 4	Finished	Administrator A...	user1 user1	=		
11/1/2012 4:35:17 P...	Quality Assurance Questionnaire Folder	QA TestQN 4	Finished	Administrator A...	Administrator A...	87.50 %	B	
11/1/2012 4:39:06 P...	Quality Assurance Questionnaire Folder	QA TestQN 3	Finished	Administrator A...	Administrator A...	33.33 %	F	
11/1/2012 4:29:31 P...	Quality Assurance Questionnaire Folder	QA TestQN 2	Finished	user1 user1	Administrator A...	66.67 %	D	
11/1/2012 4:25:06 P...	Quality Assurance Questionnaire Folder	QA TestQN 1	Finished	Administrator A...	Administrator A...	33.33 %	F	
10/30/2012 11:00:00...	Test Folder	Test QN 5	Finished	user1 user1	Administrator A...	71.09 %	C	
10/29/2012 2:46:25...	Test Folder	Test QN 4	Finished	user1 user1	Administrator A...	90.91 %	A	
10/25/2012 1:25:42...	Test Folder	Test QN3	Finished	user1 user1	user1 user1	86.36 %	B	
10/24/2012 4:18:20...	Test Folder	Test QN 4	Finished	Administrator A...	user1 user1	81.82 %	B	
10/23/2012 10:47:1...	Test Folder	Test QN3	Finished	user1 user1	user1 user1	86.36 %	B	
10/22/2012 2:03:45...	Test Folder	Test QN3	Finished	user1 user1	user1 user1	90.91 %	A	
10/22/2012 1:38:58...	Test Folder	Test QN3	Finished	user1 user1	Administrator A...	86.36 %	B	
10/19/2012 3:58:48...	Test Folder	Test QN	Finished	Administrator A...	Administrator A...	86.36 %	B	
10/18/2012 1:53:47...	Test Folder	Test QN3	Finished	Administrator A...	Administrator A...	63.64 %	D	
10/17/2012 10:26:1...	Test Folder	Test QN2	Finished	Administrator A...	Administrator A...	86.36 %	B	
10/12/2012 12:07:2...	Test Folder	Test QN2	Finished	Administrator A...	Administrator A...	90.91 %	A	
10/11/2012 3:51:56...	Test Folder	Test QN	Finished	Administrator A...	user1 user1	86.36 %	B	
10/11/2012 1:45:55...	Test Folder	Test QN	Finished	Administrator A...	user1 user1	86.36 %	B	
10/10/2012 11:34:3...	Test Folder	Test QN	Finished	Administrator A...	Administrator A...	86.36 %	B	
10/0/2012 6:16:01 D...	Test Folder	Test QN	Finished	Administrator A...	Administrator A...	73.73 %	C	

Specific details of scorecards can be reviewed in this view.

To run a scorecard search:

1. From the Navigation Pane, in the Searches pane, select a scorecard search.

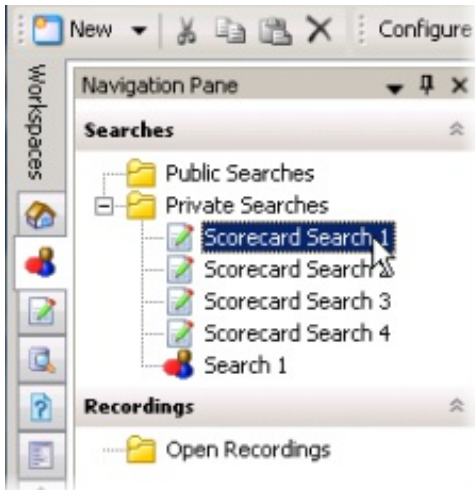

2. The search is automatically executed and the results are displayed in the workspace.

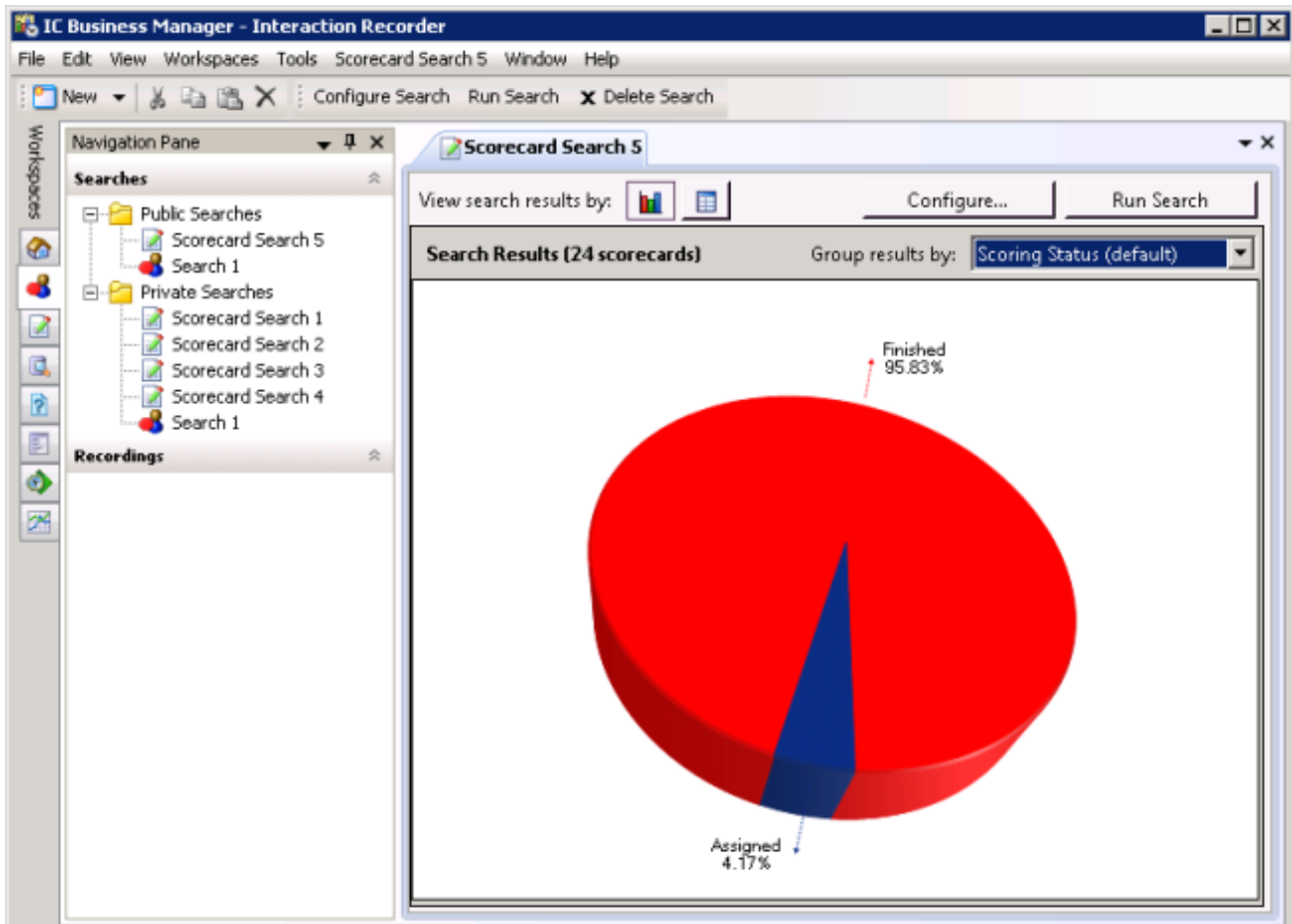

Note Here are other ways to run a search:

- From the **Searches** pane, select a search, and in the workspace click **Run Search**
- Select the search in the Searches pane, and on the menu bar click the **Search Title** Active View menu, and then click **Run Search**
- From the **Searches** pane, select a search, and click **Run Search** on the toolbar
- Select a search in the Searches pane, right-click, and on the shortcut menu, click **Run**

Save a Scorecard Search

Public and Private searches are automatically saved when they are run. If an invalid attribute field value is detected when running your search, an error message is displayed. Attribute data values are verified before a Search is run, and must contain valid data in order for the search to be saved.

When configuring a search in the SearchBuilder control, a search can be saved before running it by clicking **Save Search**. Using the Save Search button allows you to verify and save search attributes while building a search, before running it.

Edit a Scorecard Search

Edit a search to modify existing attributes or configure new search attributes. Here are different ways you can edit the search configuration:

- From the **Searches** pane, right-click on the search name, and on the shortcut menu click **Configure**. The properties of the search are displayed in the SearchBuilder control. For more information, see [Adding Attributes to a Scorecard Search](#).
- From the **Searches** pane, click the search name. The search is run and the results are displayed in the Workspace. On the Workspace, click **Configure**. The SearchBuilder control is displayed.
- You can also edit a search by selecting the search name in the Searches pane and clicking **Configure Search** on the toolbar.

View Scorecard Search Results

Based on the attributes of the scorecard search, when a search is run the results are displayed in a default pie chart in the Search Results. You can also view the search results in a grid. Click the **View search results by** buttons to switch between the grid view and graph view of your search results.

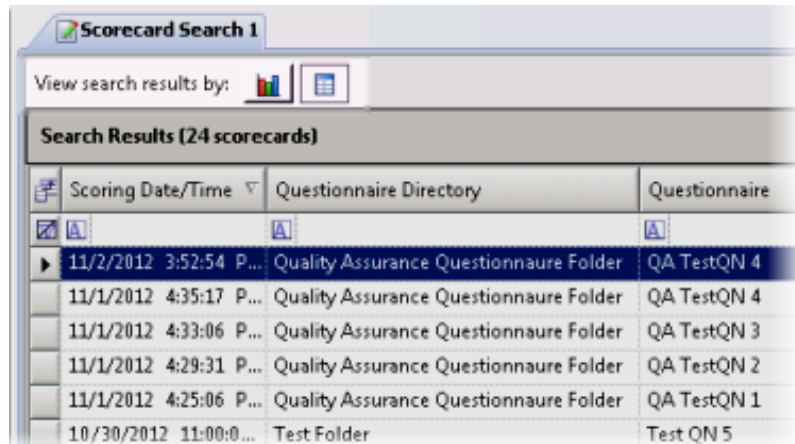

Scoring Date/Time	Questionnaire Directory	Questionnaire
11/2/2012 3:52:54 P...	Quality Assurance Questionnaire Folder	QA TestQN 4
11/1/2012 4:35:17 P...	Quality Assurance Questionnaire Folder	QA TestQN 4
11/1/2012 4:33:06 P...	Quality Assurance Questionnaire Folder	QA TestQN 3
11/1/2012 4:29:31 P...	Quality Assurance Questionnaire Folder	QA TestQN 2
11/1/2012 4:25:06 P...	Quality Assurance Questionnaire Folder	QA TestQN 1
10/30/2012 11:00:0...	Test Folder	Test QN 5

Work with Scorecard Search Results

You can work with Scorecard Search Results in a drill-down graph view or a grid view.

Scorecard Search Results Graph View

Click the **View search results by** graph button  to view all scorecards returned within the search results, displayed in a graph. Use the Search Results graph view to view and sort scorecard results based on drill-down graph data.

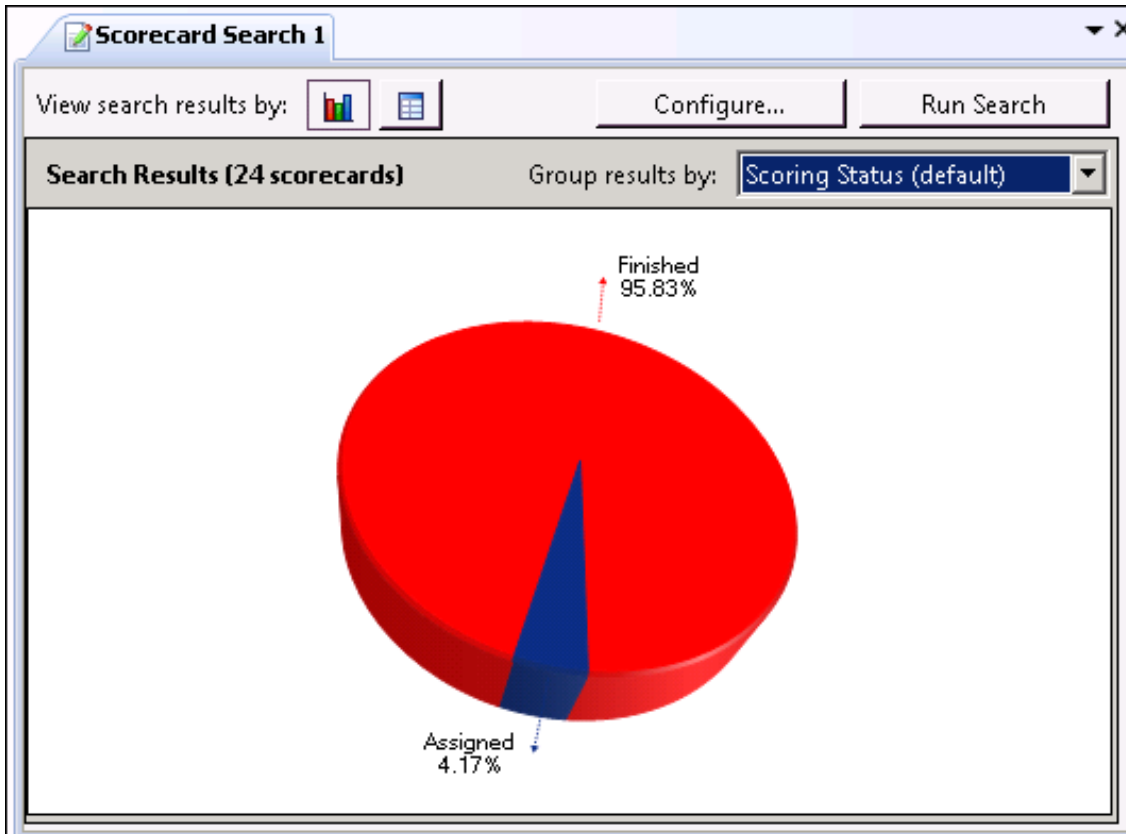

The initial default graph is a pie chart grouped by Scoring Status. When you pause the mouse on a slice of the pie, the number of scorecards for that percentage of the search results is displayed. To display the pie chart legend, right-click in the workspace and on the shortcut menu point to **View** and select **Legend**.

Use the **Group results by** drop-down list to display graphs grouped by:

- Scoring Status
- Scorecard Rank
- Scoring User
- Scored User
- Questionnaire

Here is a description of the **Group results by** options.

Group results by	Description
Scoring Status	Groups the search results by Scoring Status: Assigned, Scoring incomplete, and Finished. The graph displays the percentage of scorecards in each status.
Scorecard Rank	Groups the search results by Scorecard Rank and displays a graph showing the percentage of scorecards for each Scorecard Rank in the search results.
Scoring User	Groups search results by Scoring User and displays a graph showing the percentage of scorecards for each user that scored interactions in the search results.
Scored User	Groups search results by Scored User and displays a graph showing the percentage of scorecards for each user that was scored in the search results.
Questionnaire	Groups search results by Questionnaire and displays a graph showing the percentage of scorecards for each questionnaire in the search results.

Drill Down Graphs

Double-clicking on a slice of the pie chart displays a bar graph for selected scorecards from the search results, sorted by questionnaire name.

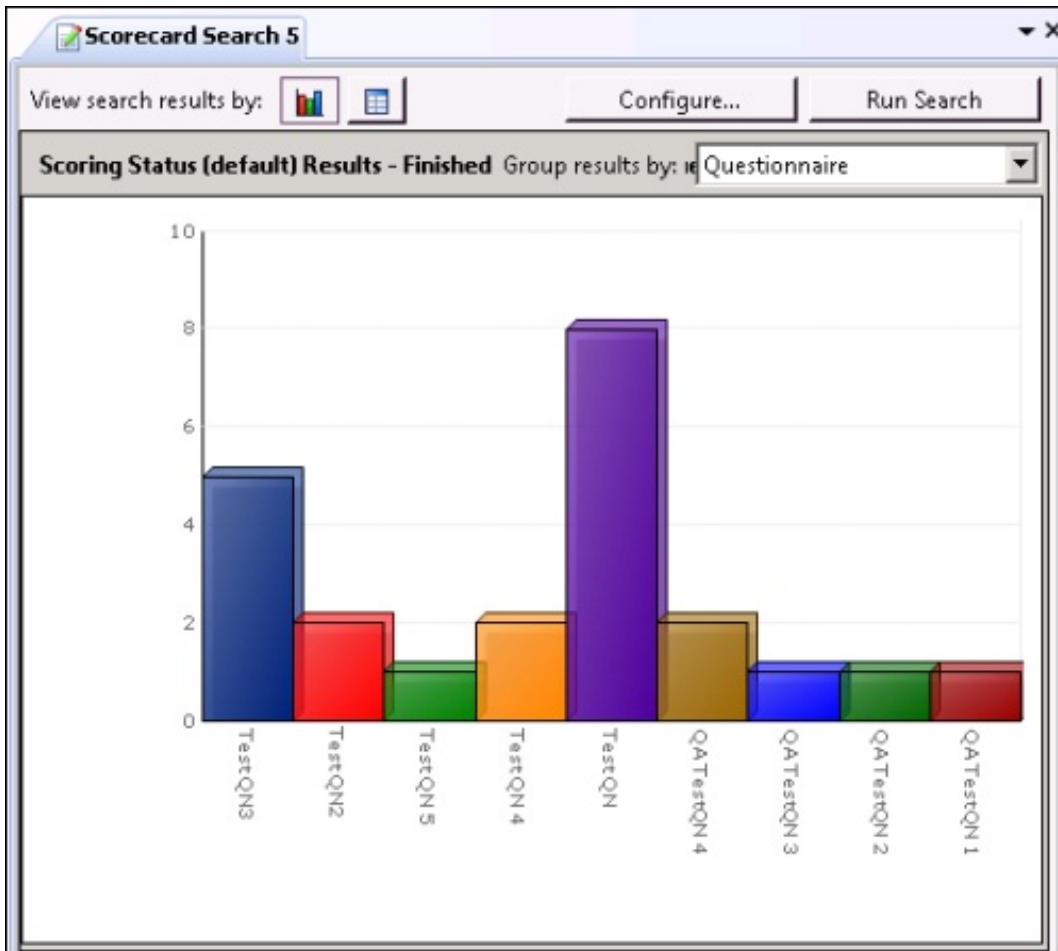

Note

When drilling down in the pie chart, if there is only one questionnaire associated with the selected recordings in the slice of pie, a bar graph will not be displayed, and a data grid containing the selected scorecards is displayed instead.

When you pause the mouse on a questionnaire bar in the graph, the number of scorecards for that questionnaire in the search results is displayed.

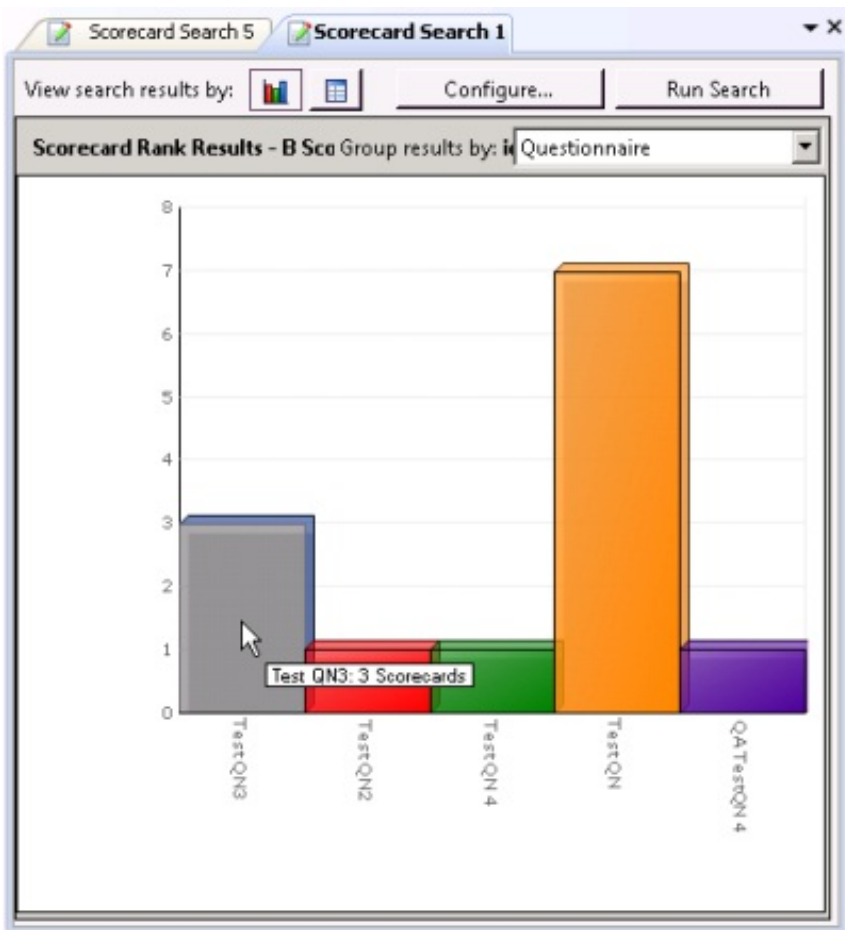

Double-clicking on a questionnaire bar in the graph displays a data grid that includes the information for the scorecards that used that specific questionnaire.

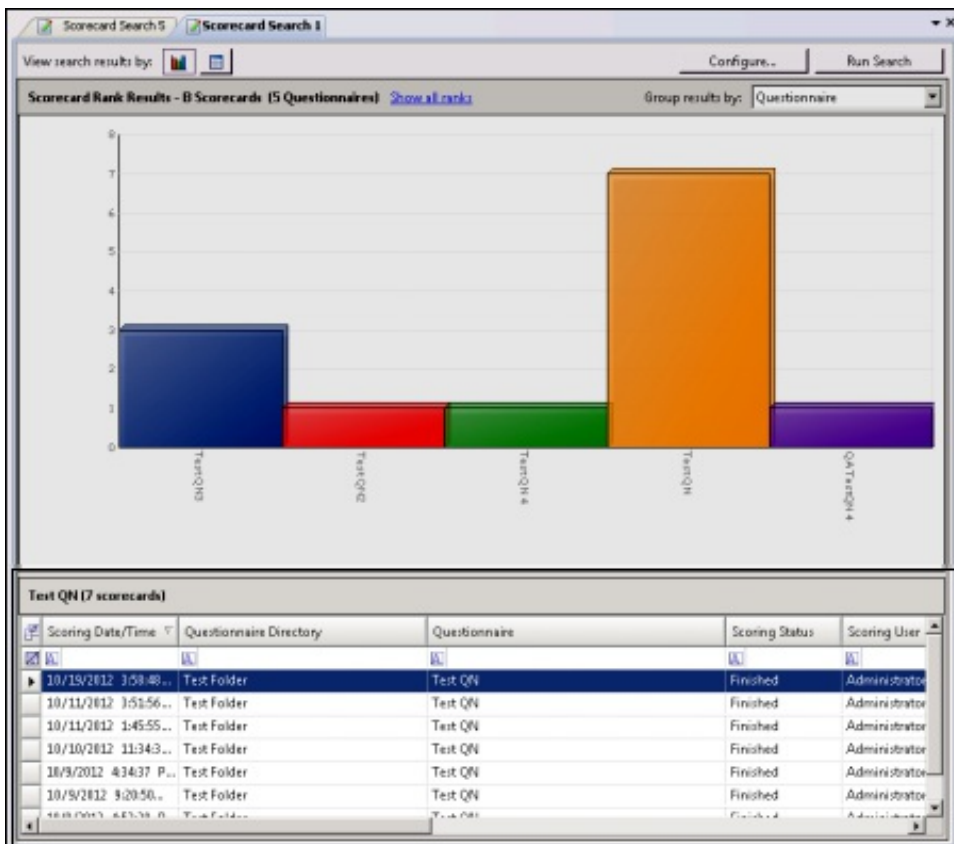

For information on using the data grid, see [Scorecard Search Results Grid View](#).

Show All link

From the bar graph view, to return to a pie chart view, click **Show All** in the graph title bar. For example, in a bar graph for **Scorecard Rank Results**, click **Show all Ranks** to return to the pie chart.



View All

From the bar graph view, to display all the scorecard information for the scorecard represented in the graph, in the **Group Results** by drop-down list, click **View All**. The scorecard information is displayed in a data grid.

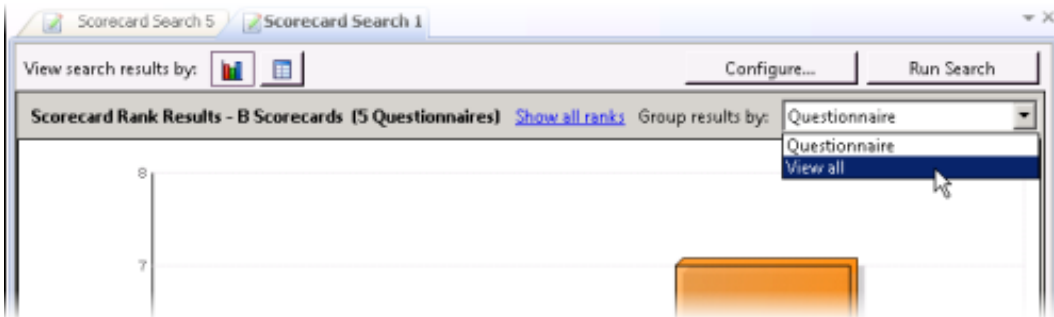

Scorecard Search Results Grid View



Click the **View search results by grid** button  to view all scorecards returned within the search results in a grid in the workspace. Use the Search Results grid view to review the details of a scorecard listed in the grid, open a recording for playback, open a scorecard, or run the Quality Scorecard report.

Viewing Scorecard Details

The results of a scorecard search are displayed a grid in the workspace. The grid displays a list of scorecards, by **Scoring Date/Time** that are found for the search, in descending order (newest to oldest). The Scoring Date/Time field includes the date the scorecard was assigned to a recording or dates associated with a scorecard that is in progress or finished.

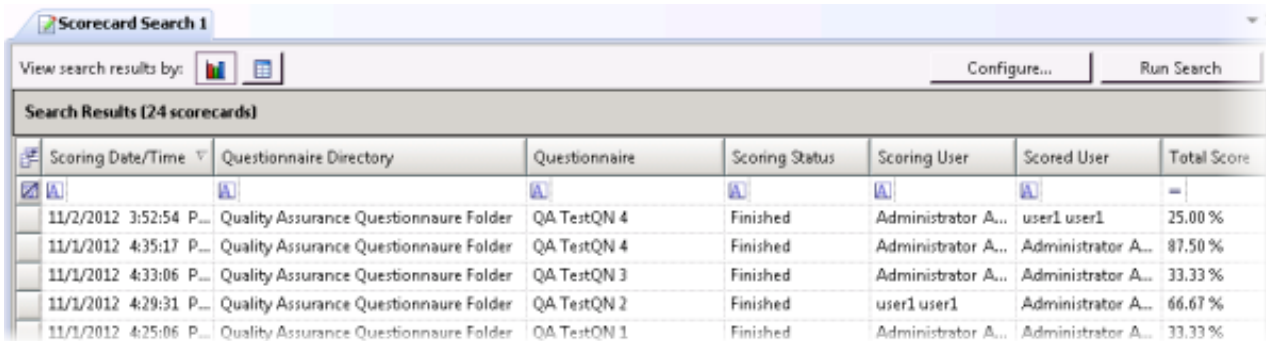

The screenshot shows a window titled "Scorecard Search 1" with a toolbar containing "View search results by:" (with icons for list and table), "Configure...", and "Run Search". Below the toolbar is a table with the following data:

Scoring Date/Time	Questionnaire Directory	Questionnaire	Scoring Status	Scoring User	Scored User	Total Score
11/2/2012 3:52:54 P...	Quality Assurance Questionnaire Folder	QA TestQN 4	Finished	Administrator A...	user1 user1	25.00 %
11/1/2012 4:35:17 P...	Quality Assurance Questionnaire Folder	QA TestQN 4	Finished	Administrator A...	Administrator A...	87.50 %
11/1/2012 4:33:06 P...	Quality Assurance Questionnaire Folder	QA TestQN 3	Finished	Administrator A...	Administrator A...	33.33 %
11/1/2012 4:29:31 P...	Quality Assurance Questionnaire Folder	QA TestQN 2	Finished	user1 user1	Administrator A...	66.67 %
11/1/2012 4:25:06 P...	Quality Assurance Questionnaire Folder	QA TestQN 1	Finished	Administrator A...	Administrator A...	33.33 %

Note

The Scoring User column displays the names of the users that scored the individual recordings displayed in the Search Results grid. If the user, viewing the Search Results, has the **Can Score Recordings** Security Policy rights for a recording, the Scoring User name is displayed in the Scoring User column. If the user does not have the **Can Score Recordings** policy rights for the recording, the scorecard is not displayed in the search results.

To paste recording information into another application, use Ctrl+C in the grid to Copy an entire row, or multiple rows, to the clipboard.

Selecting Fields for the Scorecard grid

To change the Fields that are displayed in the grid, click the **Field Chooser**  on the upper left of the grid. The Show/Hide Columns dialog is displayed.

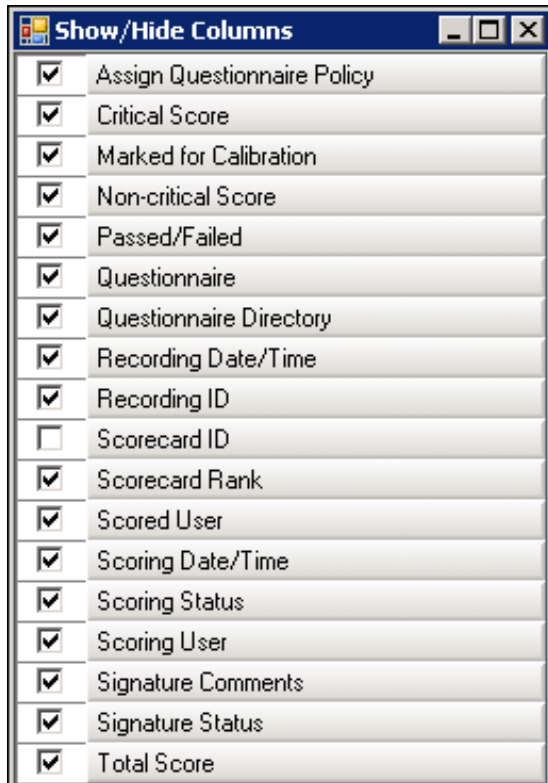

In the **Show/Hide Columns** dialog, select the Fields to display in the grid.



Sorting columns in the grid

To sort a grid column in ascending or descending order, click the Field name.

Refining search results

To further refine the search results, use the Filter Criteria selection fields  below each Field. To create a field filter for the search results displayed in the grid, select the field below the Field name. The field search filter is displayed. To select an operand for the search, click . In the drop-down list, select the search criteria. Depending on the field and your selections, an additional dialog might be displayed. The search results are displayed according to your search filter. To clear the filter criteria, in the field click .

To clear *all* filter criteria, click  at the left on the Filter Criteria selection fields grid row.

Scorecard Search Results Shortcut Menu

When a scorecard is selected in the Search Results grid, you can right-click on the scorecard to display a shortcut menu.

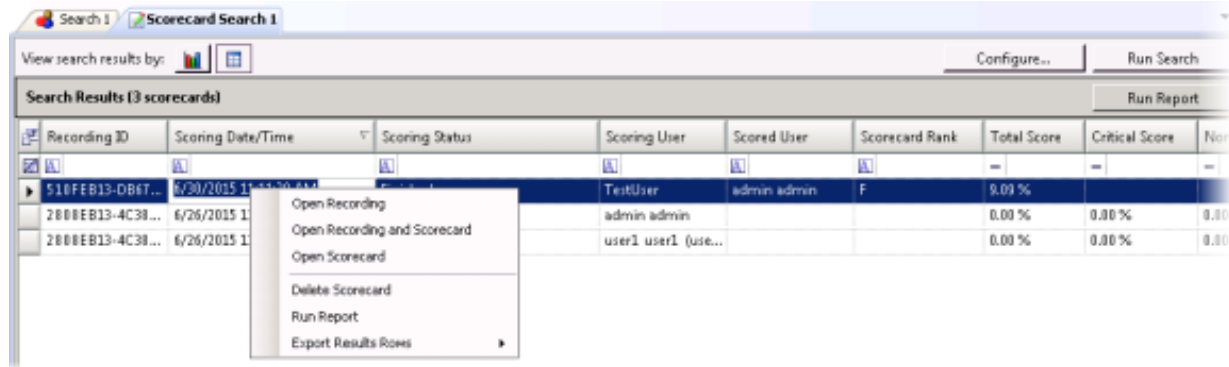

From the shortcut menu, you can:

- Open a recording
- Open a recording and a scorecard
- Open a scorecard
- Delete a Scorecard
- Run a report
- Export Results Rows

Open a Recording

To open a recording associated with a scorecard, in the grid right-click on the scorecard and on the shortcut menu, click **Open Recording**. A media player displays the recording.

Open a Recording and a Scorecard

To open a scorecard and its associated recording, in the grid select the scorecard. Right-click on the scorecard, and on the shortcut menu click **Open Recording and Scorecard**. The scorecard is displayed and the media player displays the recording.

Open a Scorecard

To open a scorecard from the grid, double-click the scorecard in the list. The scorecard is displayed. You can also open the scorecard from the shortcut menu.

Note

When multiple internal participants are associated with a scorecard's recordings, the Select Agent dialog is displayed.

Delete a Scorecard

To delete a scorecard from the grid, select the scorecard. Right-click on the scorecard, and on the shortcut menu click **Delete Scorecard**.

Quality Scorecard Report

A Quality Scorecard Report includes the information contained in the current scorecard, displayed in a report format. Quality Scorecard reports can be generated from the scorecard results grid, from a scorecard, and can also be generated from the recording search results in the Details pane.

Run a Quality Scorecard Report

You can generate a report on a Finished Scorecard. To generate a report with the details for a scorecard, in the grid right-click on the scorecard and on the shortcut menu, click **Run Report**. The Quality Scorecard report is displayed in the workspace, and it includes all the details of the scorecard.



Quality Scorecard

Questionnaire Details		Interaction Details	
Questionnaire Directory:	Questionnaire1	Media Type:	Chat
Questionnaire Name:	Customer Service	Recorded Date:	8/23/2017 2:43:07 AM
		Recording ID:	8886dd14-5283-d0fa-868d-804fe5eb0001
		Interaction ID Key:	100178840650170823
		Initiation Policy:	New Policy
		Recording Length:	00:01:44
		Direction:	

Scorecard Details			
Marked for Calibration Purposes		Scorecard State:	Finished
Scorecard Date:	8/23/2017 2:46:53 AM	Scorecard Score:	73.91% (C)
Scored User:	donatella_user donatella_user		
Scoring User:	donatella_user donatella_user		

Intro/Greeting		Group Score:			
Question:	Answer:	73.91% (C)			
		Score:	Max Score:	Min Score:	
* 1. Did agent greeted the Customer?	7	14.00	10.00	1.00	
* 2. Did agent was polite to Customer?	Yes	5.00	1.00	0.00	
* 3. How did the agent sound in speaking with the customer?	This agent loves hisher job	0.00	5.00	1.00	
* answer required					

8/23/2017 2:47 AM
Interaction Quality Manager Reports
Quality Scorecard
Page 1 of 1

You can also generate a report from the current scorecard. When the scorecard is displayed, click **Run Report**.

Questionnaire One - Call, recorded on 11/21/2012 4:42:37 PM

Passed
Failed
⚠ Scorecard is already finished.
Run Report
Calibration Only

Group 1 (Score: 0.00 % F)

Group 1

* 1. Question 1









4

Quality Scorecard Report Toolbar

The Quality Scorecard report includes a Report Viewer toolbar with features to assist you while viewing the report.

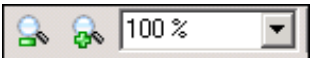
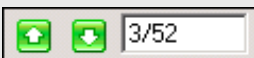
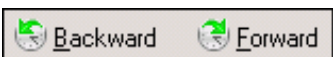

Here are the descriptions for the report toolbar buttons.

Toolbar Button	Description
	Display the Table of Contents
	Print the displayed report
	Copy the report to the Clipboard
	Use the Find button to search for text in a report
	Display a Single Page View of the report
	Display multiple pages of your report
	Scroll through your report one page at a time
	Zoom Out to see more of a report or Zoom In to get a close-up view of the report page. Type a percentage for the Zoom Value, or choose a setting from the drop-down list.
	View pages of your report with the Previous Page and Next Page buttons, or enter a specific page number in the Page Index field
	Move Backward and Forward through the history of viewed report pages
	Annotate your report by adding text and graphics
	Use Refresh to reload the report

Export Results Rows

Export the contents of search results into a CSV, Excel, or PDF file. Export **All** search results rows, or **Selected Rows**.

Follow these steps to export **All** rows from the search results grid:

1. Right-click on any search results row and on the shortcut menu point to **Export Results Rows**.
2. On the submenu, point to **All**.

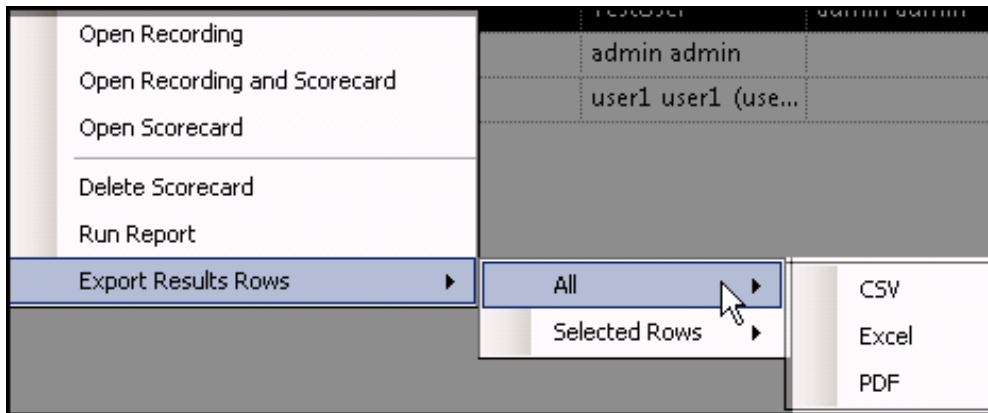

3. Select the file type for the exported file.
4. On the Save As dialog, select the folder to export the Results Rows to, and type a File name.

Follow these steps to export **Selected Rows** from the search results grid:

1. Select the search results rows to be exported.
2. Right-click on the selected rows, and on the shortcut menu point to **Export Results Rows**.
3. On the submenu, point to **Selected Rows**.

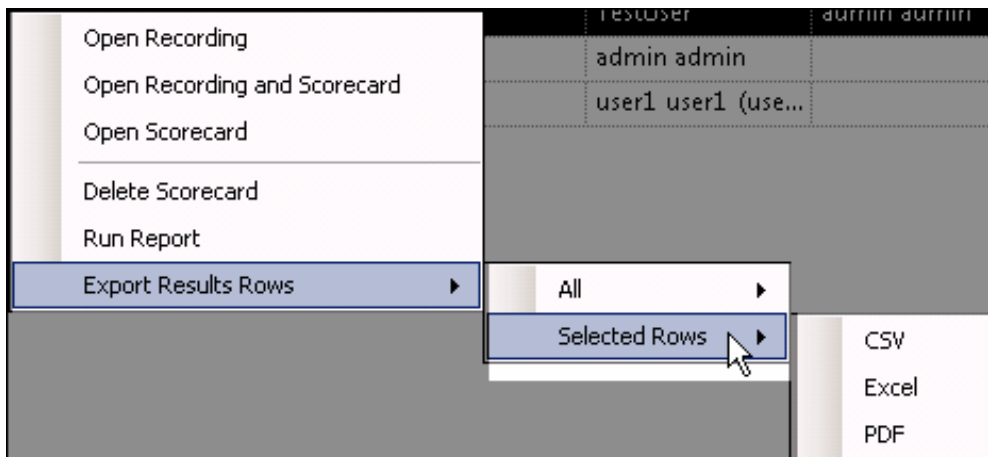

4. Select the file type for the exported file.
5. On the Save As dialog, select the folder to export the Selected Rows to, and type a File name.

Edit a Search

To edit an existing search, in **Searches** pane, right-click on a search and in the shortcut menu, click **Configure**. When you completed your changes, click **Save Search**.

You can also edit an existing search when the Search Results are displayed in the workspace by clicking the **Configure** button.

Important Note

If you migrated Interaction Recorder from 3.0 to 2015 R1 or later, issues might have occurred with Searches during the migration process. As a result, a **Migration Notes** control might be displayed in a Search Configuration view. For more information, see [Appendix B: Search Configuration Migration Notes Control](#).

Questionnaires

Questionnaires are used to score recorded interactions. Use Questionnaires to measure script adherence, compliance, and customer satisfaction. Questionnaires are integrated with scoring and simplify the quality assessment process, by easily adding a Questionnaire to the recording's Scoring page.

Use the Interaction Quality Manager workspace to create and publish Questionnaires.

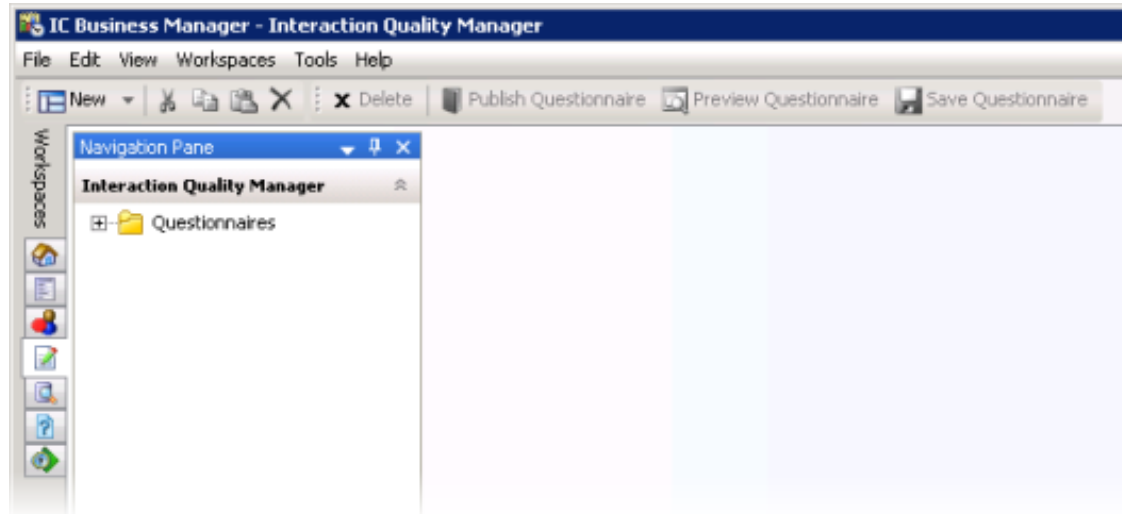

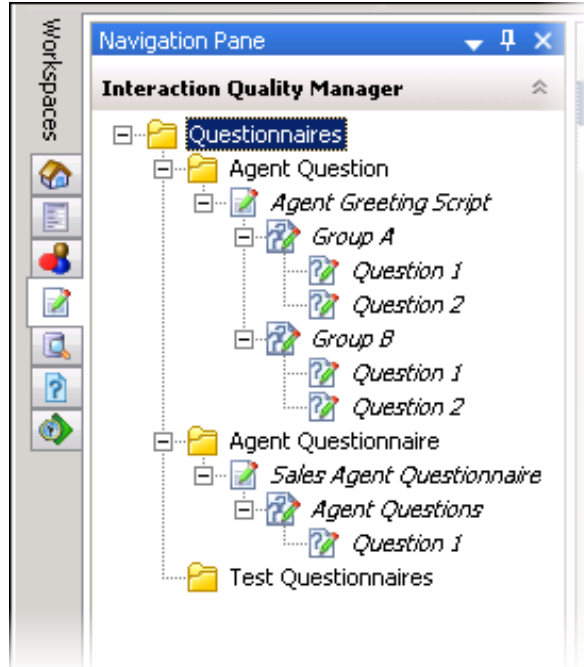

About the Interaction Quality Manager Navigation Pane

Use the Interaction Quality Manager pane to create and organize your Questionnaires. Questionnaires are created in folders, and Questions are organized within Groups.



- **Questionnaires Folder** Use the **Questionnaires** folder to create Questionnaire subfolders. To create a Questionnaire folder, select the **Questionnaires** folder, right-click, point to **New**, and click **Folder**. On the New Questionnaire Folder dialog, type a name for the folder.

When you select the **Questionnaires** folder, the Questionnaires List View—a list of all Questionnaires—is displayed in the workspace.

- **Questionnaire Folder** Use the Questionnaire folder to create new Questionnaires. To create a questionnaire in the folder, right-click, point to **New**, and click **Questionnaire**. A *New Questionnaire*  is created under the Questionnaire folder, and it includes a *Group*  and a *Question* .
- **Questionnaire** When a Questionnaire is created, it is displayed in the Questionnaire View in the workspace. Use the Questionnaire View to configure the settings for your questionnaire.

Descriptive Groups, which are created to organize Questions, can be added from the Questionnaire View. To create a Group from the Questionnaires pane, right-click on a Questionnaire, and click **New Group**.

Also, Questionnaires can be published from the Questionnaire View.

- **Group** When a Group is created, it is displayed in the Group View in the workspace. You configure Group settings in this view. Use a descriptive name for the Group, which will contain a set of logically related questions.

To create a question in a Group, right-click on a Group, and click **New Question**.

- **Question** When a Question is created, it is displayed in the Question View in the workspace. Configure the Question settings in the Question View. You can also add a new question from the Question View.

Note

For Security Access:

To create new Questionnaire folders, or delete existing Questionnaire Folders, a User must have the Application Security Right for Recorder Policy Create/Delete Questionnaire Directories and Modify Rankings assigned in Interaction Administrator on the Security page.

For a User to View or Modify Questionnaires, a User must have Access rights for the Recorder Questionnaires folders, assigned in Interaction Administrator on the Security page.

Creating a Questionnaire

Use the **Interaction Quality Manager** navigation pane to create Questionnaires for scoring recorded interactions. Questionnaires can be created to measure script adherence, compliance, and customer satisfaction. Questionnaires are integrated with scoring and simplify the quality assessment process, by easily adding a Questionnaire to a recording's Scoring page.

Note

For Security Access:

To create new Questionnaire folders, or delete existing Questionnaire Folders, a User must have the Application Security Rights for Recorder Policy Create/Delete Questionnaire Directories and Modify Rankings assigned in Interaction Administrator on the Security Page.

For a User to **View** or **Modify** Questionnaires, a User must have Access Rights for the **Recorder Questionnaires** folder, assigned in Interaction Administrator on the Security page.

Create a Questionnaire folder

When you create a questionnaire, first create a folder to hold your questionnaires. Here's how to create a folder to hold a Questionnaire:

1. In the **Interaction Quality Manager** pane, select the **Questionnaires** folder.
2. Right-click the Questionnaires folder, point to **New**, and click **Folder**. The New Questionnaire Folder dialog is displayed.
3. Type a descriptive name for the folder that will contain the questionnaire. In the **Description** box, you can type a description. This description is displayed in the tooltip for the folder.



When you have completed the dialog, click **OK**.

The new Questionnaire folder is created under **Questionnaires**.

Use the Questionnaire Directory view to add or change the description for a folder. To change the description, select the Questionnaire folder. The Questionnaire Directory view is displayed. Update the description in the **Description** box.

Create a Questionnaire

To create a questionnaire, right-click the questionnaire folder, point to **New**, and click **Questionnaire**. The new questionnaire is

displayed in the Questionnaire View in the workspace. A New Questionnaire  and a Group  and a Question  are automatically created in the Questionnaire folder.

Configure Questionnaire settings

Configure the settings for the *New Questionnaire*.

1. Select the  *New Questionnaire* in the Questionnaire folder. The current settings are displayed in the Questionnaire View in the workspace.
2. In the **Name** box type a descriptive name for your questionnaire. When you move to the next field, the Questionnaire name is updated in the Questionnaires pane.
3. You can make comments in the **Notes** box.
4. In the **Ranking** drop-down list, select a Ranking system. You can also create a new ranking system at this time by clicking **Create new ranking**.
5. To hide scores for incomplete questionnaires while they are being scored, select the **Hide scores when questionnaire scorecard is incomplete**. Choose this option so scorers cannot see the current ranking and scores for incomplete questionnaires while they are being scored. After the questionnaire scorecard is complete, the scores panel is displayed for the questionnaire.
6. If you want to hide the Pass/Fail buttons on the questionnaire scorecard, select the Hide Pass/Fail options on the questionnaire scorecard check box.

Minimum score and **Maximum score** for the Questionnaire are displayed.

Note

You can Add a new group to the questionnaire from this view by clicking **Add new group**.

Configure Questionnaire Group settings

When you have completed configuring the settings for the questionnaire, set the values for the  *Group*.

1. Select the **Group** in the Questionnaires pane under the questionnaire. The current settings are displayed in the Group View in the workspace.
2. In the **Name** box, type a descriptive name for the questionnaire Group. When you move to the next field, the group name is updated in the Questionnaire pane.
3. If you want to mark this group optional, allowing questions to be marked Not Applicable, select the **Allow group to be Optional** check box.

Minimum score and **Maximum score**, and **Total Score Contribution** for all Questions in the Group are displayed.

Note

You can Add a new question to the questionnaire from this view by clicking **Add new question**.

Configure Question settings

Next, to configure the settings for a question:

1. Select the  *Question* in the Group. The current settings are displayed in the Question View in the workspace.
2. In the **Question** box, type the name for the question. When you move to the next field, the question name is updated in the Questionnaire pane.
3. In the **Help Text** box, add any additional text that will help the scorer grade the question.
4. In the **Data type** drop-down list, select a question type. Depending on the question type you selected, other fields are presented for configuration. The available question types are: **Free text (non-scoring)**, **Integer**, **Multiple Choice**, **Numeric**, **True/False**, and **Yes/No**.
5. Assign a value to the question in the **Weight** box.
6. To allow comments to be added when scoring a Questionnaire, select the **Allow comments** check box.
7. To classify a Question, use the **Importance** drop-down box. Questions can be classified as:
 - **Required**, if the Question must be answered
 - **Optional**, if an answer is not required
 - **Critical**, when the question represents agent behavior that is a key requirement to successfully handling the interaction. Critical questions require a **Yes/No** or **True/False** answer type. Score value for Critical questions can be weighted and/or have a low value for a No or False response in order to result in a failing score. Additionally the scorer can choose to use the manual **Fail** button when the response to a Critical question is No or False.
8. To allow the Scorer to mark a Question not applicable, select the **Allow Not Applicable (N/A) Answer** check box. Selecting this box adds N/A to the list of choices for a response when Scoring a Questionnaire.

Minimum score and **Maximum score**, and **Total Score Contribution** for the Question are displayed.

Preview Questionnaire

You can preview a Questionnaire while you are creating it and after it has been published, using the **Preview Questionnaire**

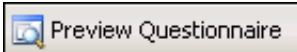

toolbar button . When the Questionnaire View or the Question View is displayed in the workspace, click Preview Questionnaire to display the Questionnaire Scorecard.

Save Questionnaire

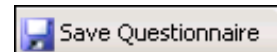

While you are creating a Questionnaire, you can save it using the **Save Questionnaire** toolbar button . Saving the Questionnaire allows you to edit and make changes to the questions before publishing. When your Questionnaire is saved, the name is no longer in italic.

Organize Groups and Questions

You can change the order of question groups in a questionnaire and you can also change the order of the questions within a group.

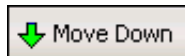

Use the **Move Down/ Move Up** toggle button on the toolbar to order groups and questions in your questionnaire.

Publishing a Questionnaire

Published questionnaires are activated and available for scoring. When a Questionnaire is published, it cannot be modified or unpublished. A published questionnaire can be deactivated if you do not want it available for scoring purposes. For more information, see [Deactivate or Activate a Questionnaire](#).

There are two ways to publish a questionnaire from the Questionnaire View:

- Clicking **Publish Questionnaire**



- Using the Publish Questionnaire toolbar button

Publish a Questionnaire

In the Questionnaires Navigation pane, unpublished Questionnaires are indicated by the unpublished questionnaire icon .

To publish a questionnaire:

1. From the Questionnaires Navigation pane, select the questionnaire to be published. The Questionnaire View is displayed in the workspace.
2. On the upper-right corner of the workspace, click **Publish Questionnaire**. Or, click the Publish Questionnaire button on the toolbar.

A message is displayed to remind you that when a Questionnaire is published, it cannot be modified or unpublished.

3. Click **OK**. The questionnaire is now displayed in the Questionnaire pane with a published questionnaire icon . Also, the group and question icons are updated to published icons.

Notes

Published Questionnaires can be duplicated and renamed, allowing you to create a new questionnaire with the same properties as the published questionnaire. The new, duplicated, questionnaire is unpublished and can be modified.

To delete a Published Questionnaire, the user needs to have write access to the questionnaire directory.

Deactivate or Activate a Questionnaire

Published Questionnaires are activated and available for scoring. If you do not want a questionnaire available for scoring purposes, a published questionnaire can be deactivated. Questionnaire and scorecard data are still available for historical reporting for deactivated questionnaires.

Following these steps to Deactivate a questionnaire.

1. In the Interaction Quality Manager navigation pane, right-click on the questionnaire to be deactivated. A shortcut menu is displayed.
2. On the shortcut menu, click Deactivate.

Deactivating a published questionnaire allows existing scorecard data, associated with the questionnaire, to be available for historical reporting purposes. Deactivated questionnaires are no longer available in IC Business Manager Interaction Recorder or for Interaction Recorder policies, for creating and assigning scorecards. If you want to add additional scorecards to a deactivated questionnaire, you can Activate the questionnaire again.

Follow these steps to Activate a questionnaire.

1. In the Interaction Quality Manager navigation pane, right-click on the questionnaire to be activated. A shortcut menu is displayed.
2. On the shortcut menu, click Activate.

To Deactivate and Activate Questionnaires, you must have Modify Access Control rights for Recorder Questionnaires, assigned in Interaction Administrator.

Tools Menu

Interaction Recorder and Interaction Quality Manager have a Tools menu on the menu bar. The Interaction Recorder Tools menu has the **Manage Interaction Recorder Settings** command. The Interaction Quality Manager Tools menu has the **Manage Questionnaire Rankings** command.

Manage Interaction Recorder Settings

Use Manage Interaction Recorder Settings to control the playback of Recorded Calls and to configure the Master Key Password.

To control the playback of Recorded Calls:

1. From the **Tools** menu, click **Manage Interaction Recorder Settings**. The Manage Interaction Recorder Settings dialog is displayed.



2. To have a recording playback immediately when the Detailed Results window is opened in the Search Results view, select the check box **Automatically begin playback of recorded calls**.
3. By default, Audio recordings are played back through your computer speakers. To playback recordings through your telephone handset, select the check box **Play recorded calls using the handset**.

To configure the Master Key Password:

Use the Master Key Password box to password protect the Master Key File and securely encrypt master key data. To create, change, or deactivate a Master Key Password, the user must be assigned the Security Right Master Key Password Administrator. To configure the Master Key Password, from the **Tools** menu, click **Manage Interaction Recorder Settings**. The Manage Interaction Recorder Settings dialog is displayed.

To create a new Master Key Password or to change the current password, click **Change password**.

When you create a new Master key password or change the password, the password is Activated, and the Deactivate password button is displayed. To deactivate the password, click **Deactive password**. To activate the password, click **Activate Password**, and on the Activate Password dialog, type the password and click Activate.

Important Note: PureConnect Customer Care cannot recover encrypted recordings if a Master Key Password is lost.

Manage Questionnaire Rankings

Questionnaire Rankings are scaled scores used to rate or grade Questionnaires. When a Questionnaire is completed, the final score is compared to the value defined in the Questionnaire's ranking.

Defining a Rank Group

Define ranking scales on the Questionnaires Rank Groups dialog.

To access the Questionnaires Rank Groups dialog, from the **Tools** menu click **Manage Questionnaire Rankings**. The Questionnaires Rank Groups dialog is displayed.

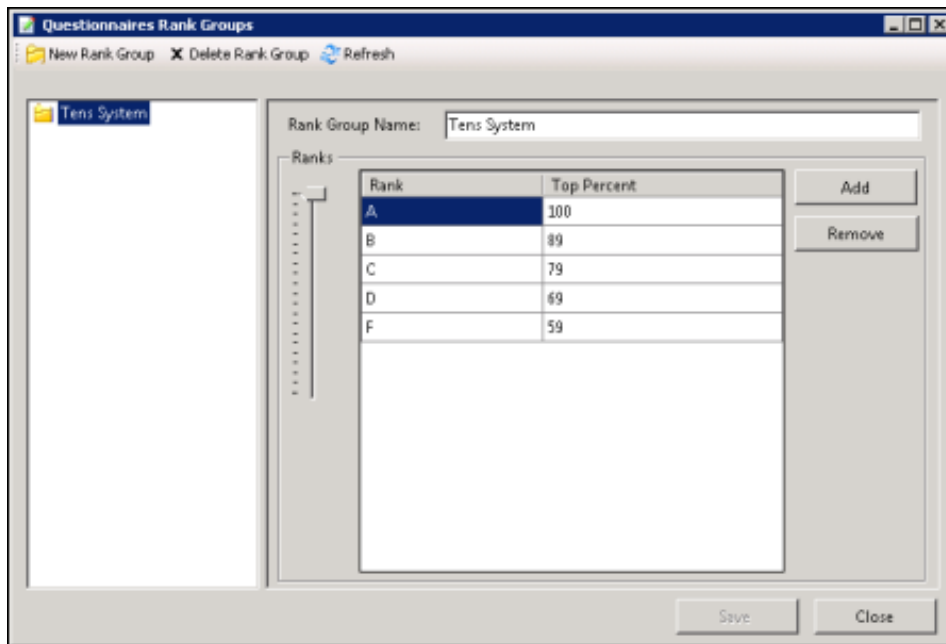

To define a new ranking scale for a Questionnaire, first create a new Rank Group.

1. On the toolbar click **New Group**. The **New Rank Group** is displayed under **Rank Groups** at the end of the list.
2. In the Rank Groups list, right-click **New Rank Group** and click **Rename** to name the new Rank Group.
3. Type the new name for this rank group, and press **Enter**. The new name is displayed in the **Group Name** box in the Rank Groups view. The Rank Group Name is limited to 40 characters.

Defining the ranking scale

To define the ranking scale for a Rank Group, select the Rank Group, and edit its properties in the right pane.

1. To add a **Rank**, click **Add**.
2. **New Rank** is added to the Rank list and is selected. Type a name for the ranking.
3. Use the **Ranks** percentage slider to select a percentage for the **Top Percent** column.

Define as many ranks as you choose to use in your ranking scale. Assign a top percent for each Rank in the **Top Percent** column, setting the highest percentage for the Rank in this column. For example, if A = 90-100 percent, the highest percentage, 100, is set in the Top Percent column. Therefore, if B = 80-89 percent, 89 is set in the Top Percent column for B. Next, C = 70-79 percent, and 79 is set in the Top Percent column for C. Rank D = 60-69 percent, and 69 is set in the Top Percent column for D. And the F Rank includes 0-59 percent when 59 is set as the Top Percent column for the Rank. The lowest Rank includes all scores below 59, including zero.

4. Click **Save**, and then click **Close** to exit the Questionnaires Rank Group dialog.

Assigning a Ranking to a Questionnaire

To assign a ranking to a Questionnaire, under **Questionnaires** select a Questionnaire to view it in the workspace.

Note

To assign or modify a ranking, a User must have the **Application** Security Rights for Recorder Policy **Create/Delete Questionnaire Directories and Modify Rankings** assigned in Interaction Administrator on the Security page.

In the **Ranking** drop-down list, select a Rank Group to assign to the Questionnaire.

Questionnaire is unpublished and currently not available [Publish Questionnaire](#)

Name: Agent Greeting Script

Notes:

Ranking: Tens System [Add new group...](#)

Tens System
Create new ranking... rd is incomplete

Hide Pass/Fail options on the questionnaire scorecard

Minimum score: 0.00
Maximum score: 0.00

Interaction Quality Manager View

Interaction Quality Manager view, in IC Business Manager, is used to retrieve recordings with associated Questionnaire Scorecards that need to be scored. The view also displays the scorecard status. Questionnaires can be automatically assigned to recordings by creating policies in Interaction Recorder Policy Editor.

Recordings with scorecards are retrieved based on:

- Date and Time
- Scorecard Status
- Scoring User

The Interaction Quality Manager intuitive user interface guides you to:

- Retrieve recordings to score
- Preview scorecards associated with recordings
- Playback and score recordings

Recordings to Score

To get started, from IC Business Manager, create a **New** view for an Interaction Quality Manager **Recordings to Score** view. To create this view, follow these steps.

1. From the IC Business Manager toolbar, click New. The Create New View dialog is displayed.

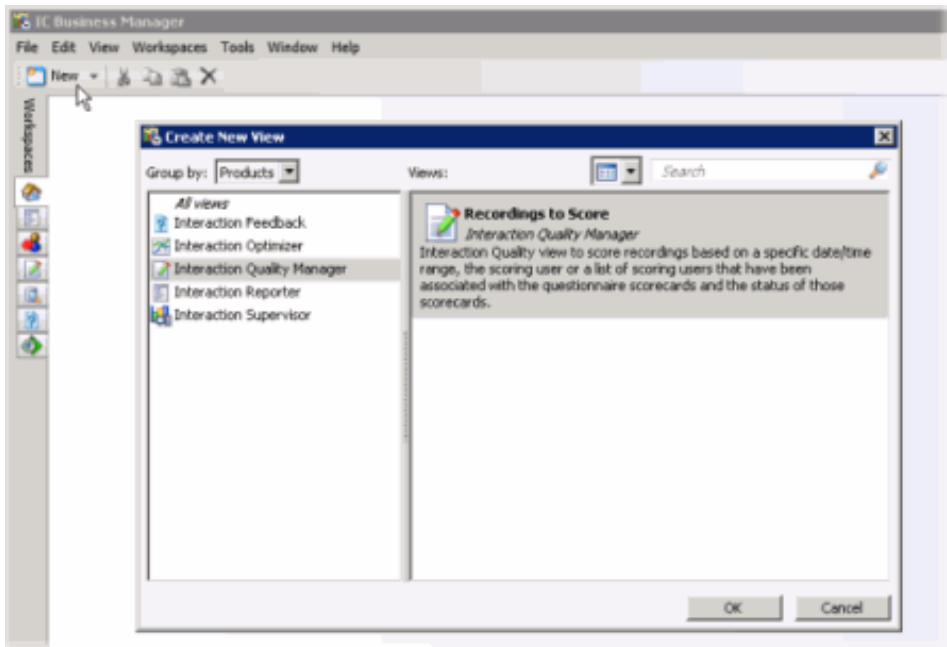

2. In the **Group by** box, select **Products** or select **Categories**. **Interaction Quality Manager** is displayed as an option in the left pane.
3. In the left pane, select **Interaction Quality Manager**. **Recordings to Score** view is displayed in the right pane of the Create New View dialog.
4. In the right pane, select **Recordings to Score** and click **OK**. The **Recordings to Score View Attributes** search dialog is displayed.

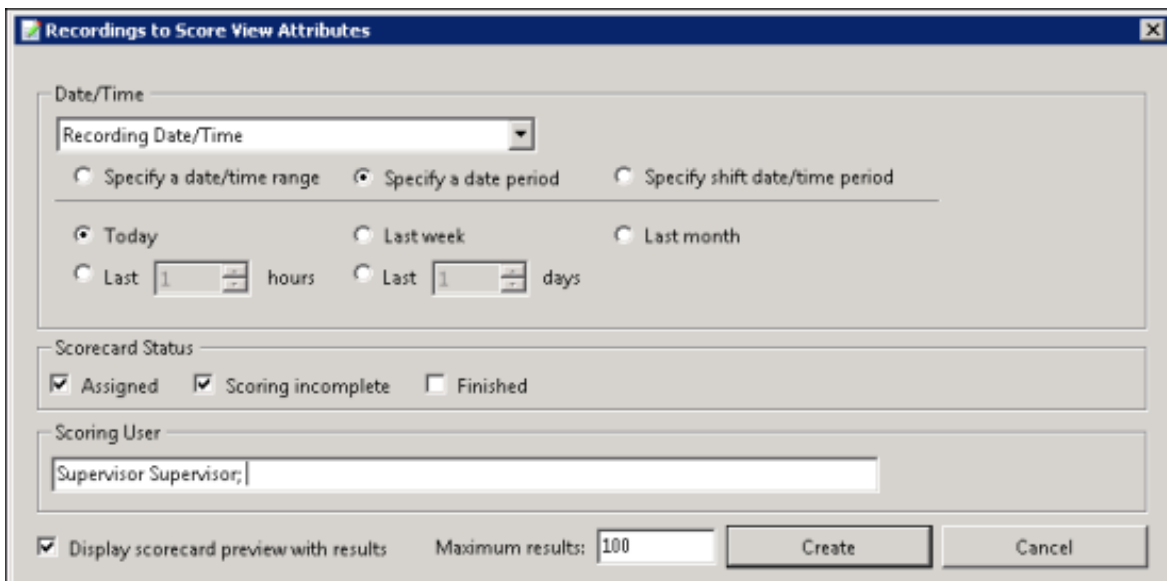

The available attributes are:

Date and Time

Select **Recording Date/Time** to retrieve recordings based on the date and time of the recording, or select **Scoring Date/Time** to retrieve recordings based on the date and time the recording was last scored, and configure the attribute.

Scorecard Status

The Scorecard Status attribute searches for recordings based on their scorecard status. To narrow your search, select a scorecard status check box. The available scorecard statuses are: **Assigned**, **Scoring incomplete**, and **Finished**.

You can select more than one status in a search. If no Scorecard Status check boxes are selected, recordings for all scoring statuses are included in the search results.

Scoring User

The Scoring User attribute searches for users who have scored recordings. In the Scoring User field, begin typing a user name to display available User Names to choose from. Multiple user names can be specified to create a list of scoring users.

Displaying Search Results

Use these settings for displaying your search results.

Display scorecard preview with results

Select the **Display scorecard preview with results** check box to show or hide the scorecard preview control when a recording is selected in the **Recordings to Score** view.

Maximum results

Specify the number of results to be returned with the search in the **Maximum results** box. Valid values are between 1 and 10000.

5. Complete the Recordings to Score View Attributes dialog, and click **Create**. The **Recordings to Score** view tab is displayed in the workspace.

The screenshot displays the 'Recordings to Score' application window. At the top, there is a table with columns: Scoring Date/Time, Scoring Status, Questionnaire Directory, Questionnaire, Recording Date/Time, Recording ID, and Scoring User. The first row is selected, showing a recording from 8/15/2013 11:55:14 AM with a score of 82.49%.

Scoring Date/Time	Scoring Status	Questionnaire Directory	Questionnaire	Recording Date/Time	Recording ID	Scoring User
8/15/2013 11:55:14 AM	Finished	Customer Service	Customer Service Abbreviated	8/15/2013 11:55:14 AM	6474212-986	Rob Sheppard
8/15/2013 2:49:23 PM	Finished	Customer Service	Customer Satisfaction Standard 1	8/15/2013 2:49:23 PM	51e11312-a7f...	Rebecca Gibson
8/15/2013 12:56:31 PM	Finished	Customer Service	Customer Service Abbreviated	8/15/2013 12:56:31 PM	4e445712-9a8d...	Ryan Logan
8/15/2013 9:59:18 PM	Finished	Sales/Marketing	RDMS	8/15/2013 9:59:18 PM	6e8f1113-9f8d...	Bradley Moore
8/15/2013 9:49:48 PM	Finished	Sales/Marketing	RDMS	8/15/2013 9:49:48 PM	6e8f1113-9f8d...	Bradley Moore
8/15/2013 9:49:14 PM	Finished	Sales/Marketing	RDMS	8/15/2013 9:49:14 PM	54e11312-738f...	Bradley Moore

Below the table, a call recording is previewed: 'Call recorded on 8/15/2013 11:55:14 AM', 'Duration: 00:01:07', 'Finished - Customer Service/ Customer Service Abbreviated', 'Scoring User: Rob Sheppard'. A scorecard is displayed with a 'Run Report' button and a 'Calibration Only' button. The scorecard is titled 'Greeting' and contains the following items:

- Greeting (Score: 71.78 % Good)
- Customer Service Skills (Score: 85.89 % Very Good)
- Hold Requests (Marked N/A)
- Communications / Pacing (Score: 55.56 % Unacceptable)
- Resolution Effort (Score: 100.00 % Perfect)

The scorecard preview shows a total score of 82.49% (Very Good) and includes a list of questions with radio button options for 'Yes' and 'No'.

Questions and options:

- *1. Used "Hi/Hi" or a similar salutation: Yes No
- *2. Identified self to Customer: Yes No
- *3. Did the agent act happy to get the call?
- *4. Comments re Agent greeting skills:
- Customer Service Skills
- Customer Service Skills
- *1. Did the agent possess good understanding of product line?

At the bottom left, the total score is displayed: 'Total Score: 82.49% Very Good'.

Search Attributes

The following table contains the Recordings to Score search attribute descriptions.

Attribute	Description
Date/Time	<p>Date/Time is a rich attribute that contains multiple sub-fields. First, in the Date/Time box: select Recording Date/Time to retrieve recordings based on the date and time of the recording; or select Scoring Date/Time to retrieve recordings based on the date and time the recording was last scored.</p> <p>You can select: Specify a date/time range, Specify a date period, or Specify shift date/time period. Operands are displayed depending on your selection.</p> <p>For Specify a date/time range, select an operator from the drop-down list. The available operators are: Equal, Before, After, or Between. Next, specify a date argument using the drop-down box and selecting a date from the calendar. Type or select a time to specify a time argument.</p> <p>For Specify a date period, specify a date in which the interactions occurred to be included in the search. Available options are: Today, Last week, Last month, Last N hours, or Last N days.</p> <p>For Specify shift date/time period, specify a shift date range and time of day range. For example, a shift date/time might be Monday through Friday, 8:00 a.m. to 5:00 p.m.</p> <p>The date/time attribute uses the Windows time zone set for the Windows User on the Interaction Recorder Client machine.</p>
Scorecard Status	<p>This attribute searches for recordings based on their scorecard status. The search options are Assigned, Scoring incomplete, or Finished.</p> <p>To narrow your search, select a scorecard status check box. You can select more than one status in a search. If no Scorecard Status check boxes are selected, recordings for all scoring statuses are included in the search results.</p>
Scoring User	<p>This attribute searches for users who have scored recordings.</p> <p>In the Scoring User field, begin typing a user name to display available User Names to choose from.</p> <p>Multiple user names can be specified to create a list of scoring users.</p>

Recordings to Score View

The Interaction Quality Manager Recordings to score view displays the results of the search in a grid and includes the details of a selected recording. The number of returned recordings to be scored from the search is indicated in the header of the view.

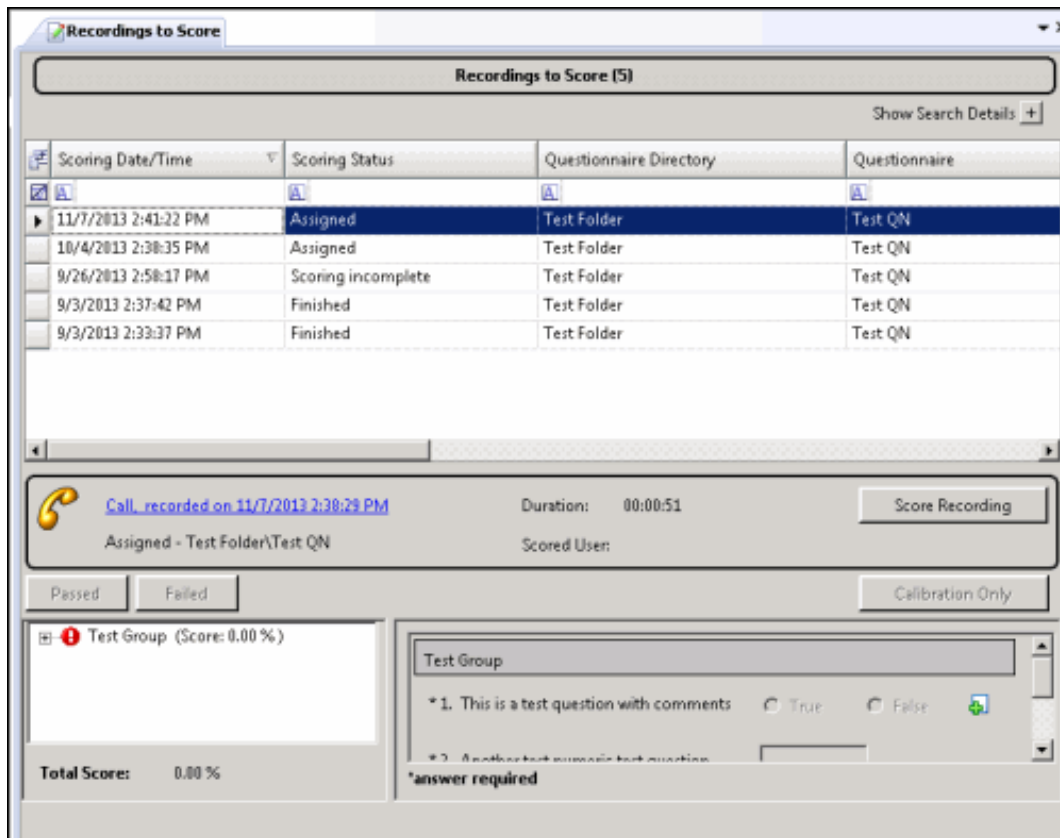

Show Search Details

Search attributes are collapsed when the view is displayed. To display the search attributes and run the search again, click the **Show Search Details** expand button.

To paste recording information into another application, use Ctrl+C in the grid to Copy an entire row, or multiple rows, to the clipboard.

Select Fields for the grid

The columns, or Fields, are displayed in the grid in the following order:

- Scoring Date/Time
- Scoring Status
- Questionnaire Directory
- Questionnaire
- Recording Date/Time
- Recording ID
- Scoring User
- Scored User
- Total Score
- Scorecard Rank
- Marked for Calibration
- Assign Questionnaire Policy





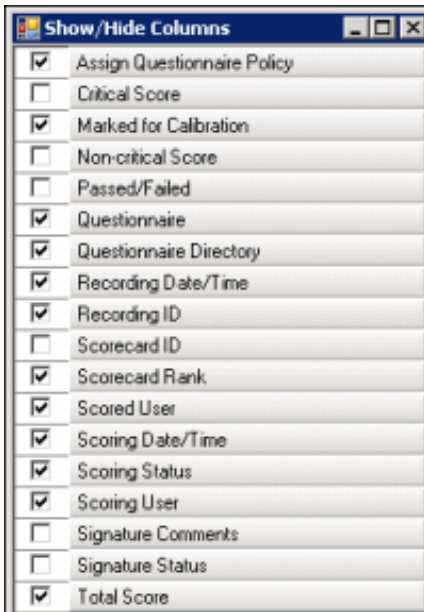

To change the Fields that are displayed in the grid, click the Field Chooser  on the upper left of the grid. In the Show/Hide Columns dialog select the fields to display in the grid.



Sorting Columns in the grid

To sort a grid column in ascending or descending order, click the Field name.

Refining search results

To further refine the search results, use the Filter Criteria selection fields  below each Field name. To create a field filter for the search results displayed in the grid, select the field below the Field name. To select an operand for the search, click , and then click the arrow to select the search criteria from the list. Depending on the field and your selections, an additional dialog might be displayed. The search results are displayed according to your search filter. To clear the search filter criteria, click clear filter criteria  for the field. To clear all filters, click clear all filter criteria  on the left of the filter fields grid row.

Recording Details

When you select a recording in the Search results list, detailed information about a recording and a scorecard preview is displayed below the grid.

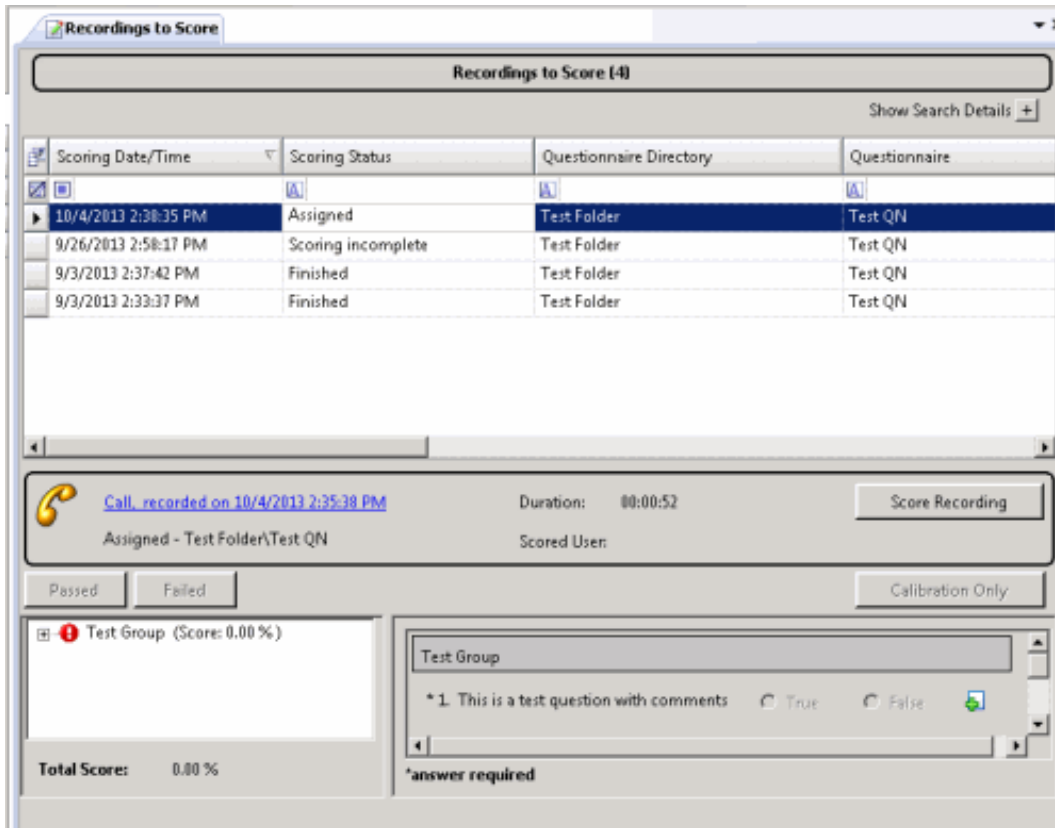

Score Recording

After you have selected a recording in the Search results list, if you have the **CanScoreRecording** security right assigned in Policy Editor associated with the recording, the Score Recording button is displayed.

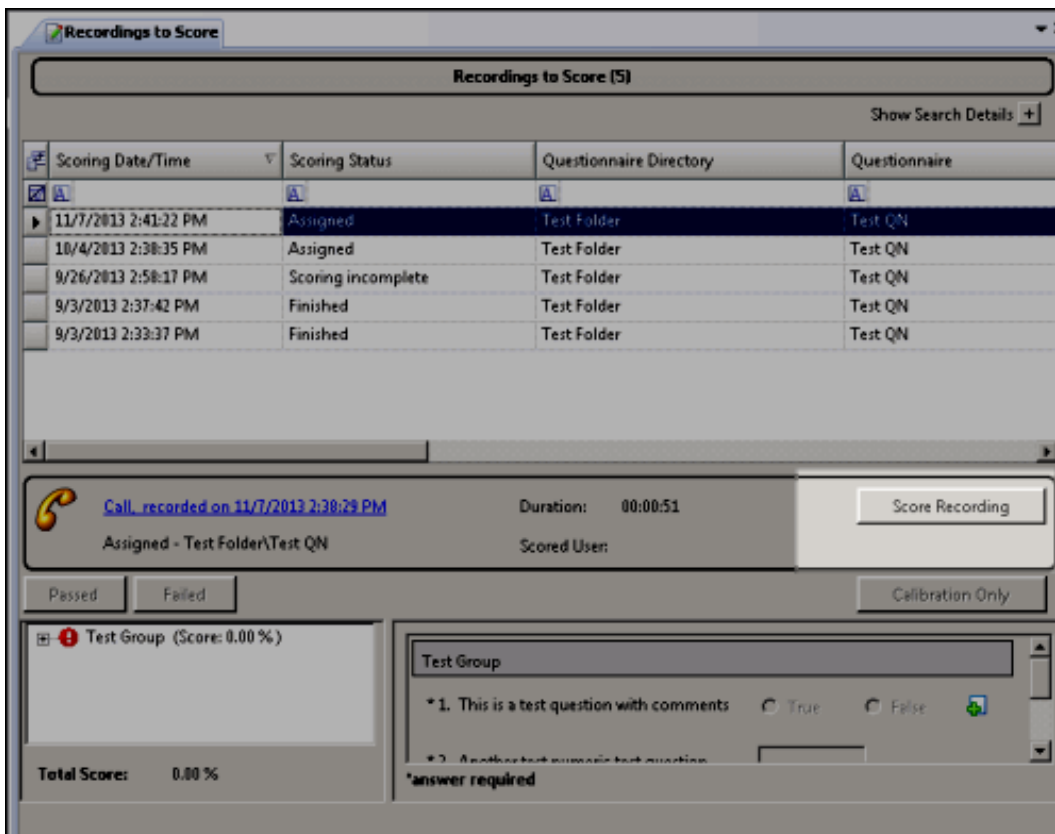

To score a recording, click **Score Recording**. The Scorecard assigned to the recording is displayed. The title of the Questionnaire is displayed in the dialog title bar.

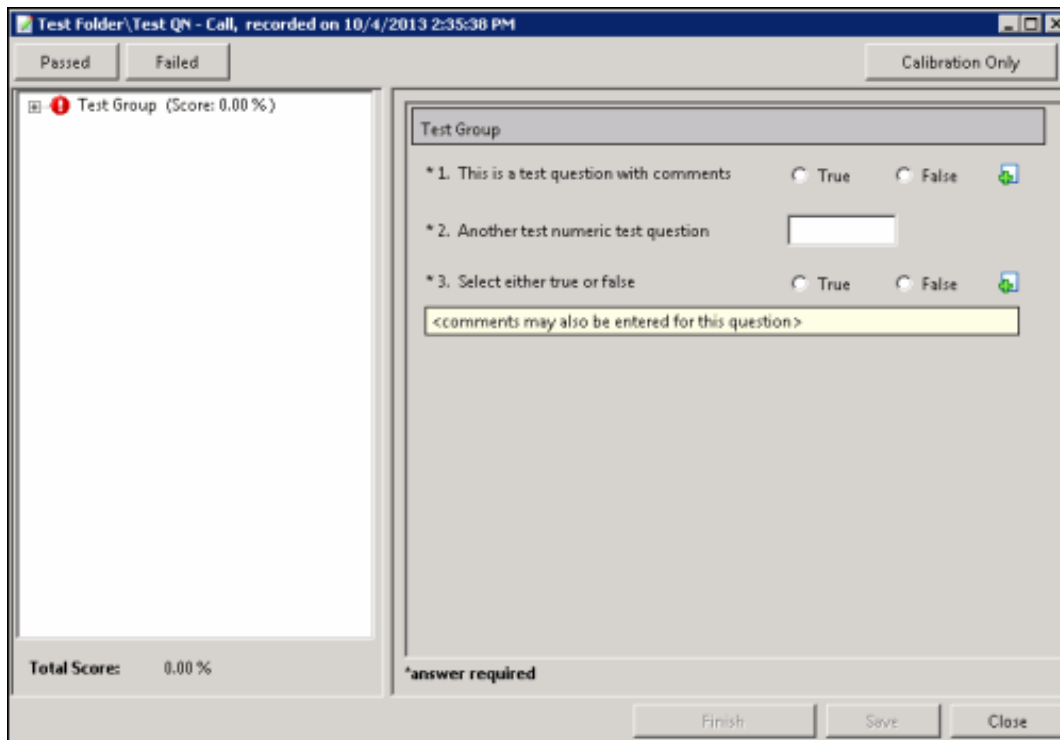

To score a recording:

1. Use the left pane to display Scorecard questions. Expand a Question Group. The questions are displayed in the right pane.
2. In the right pane, answer the questions.
 - Required questions are indicated by an asterisk (*).
 - If Help Text is available for a question, it is displayed below the question.
 - If a comment can be added to a question while scoring, it is indicated by the Add Comments  button.
 - As multiple Comment forms can be open at the same time, the title of the Comment form also displays the Question text, to help you identify which Comment form is associated with each question.
 - When Comment forms are displayed, you can continue scoring the recording.
 - If you press **Save** or **Finished** on the Scorecard when a Comment form is opened, a warning message is displayed prompting you to **Return to scoring** or **Continue saving**. Selecting **Return to scoring** terminates the Save operation and returns to the scoring process. Selecting **Continue saving** continues with the Save operation and closes and saves changes made in the open Comment forms.
3. Click **Passed** or **Failed**, and then click **Finish**.

Passed

Click this toggle button to indicate this Scorecard has passed.

Failed

Click this toggle button to indicate this Scorecard has failed. When the Failed button is selected a warning is displayed at the top of the dialog indicating the **Scorecard has been failed**, and the Finish button is labeled **Finish (Failed)**.

Calibration Only

Click this button to mark the Scorecard for calibration use only.

Note

Calibration provides confidence that monitored interactions will be scored consistently among Quality Assurance team members. Calibrating scoring ensures fairness to agents whose recorded interactions are being evaluated.

When a questionnaire is marked for Calibration, the score is excluded from other scored interactions and does not count toward the agent's performance results. Questionnaires marked for Calibration are also excluded from the overall group performance results.

Questionnaires marked for calibration are included in search results. To exclude questionnaires marked for calibration in search results, select No when configuring the Marked for Calibration search attribute.

When creating a Scorecard Search in IC Business Manager, you can search for Scorecards Marked for Calibration, to include them in your search results.

Calibration reports, in Interaction Reporter, are based on the results of completed evaluations marked for Calibration.

Scoring Results

The **Score** percentage and **Rank** are displayed by **Group** in the left pane next to the Question Group.

Total Score and Rank

The averaged percentage and rank for scored Question groups is displayed next to the **Total Score**.

Non-critical Score

If applicable for the Questionnaire, the averaged percentage for the Non-critical questions is displayed in **Non-critical Score**.

Critical Accuracy

If applicable for the Questionnaire, the averaged percentage for the critical questions is displayed in **Critical Accuracy**. The correct number of responses for the total number of critical questions is also indicated.

Save

To save a scored interaction to be emailed or to finish scoring later, click **Save**.

Finish

When you have completed scoring the interaction, click **Finish**. If the Scorecard has been failed, the Finish button is labeled **Finish (Failed)**. The scored results are now available for reporting.

Open a Recording

To open a recording associated with the Scorecard click the Recording title link.

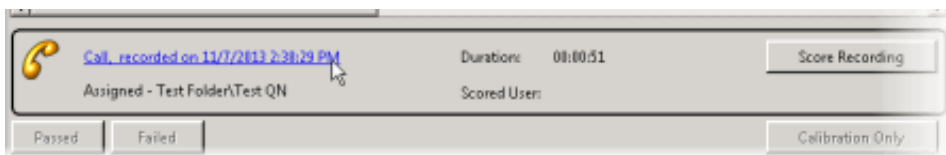

The recording opens for playback.

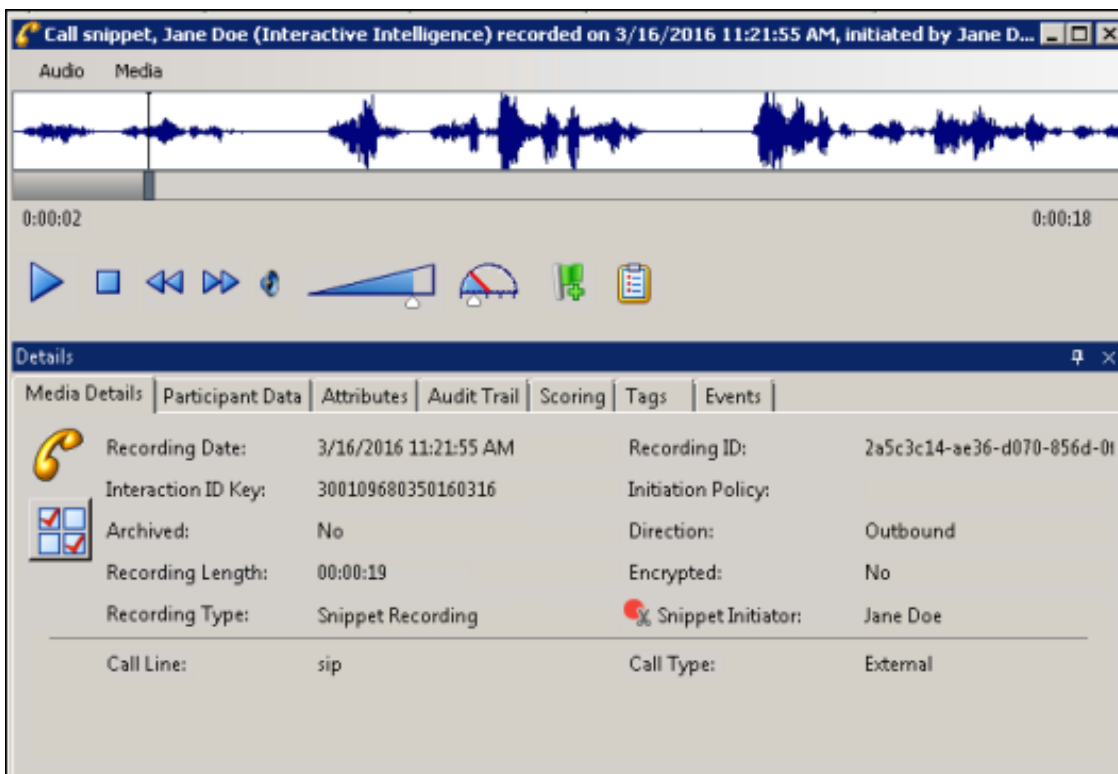

Recording Shortcut menu

Use the recording shortcut menu to open a recording and scorecard. To display the shortcut menu, right-click on a recording. You can also delete a scorecard from a recording from the shortcut menu.

Run Search

In addition to re-running a search from the Search Details, you can re-run a search with the Run Search toolbar button.

Interaction Recorder and Interaction Quality Manager Reports

Interaction Recorder and Interaction Quality Manager reporting is available in Interaction Reporter in IC Business Manager.

The available reports include:

- Calibration Details
- Calibration Question Group Details
- Calibration Recording Summary
- Quality Scoring Details
- Deleted Recording Audit by Date
- Deleted Recording Audit by User
- Recorder Questionnaire Detail
- Recorder Scoring Summary
- Recorder User Scoring Summary

For detailed information on configuring and running these reports, see the Interaction Reporter Help.

Note

You can also run a Quality Scorecard Report from Scorecard Search Results.

Appendix A: Recording Encryption

Recording Encryption securely stores and plays back recordings created with Interaction Recorder. This feature allows you to protect sensitive customer data, such as credit card information, and it meets the Payment Card Industry (PCI) standards for security. Interaction Recorder encrypts the following media files:

- Calls
- Chats
- Emails
- Screen recordings
- Social conversations

Interaction Recorder has a built-in Master Key file that allows Interaction Recorder to encrypt recordings when a Master Key file is not configured. The built-in Master Key file is not as secure as a custom generated Master Key file.

Recording Keys and Master Keys

Interaction Recorder uses strong encryption key cryptography to encrypt media files and recording keys. Recording keys are used to encrypt and decrypt recorded media files. For additional security, each recording key is encrypted by a Master Key.

Recording Keys

Recording keys are generated when the media file is created, and stored in the header of each media file. The recording key encrypts and decrypts the recorded media stored in the file.

Master Keys

A Master Key securely protects recording keys. Generating a new custom Master Key on a regular schedule helps to keep your information secure if a Master Key is lost or compromised.

Important note

If a Master Key file is lost, you will not be able to retrieve your recordings associated with that key. Master Keys are stored in the Master Key file and the Master Key file is encrypted using the Master Key Password.

Encryption Key security

To secure sensitive cardholder data, Interaction Recorder uses strong encryption key cryptography, the Advanced Encryption Standard (AES) encryption algorithm with a random 256-bit key, to encrypt both the media file and the Recording Key. Generated Recording Keys are used to encrypt and decrypt recorded media files, and are stored with each media file.

A Master Key securely protects recording keys. By default, the Master Keys are stored in the Master Key file in plain text. To secure the Master Keys, encrypt the Master Key File by creating a Master Key Password. Security of encrypted recordings is dependent on the administrator to safely secure the storage of the Master Key file and to restrict access to the file's location. If the contents of the Master Key file are lost, it is impossible to recover the recordings that are associated with those Master Keys.

Recording keys are encrypted with the most recent Master Key. If a Master Key is compromised, there is a security exposure to the recordings associated with that key. Therefore, it is recommended that Master Keys be automatically generated on a regular schedule. This procedure minimizes the potential loss by limiting the number of recordings associated with each Master Key.

After generating a new Master Key, enable Recording Encryption when you create your Initiation Policy in Interaction Recorder Policy Editor. For more information, see [Using Policy Editor](#).

Generating a Custom Master Key

Generate a new Master Key on the **Key Generation** page in the **Interaction Recorder configuration** dialog. To display this page:

1. From the Interaction Administrator tree view, select the **Interaction Recorder** container.

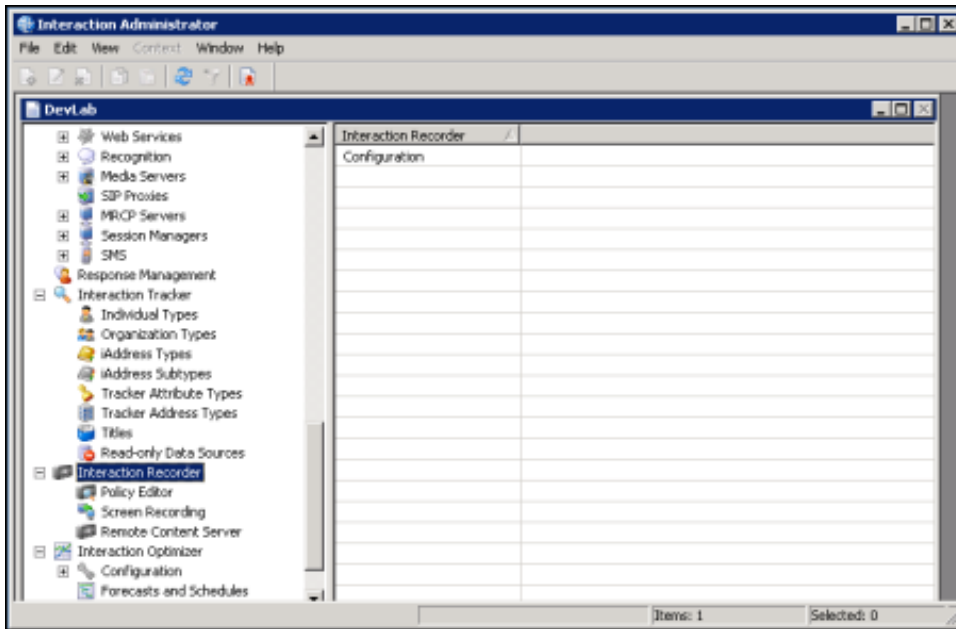

2. In the right pane, double-click **Configuration**. The Interaction Recorder Configuration dialog is displayed.

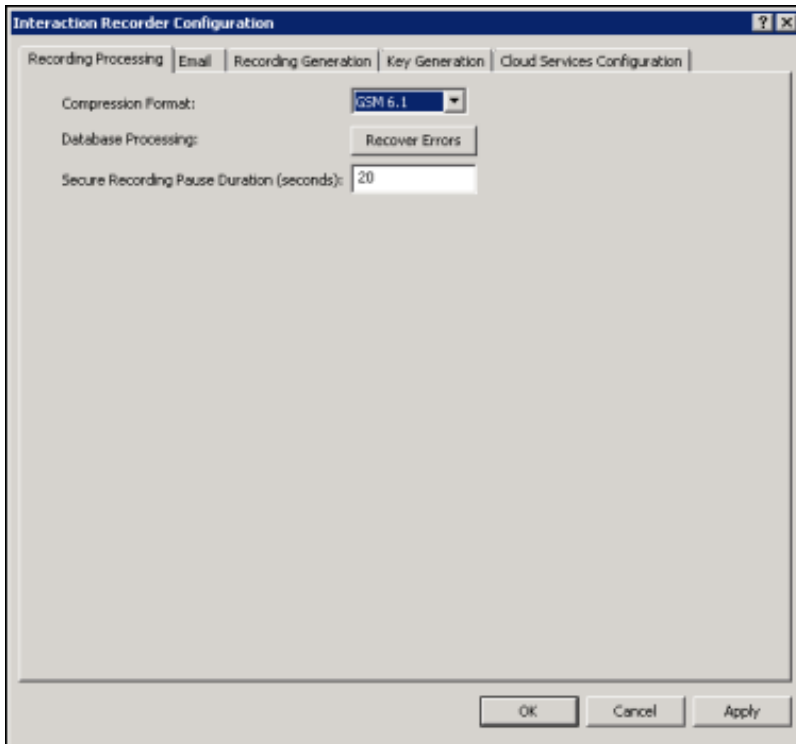

3. Click the **Key Generation** tab; the following page is displayed:

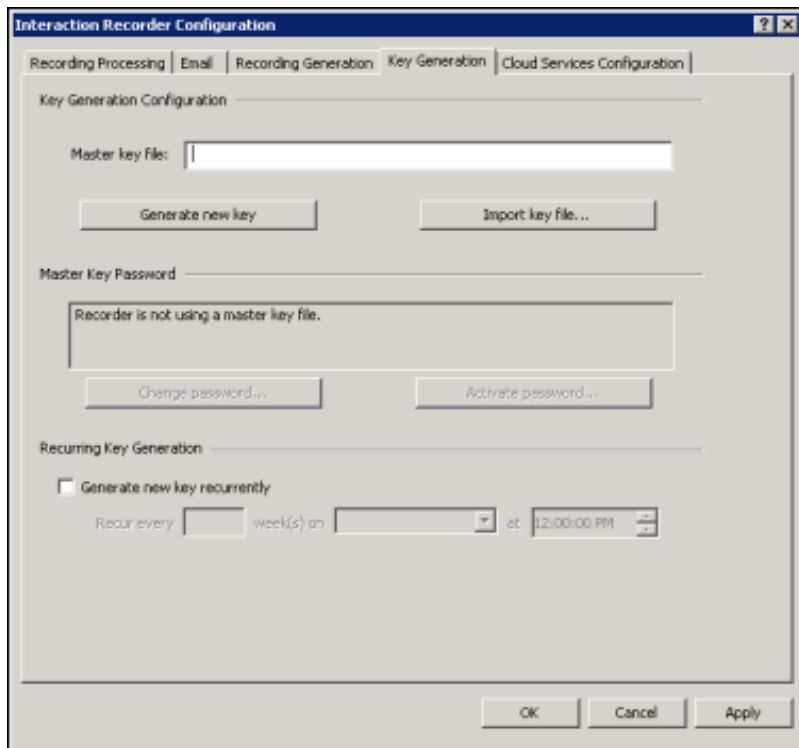

Use the Key Generation page to set up the Master Key file.

Setting up the Master Key File

The first step in generating a Master Key is to specify the location of the Master Key file. By default, the Master Keys are stored in the Master Key file in plain text. To secure the Master Keys, encrypt the Master Key File by creating a Master Key Password. For security purposes, make sure the location of the Master Key file has restricted access.

Key Generation Configuration

First, under **Key generation configuration** specify a location and file name for the file, in the **Master Key File** box. For security purposes, be sure the location of this file has restricted access.

The Master Key file must be accessible to the IC Server, which is where the IRServer process is running. Here are some examples of choosing a location for your key file:

Single IC server, local path:

Create a directory called `\I3\IC\Server\RecordingKey` (for example) and store your key file there. Set the directory to be accessible **ONLY** by the IC service account (YOURDOMAIN\icadmin as an example).

Switchover IC Pair, local path:

Create a directory called `\I3\IC\Server\RecordingKey` (for example) and store your key file there. Set the directory to be accessible **ONLY** by the IC service account (YOURDOMAIN\icadmin as an example). Set this directory to be mirrored by switchover by including it in the CustomMirrorDir server parameter. Verify it is being mirrored as well.

Switchover IC Pair, network path:

Create a directory on an external highly available file server and share it. Store your key file there. Make sure the share and the directory/file are set to be accessible **ONLY** by the IC service account (YOURDOMAIN\icadmin as an example).

You can manually generate a new Master Key or schedule a new key to be generated automatically on a weekly basis.

Manual Key Generation

To manually generate a new Master Key, click **Generate new key**. When you click **OK** or **Apply** for the first time, an initial Master Key is created and appended to the Master Key file. You can also use this button to manually create a new key and append it to the Master Key file.

Master Key Password

Use the Master Key Password box to password protect the Master Key File and securely encrypt master key data. To create, change, or deactivate a Master Key Password, the user must be assigned the Security Right **Master Key Password Administrator**.

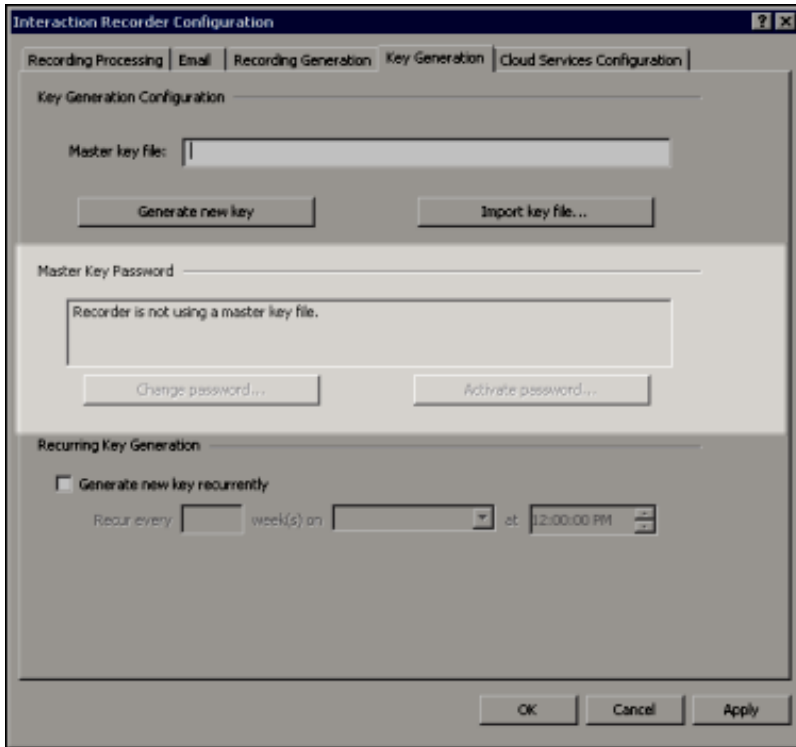

Important Note

PureConnect Customer Care cannot recover encrypted recordings if a Master Key Password is lost.

Change Password

Click **Change password** to create a new Master key password or to change the current password.

Deactivate/Activate Password

When you create a new Master key password or change the password, the password is Activated, and the **Deactivate password** button is displayed. To deactivate the password, click **Deactivate password**.

To activate the deactivated password, click **Activate Password**, and on the Activate Password dialog, type the current password and click **Activate**.

Recurring key generation

To automatically generate a new Master Key, under **Recurring Key Generation**, select the **Generate new key recurrently** check box. Enter the weekly recurrence, day, and time to schedule an automatic key generation. Click **OK**.

Backing up the Master Key file

When you generate a new Master Key, back up the Master Key file. Every time a new Master Key is generated it is appended to the Master Key file. It is critical that you back up your key file *every time* you generate a new Master Key. For example, if you configure recurring key generation every week on Friday at 5 p.m., a procedure should be scheduled to immediately back up the updated Master Key file.

Important note

If the Master Key file is ever lost, all encrypted recordings are effectively lost as they will no longer be able to be decrypted. Make sure your key file is backed up and make sure you practice the recovery method to know that it works. Ensure that the extra rights restrictions recommended for protecting this file don't interfere with your backup process.

The Master Key file is automatically backed up to the Certificates directory whenever a new Master Key or key file is generated. This back-up process makes it less likely that Master Keys will be lost due to deleting Master Key files, as a backup of every Master Key file will always be available.

Enabling Recording Encryption

Recording encryption is enabled when you create an Initiation Policy in Interaction Recorder Policy Editor. To enable recording encryption:

1. From the Interaction Administrator tree view, in the Interaction Recorder container, select **Policy Editor**.

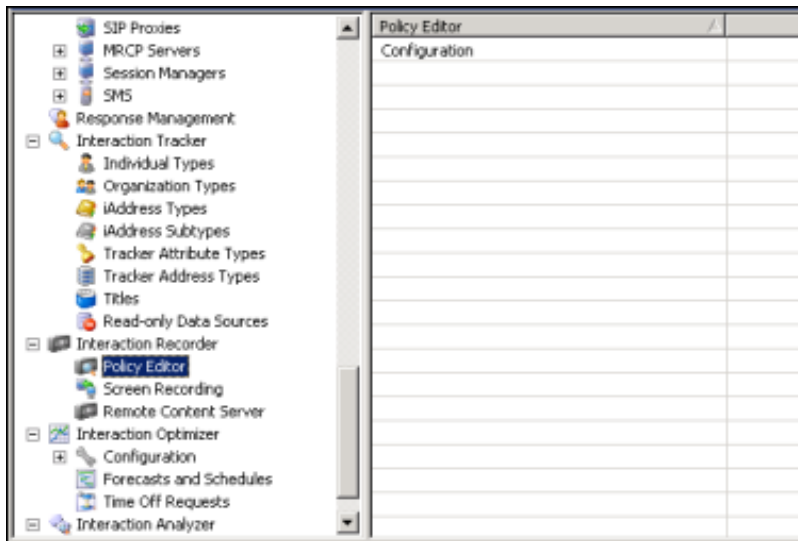

2. In the right pane, double-click **Configuration**. Interaction Recorder Policy Editor starts.

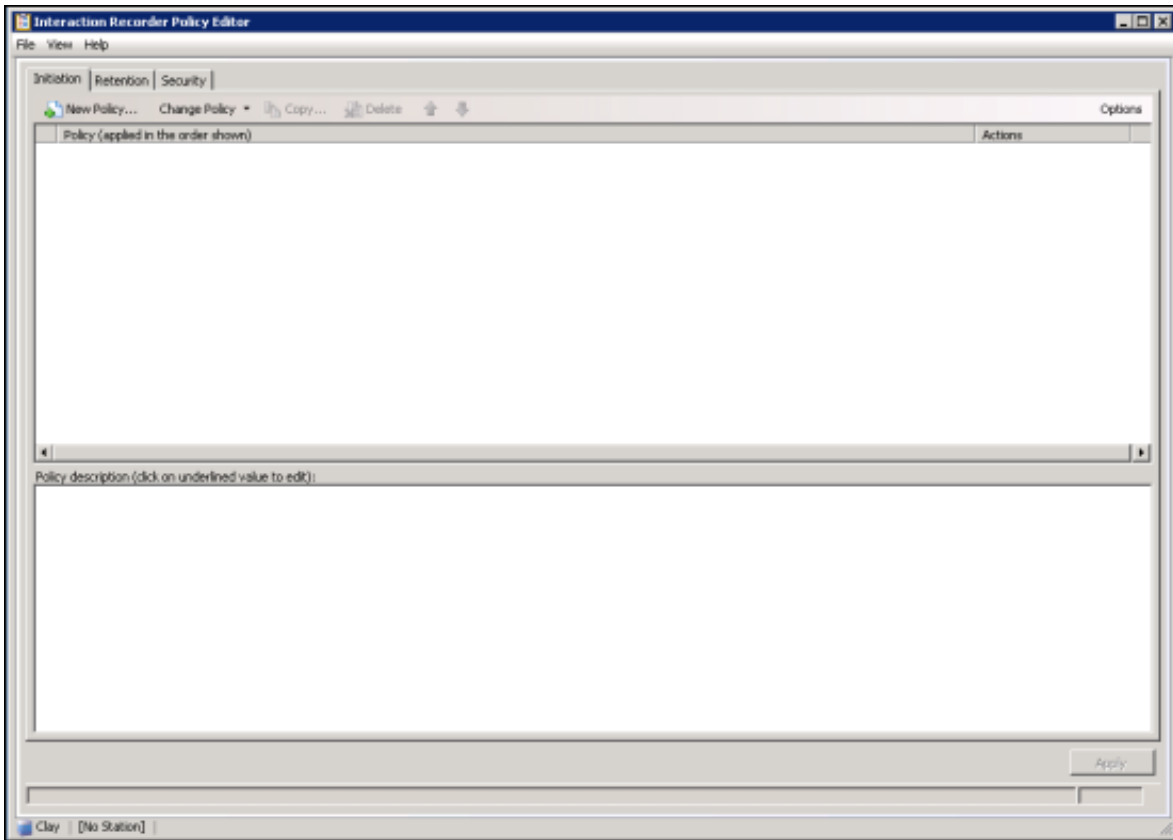

3. Encryption is enabled when creating an Initiation Policy, in Step 4: Select actions.

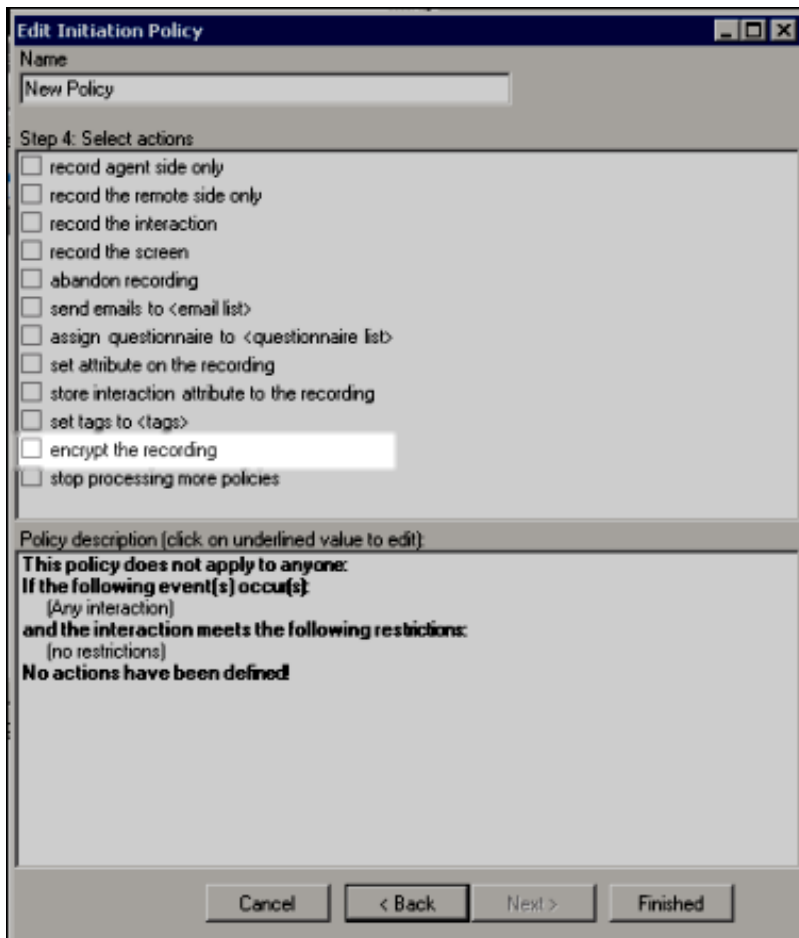

Note

When **Use Proactive Recording** is selected in Interaction Administrator Line Configuration, the **Encrypt Recordings** setting overrides the Interaction Recorder Policy Editor Initiation Policy action, **Encrypt the Recording**.

For example, if an Interaction Recorder Initiation Policy is *not* configured to **Encrypt the Recording** and the Interaction Administrator Line Configuration is set to **Use Proactive Recording** and **Encrypt Recordings** is selected, the line configuration setting overrides the Interaction Recorder Initiation Policy setting and the recording *is* encrypted.

Conversely, if an Interaction Recorder Initiation Policy *is* configured to **Encrypt the Recording** and the Interaction Administrator Line Configuration is set to **Use Proactive Recording** but **Encrypt Recordings** is *not* selected, the line configuration setting overrides the Interaction Recorder Initiation Policy setting and the recording is *not* encrypted.

A conflicting record call request logs a Configuration Error warning message in the Application log.

For more information on creating policies, see [Using Policy Editor](#).

Appendix B: Search Configuration Migration Notes Control

If issues occurred with Interaction Recorder Searches during the 3.0 to 2015 R1 or later Migration process, a Migration Notes control is displayed in a Search Configuration view, when running a search.

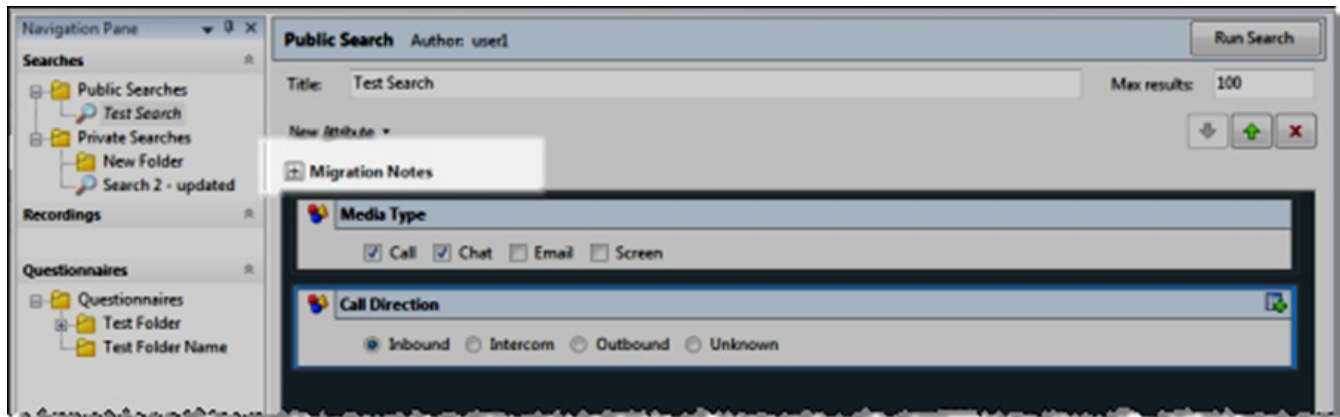

During the 3.0 to 2015 R1 or later Migration process, changes made to the search and attributes, contained within the search, are displayed when you expand the Migration Notes control.

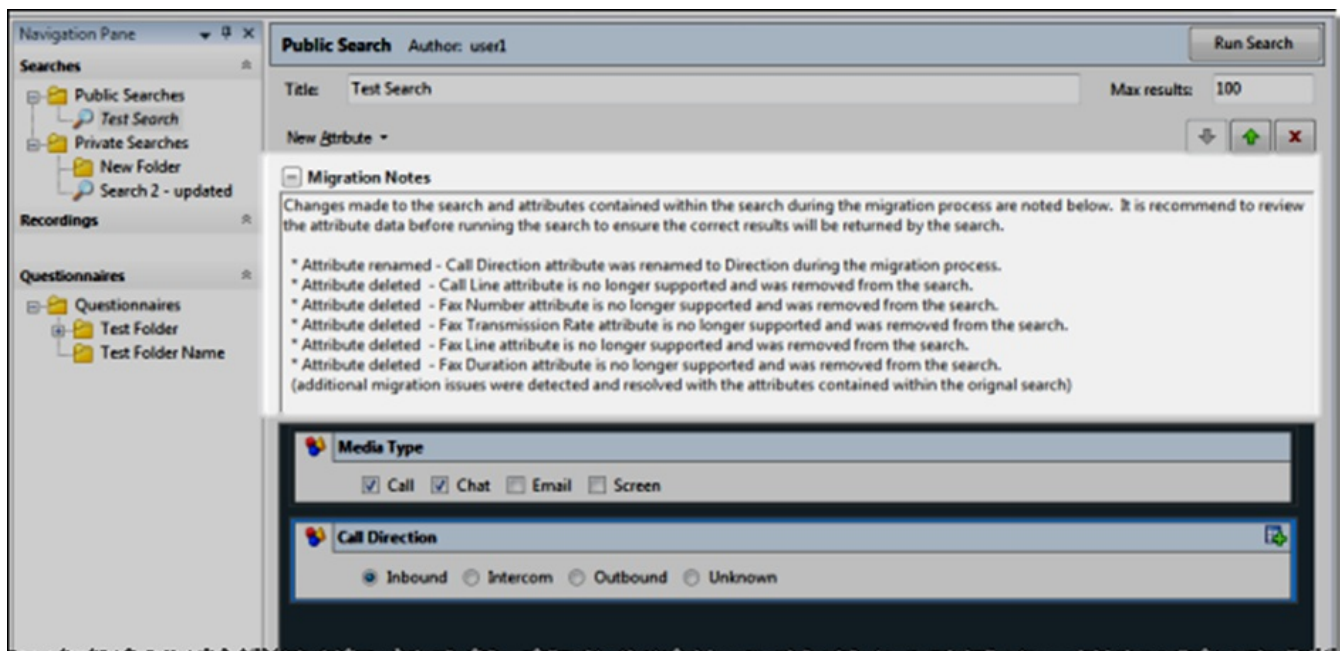

The Migration Notes control is displayed *only* if there were modifications to the search attributes during the migration process. For the correct results to be returned when running a search, we recommend you review your migrated searches *before* running a search.

Note

If *any* modifications are made to a search that is displaying the Migration Notes control, and the search is saved in 2015 R1 or later, the Migration Notes are discarded for that search and are no longer displayed.

Note on migrating recordings with a retention period

Recordings whose retention period is migrated are tagged with an 'IRRetentionMigrated' tag. You can search for this tag to identify recordings whose retention period has *or* has not been migrated.

Note on migrating recordings with a security policy

Recordings whose security is migrated are tagged with an 'IRSecurityMigrated' tag. You can search for this tag to identify recordings whose security has *or* has not been migrated.

For more information on the Migration process, see the [Interaction Migrator Technical Reference](#).

[Copyright and trademark](#)

Appendix C: Interaction Recorder Server Parameters

Server Parameter	Description
Recording Path	<p>This is a packaged Server Parameter, pre-configured, which specifies the directory on the IC Server used to store uncompressed manually recorded calls. The path is specified during the IC Server installation. Interaction Recorder uses its own setting to specify the Default Storage Location.</p> <p>If you used IC Setup Assistant during, CIC Sever installation, to configure the Interaction Recorder Compressed Files Location, the directory you specified is used to create the Default Storage Location Retention Policy.</p> <p>The Default Storage Location Retention Policy for compressed and processed recordings can be modified using Interaction Recorder Policy Editor.</p>
Disable Expired Recordings Processing	<p>Setting this parameter to True stops the Interaction Recorder Server from processing expired recordings.</p> <p>Note If you need to start processing expired recordings again, delete the server parameter <i>and</i> restart the Interaction Recorder Server. Alternatively, if you do not want to restart the Interaction Recorder Server, you can set the server parameter to False and Apply the change. The server parameter can then be deleted, if you choose.</p>
IR Search Unique Tracker Joins	<p>This optional server parameter controls how an Interaction Recorder search with multiple Participant Information attributes searches for participant information.</p> <p>When this server parameter is set to the value of 1, searches with multiple Participant Information attributes ANDed together will find recordings where one participant on the recording has one value and a different participant on the recording has another value.</p> <p>The default behavior, without this server parameter, searches that have multiple Participant Information attributes ANDed together will only find recordings where the same participant has all the specified values.</p> <p>Notes</p> <ul style="list-style-type: none"> • The additional flexibility offered by this server parameter comes with a significant time cost, and the additional expressiveness might not be worth the cost in query run time. • The behavior that this server parameter sets for Participant Information was the legacy behavior prior to 4.0 SU2. If you have searches that rely on multiple Participant Information attributes matching different participants for a recording, configure this server parameter to preserve that legacy behavior.

IR Use Recording Date For Expired Calculations

Setting this optional server parameter to **True** causes retention policies to be re-evaluated based on the recording date at the system level. And when this server parameter is set, you do not have to modify the Policy Editor Retention policy action, **re-evaluate retention policies in <time period>** for every Retention policy.

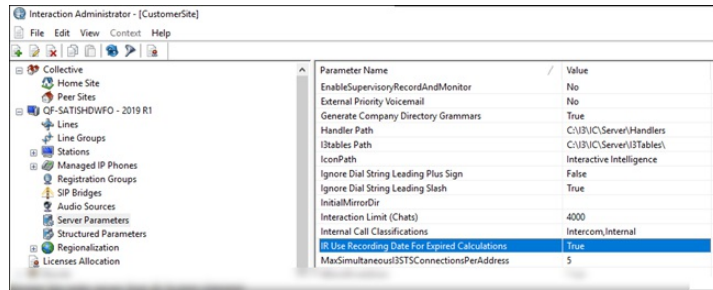

When this server parameter is set, the Policy Editor Retention policy configuration setting **Re-evaluate recordings based on the recording date** check box is not available, as the **IR Use Recording Date For Expired Calculations** server parameter is active.

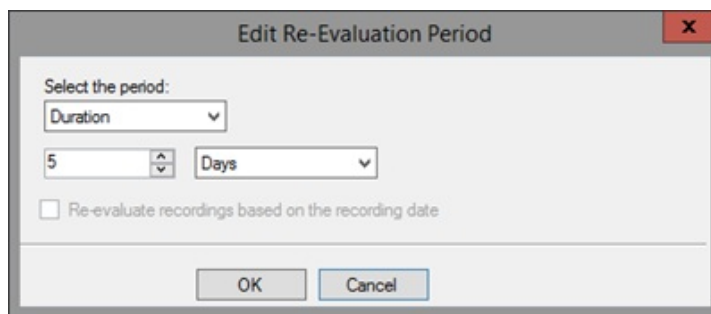

When this server parameter is set to False, or deleted, the check box is enabled again. And when the server parameter is turned off, the re-evaluation action will be based on the recording date only for those policies which had the check box selected by the user before turning on the server parameter.

Appendix D: Archive Recordings

Archive recordings to manage recorded interactions such as calls, chats, emails, and social media interactions. When you archive, the original recordings are copied in a playable format to an archive volume folder. The archive volume folder contains the archived recordings and an index that contains the archived recordings information in HTML format. Your existing recording information is maintained in the database and your recording data is kept in the file. Recordings are flagged in the database as being archived.

There are two ways to archive recordings: you can automatically archive recordings by creating an Interaction Recorder Policy Editor Retention Policy, and you can manually archive recordings from Interaction Recorder client in the search results grid.

For more information about archiving recordings, see the PureConnect Knowledge Base (KB) article, Archiving in Interaction Recorder, at: https://genesyspartner.force.com/customercare/pkb_Home?id=kA50B0000008R6j

Notes

To ensure that the path refers to the same location for all servers involved in the archiving operation, target your archiving to a non-local shared UNC path, in the form \\host\share\...

At each specific **Archive storage location**, the archiving file structure is based on the **Volume prefix**. Many independent archives can co-exist in the same **Archive storage location** as long as their Volume prefixes differ.

Automatically Archiving Recordings

You can automatically archive recordings using Interaction Recorder Policy Editor. Create a Retention Policy to automatically archive recordings. Before creating a Retention Policy, you'll need to determine where and when to store your archived recordings.

Note

As Retention Policies are evaluated on events only, it is important to ensure that your archiving Retention Policy is re-evaluated on time by setting the appropriate **re-evaluate** action in a previous Retention Policy.

Follow these steps to create a Retention Policy to archive a recording.

First, start Interaction Recorder Policy Editor:

1. From **Interaction Administrator** under **Interaction Recorder**, click **Policy Editor**. Policy Editor Configuration is displayed in the right pane.
2. In the **Policy Editor** pane, double-click **Configuration**. Interaction Recorder Policy Editor is displayed.
3. Click the **Retention** tab to display the page.
4. On the **Retention** page toolbar, click **New Policy**. The Edit Retention Policy dialog is displayed, beginning with **Step 1: Select Criteria**.
5. In the **Name** field, type a descriptive name for the Retention Policy to archive recordings.

Next, select the criteria for archiving your recordings.

1. Select the criteria for this Retention Policy to determine which recordings will be archived, for example:
 - To select recordings based on age, select **recording is <older/newer> than <duration> <period> old**.
 - To select recordings that have not been previously archived, select **recording has been archived: <true/false>**
2. In the **Policy description** pane, configure the criteria by clicking the variable. When you click a variable, a pop-up window is displayed to enter a value for the variable.
3. When you have completed configuring the retention criteria for archiving your recordings, click **Next**. The **Edit Retention Policy** dialog, **Step 2: Select actions** is displayed.

The next step is to configure the retention **Actions** for archiving your recordings.

1. In the **Step2: Select actions** box, select the **archive recordings to <location> for <volume_prefix> with chunks of <size>** check box. The policy is added to the **Policy description** pane.
2. In the **Policy description** pane, configure the variables for this action to archive recordings to a specific volume folder. Click the **media location** variable, and in the **Archive storage location** pop-up window, specify a valid non-local shared UNC path.
3. Click the **volume prefix** variable, and in the **Archive volume prefix** pop-up window, specify a prefix string for the archive volume name.
4. Click the **0 MB** variable, and in the **Edit Storage size** pop-up window, type the maximum storage size for each archive volume folder. Click the **MB** box to toggle between **MB** and **GB**.
Note When entering the storage size for an archive volume folder in an Archive action, the Edit Storage size dialog shows a red error rectangle around the storage size field and the OK button is not available, if the field is empty or 0 is specified. The Edit Storage Size dialog shows a yellow warning rectangle around the storage size field when the storage size is determined to be risky and outside of the normal storage range. A tooltip is displayed explaining the error or warning.
5. When you have completed configuring the settings for your Retention Policy to archive recordings, click **Finished**. The New Policy name is displayed and selected in the **Policy** pane.
6. Click **Apply** to save the Policy.

For additional information on creating Retention Policies, see "[Creating a Retention Policy](#)".

Manually Archiving Recordings

You can quickly archive recordings in Interaction Recorder client in IC Business Manager. To archive recordings in IC Business Manager, a user must have permission for the Security Policy **can export/archive recordings**.

Here are the steps to manually archive a recording in Interaction Recorder.

1. In Interaction Recorder, from the **Search Results** View, select one or more recordings to be archived.

- Right-click the recording, and on the shortcut menu click **Archive**.

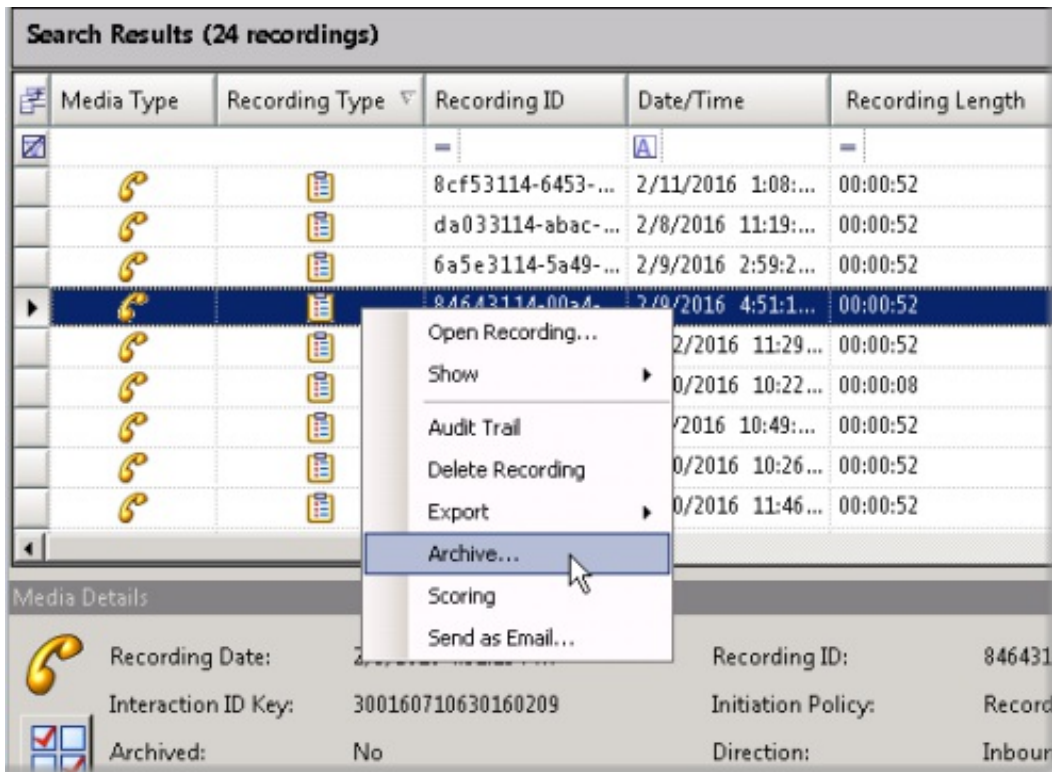

- On the **Archive Recording** dialog, select a location to archive the recording from a retention policy or enter an archive storage location.

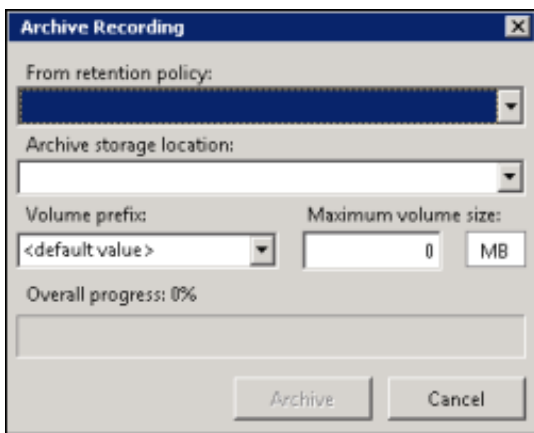

- **From retention policy**
When you select a retention policy, the fields **Archive storage location**, **Volume prefix**, and **Maximum volume size** are populated from the retention policy. These fields can be modified for your archive.
- **Archive storage location**
All storage locations from Archive Retention Policies are listed in the drop-down list. You can select a storage location from the list or type a valid non-local shared UNC path for the storage location. In the **Volume prefix** field, you can: accept the default value for a prefix, or select a prefix from the drop-down list, or type a new volume prefix. In the **Maximum volume size** field, type the maximum storage size for each archive volume folder, and then click the **MB** box to toggle between **MB** and **GB**.

Note When you select a **Social Media** recording to archive, the Social Media recording files are archived in a Zip format that contains the necessary files to view the recording. The playback website is also included in the Zip file.

- When you have configured the Archive Recording dialog, click **Archive**. The **Overall progress** indicator displays the percentage of the archive process that has been completed.

Working with Archived Content

Working with archived content is straightforward and easy, using HTML files to retrieve recordings.

The archive process creates two types of log files in the **Archive storage location**, the Archiving Volume content file and the Archiving Volume Content Index file. The Archiving Volume Content Index HTML file is named based on the **Volume prefix** for the retention policy. For example, if the volume prefix is PrV, the Archiving Volume Content Index file is named ArchVolContentIndex.PrV.html. Use the **Archiving Volume Content Index** to access recordings through the **Archiving Volume Content**.

Note

The Archive Process generates the Volume Content Index log file and the Volume Content log file, based on a set of resource templates. These resource templates produce HTML formatted output. The templates can be modified to produce custom logs, allowing you to save the metadata in a configurable format. For more information, see [Appendix E: Archive Log Resource Templates](#).

Retrieving Archived Recordings

To retrieve archived recordings, first view the Archiving Volume Content Index to display a list of Volume Content description files. Next open a Volume Content description file to display a list of archived recordings, and then select a recording to retrieve.

Viewing the Archiving Volume Content Index

Follow these steps to view the Volume Content list of files in the Archiving Volume Content Index.

1. Navigate to the Archive storage location.

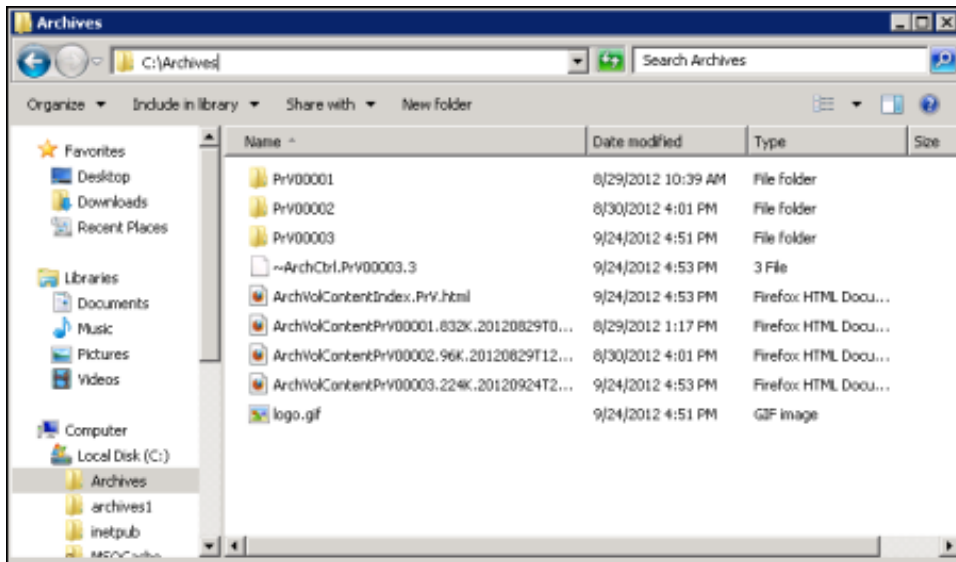

2. Double-click the Archiving Volume Content Index file.

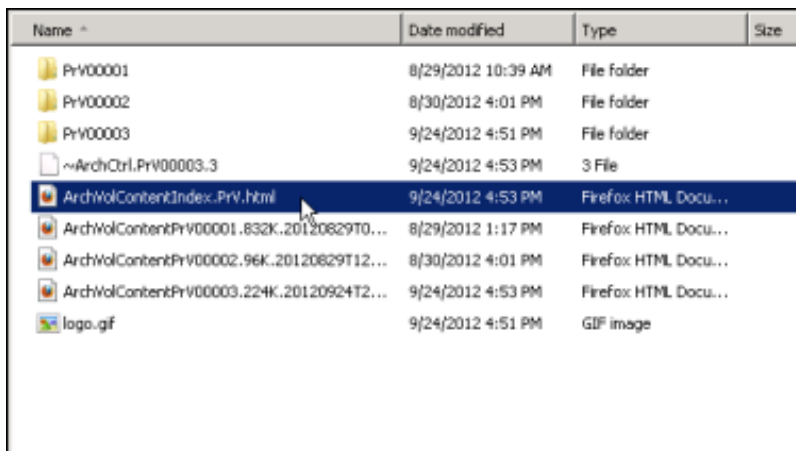

The Archiving Volume Content Index is displayed.



The Archiving Volume Content Index lists all the Volume Content description files that are in the same path and have the same Volume Prefix as the Volume Content Index. Each entry contains the Volume Content file name and the size of the Volume's folder. The Volume Content file name is a hyperlink to the Volume Content file.

Displaying a List of Archived Recordings

Display a list of archived recordings in an Archiving Volume Content description file, in order to retrieve a recording. To do this, in the **Volume Content** column, click a file name.

The content of the Archive Volume is displayed.

 Archiving Volume Content:

Recording ID	Media Type	Recording Type	File Path	Recording Date	File Size (bytes)	Direction	First participant	Other participants	To Connection	From Connection	Tag	Attributes
0899Ab14-a90-807f-81e6-1046a3e0900	Call	Policy-based	Vo8090812617681759148.DRCa8_0899Ab14-a90-807f-81e6-1046a3e0900.wav	2017-08-17 05:46:03	51816	Intercom	genesysa_user genesysa_user	user1 user1	10001	10000		
2199Ab14-46e-80c4-81e6-1046a3e0900	Call	Policy-based	Vo8090812617681759148.DRCa8_2199Ab14-46e-80c4-81e6-1046a3e0900.wav	2017-08-17 05:48:08	52290	Intercom	genesysa_user genesysa_user	user1 user1	10001	10000		
2099Ab14-754b-807f-81e6-1046a3e0900	Call	Policy-based	Vo8090812617681759148.DRCa8_2099Ab14-754b-807f-81e6-1046a3e0900.wav	2017-08-17 05:48:31	42310	Intercom	genesysa_user genesysa_user	user1 user1	10001	10000		

This volume content was automatically generated by Recorder Archiving.

© Genesys

The Volume Content file contains the list of archived recordings, and each entry can contain information for the following attributes.

- Recording ID
- Media Type
- Recording Type
- File Path
- Recording Date
- File Size in bytes
- Direction of the call
- First Participant
- Other Participants
- Tags associated with the recording
- Custom Attributes and values associated with the recording

Each entry contains a hyperlinked file path to retrieve the recording.

Retrieving a recording

To retrieve a recording, in the **Archiving Volume Content** list, in the **File Path** column, click the file path hyperlink for a recording. The recording is retrieved, and depending on the media type, the recording is played or displayed.

Note

There is no facility to playback a screen recording from the archived volume.

For example, a Call recording is played.

File Path	Recording Date
PrV00001/2012/08/29/09/50/IRCall_10d6ae12-272a-d03e-873a-64d55be70001.wav	2012/08/29 09:58:23
PrV00001/2012/08/29/09/50/IRCall_10d6ae12-272a-d03e-873a-64d55be70001.wav	2/08/29 09:58:23
PrV00001/2012/08/29/09/50/IRCall_10d6ae12-272a-d03e-873a-64d55be70001.wav	2/08/29 09:58:27
PrV00001/2012/08/29/09/50/IRCall_10d6ae12-272a-d03e-873a-64d55be70001.wav	2/08/29 09:58:44
PrV00001/2012/08/29/09/50/IRCall_10d6ae12-272a-d03e-873a-64d55be70001.wav	2/08/29 09:58:44
PrV00001/2012/08/29/12/30/IREmail_dddeae12-f595-d02f-...	2/08/29 12:39:24
PrV00001/2012/08/29/12/30/IREmail_dddeae12-f595-d02f-...	2012/08/29

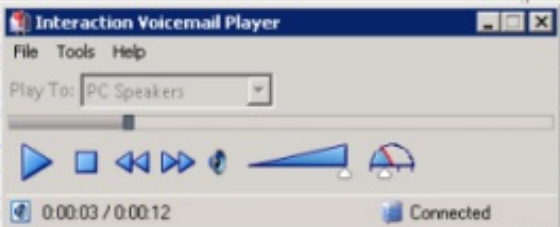

Or, an Email recording is displayed.

##I3_SUBJECT_TEXT##Policy match notification: recording id: ##I3_SUBJECT_TEXT## ##I3_NORECID_TEXT##No recording produced##I3_NORECID_TEXT##

GENESYS

A policy match has occurred for the following recording:

Recording id: ##I3_RECID##
Policy name: ##I3_POLICYNAME##
Policy type: ##I3_POLICYTYPE##
Date: ##I3_DATE##
Time: ##I3_TIME##

This email was automatically generated by Recorder Policy Manager. Notification settings can be adjusted using the Recorder Policy Editor.

[Interaction id: ##I3_INTXID##]

© Genesys

Appendix E: Archive Log Resource Templates

The Archive Process generates the Volume Content Index log file and the Volume Content log file, based on a set of resource templates. These resource templates produce HTML formatted output. The templates can be modified to produce custom logs, allowing you to save the metadata in a configurable format. For example, you can quickly produce text logs or CSV files that can be loaded into a database.

The following section describes how to modify the resource templates and produce custom archive logs.

Modifying Resource Templates

Follow these guidelines to modify the resource templates for the Volume Content Index log file and the Volume Content log file.

Note

Before modifying resource templates, we strongly recommend making a backup copy of the resource templates `recorder-archive-vol-content-index.xx-XX.dat` and `recorder-archive-vol-content.xx-XX.dat`, where `xx-XX` represents the language code for your system. For example, `en-US` is the language code for US English. The resource template files are located in the `I3\IC\Resources` directory.

Template Guidelines

Here are the guidelines for modifying the Volume Content Index log file and the Volume Content log file templates.

- The template file names are `recorder-archive-vol-content-index.xx-XX.dat` and `recorder-archive-vol-content.xx-XX.dat`, where `xx-XX` represents the language code for your system.
- The templates are read from the `I3\IC\Resources` directory and cached in memory every few minutes.
- Each template file must contain a file name surrounded by the delimiter `##FILE_NAME##`.
- The file name is the name and extension of the log file generated by the template.
- Note that the file name and its delimiters are removed from the data when the report is generated.

Volume Content Index log file

Use the template guidelines to customize your archive logs. The following is an example of the **Volume Content Index resource template**.

```

<!DOCTYPE HTML PUBLIC "-//W3C//DTD HTML 4.01 Transitional//EN"
"http://www.w3.org/TR/html4/loose.dtd">
<html>

<head>
<META http-equiv="Content-Type" content="text/html; charset=utf-8">
<title>Archive volume Content Index</title>

<style type="text/css">
.footer {
    font-family: verdana, 'Lucida Grande', arial, sans-serif;
    font-size: 10px;
    color: #333333;
    line-height: 1.3;
    text-decoration: none;
    margin-bottom: 10px;
}
th { text-align: left; font-weight: bold}
</style>
</head>
##FILE_NAME##ArchVolContentIndex.html##FILE_NAME##
##XFER_FILE##logo.gif##XFER_FILE##
<body>

<p>

</p>

<p>
Archiving volume Content Index:
</p>

<p>
<table border=1>
<tr>
<th>##</th>
<th>Volume Content</th>
<th>volume Size (K)</th>
</tr>
##FILE_LIST####FIRST_START_HERE##
<tr>
<td>##SEQUENCE_NUMBER##</td>
<td><a href=##VOLUME_CONTENT_NAME##>##VOLUME_CONTENT_NAME##</td>
<td>##VOLUME_SIZE##</td>
</tr>
##FILE_LIST##
</table>
</p>

<p>This index was automatically generated by Recorder Archiving.</p>

<p><span style='font-size:9.0pt;font-family:"Calibri","sans-serif";"Times New
Roman";color:#1F497D'>
<br>
</span></p>

<br><br>

<div align="center" class="footer">
&copy; Genesys
</div>

</body>
</html>

```

In the previous example, the following delimiters and placeholders are used:

Delimiter or Placeholder	Description
##FILE_NAME##	Required delimiter. Used to get the resulting filename.
##XFER_FILE##	Optional delimiter. Used to get the name of the accompanying files. The files can be icons or other files. These files will be copied to the same path as the resulting file.
##FILE_LIST##	Required delimiter. Used to present the list of Volume Content file descriptions. Between these delimiters, the data will be reused to generate each Volume Content description.
##FIRST_START_HERE##	Optional placeholder. Used to indicate the start of the first line in the resulting list. For example, if you have: ##FILE_LIST## ##FIRST_START_HERE## ##SEQUENCE_NUMBER## ##FILE_LIST## you will get the following output for a list of five elements: 1 2 3 4 5
##SEQUENCE_NUMBER##	Optional placeholder. Placeholder will be replaced by a consecutive number incrementing at each row.
##VOLUME_CONTENT_NAME##	Optional placeholder. Placeholder will be replaced by the file name of each Volume Content. Note that it has been used twice for the hyperlink.
##VOLUME_SIZE##	Optional placeholder. Placeholder will be replaced by each Volume Size.

As shown in the earlier example of the Volume Content Index resource template, you can produce an HTML file. You can also produce most other types of files or simply text files.

Additional delimiters and placeholders are available to improve the Volume Content Index or to allow the editing of a particular file format. The following is a list of the additional delimiters and placeholders and their descriptions.

Delimiter or Placeholder	Description
##DISABLE_INDEX_LOG##	Optional delimiter. Used to disable or enable Volume Content Index logging. A delimited value different to '0' will disable the index logging.
##DEFAULT_VOLUME_PREFIX##	Optional delimiter. Used to set the default volume prefix. This is the default when no specific volume prefix is requested. If this parameter is not present, "Vol" will be used.
##VOLUME_START_DT##	Optional placeholder. Placeholder will be replaced by the date of the oldest Recording archived on each volume.
##VOLUME_END_DT##	Optional placeholder. Placeholder will be replaced by the date of the newest Recording archived on each volume.
##XLATE_MATRIX##	Optional delimiter. Used to set a translation matrix that will be used to replace each string found with its placeholder. This translation matrix is a list of translation units. A string, which can be 1 character, is replaced by another string, which can be of a different length, or null. The translation units can be in the form of: <ul style="list-style-type: none"> • "abc"="ABC" replaces DataWithabcEmbedded with DataWithABCEmbedded • 'abc'="ABC" to have the possibility to replace the single or double apostrophe • abc="ABC" is also possible, but no '=' character can be replaced here. • 0x61bc="ABC" is also possible, and notice that these formats can be at the right of the equal sign, for example, abc=0x41BC • abc=ABC,def=DEF shows that you can have more than one definition between a single pair of delimiters

Volume Content Log File

The Volume Content log file uses the same template guidelines as the Volume Content Index log file. The Volume Content log file has additional placeholders, allowing the list to contain most of the attributes related to each recording.

Required localizable terms are part of the Volume Content resource template file. The following is an example of the **Volume Content resource template**.

```

<!DOCTYPE HTML PUBLIC "-//W3C//DTD HTML 4.01 Transitional//EN"
"http://www.w3.org/TR/html4/loose.dtd">
<html>

<head>
<META http-equiv="Content-Type" content="text/html; charset=utf-8">
<title>Archive volume content</title>

<style type="text/css">
.footer {
font-family: verdana, 'Lucida Grande', arial, sans-serif;
font-size: 10px;
color: #333333;
line-height: 1.3;
text-decoration: none;
margin-bottom: 10px;
}
th { text-align: left; font-weight: bold}
</style>
</head>
##FILE_NAME_PATTERN##Archive\Content*.html##FILE_NAME_PATTERN##
##XFER_FILE##logo.gif##XFER_FILE##
##CAPTION_CALL##Call##CAPTION_CALL##
##CAPTION_FAX##Fax##CAPTION_FAX##
##CAPTION_CHAT##Chat##CAPTION_CHAT##
##CAPTION_CHATTRANSCRIPT##Chat Transcript##CAPTION_CHATTRANSCRIPT##
##CAPTION_EMAIL##Email##CAPTION_EMAIL##
##CAPTION_SCREEN##Screen##CAPTION_SCREEN##
##CAPTION_INBOUND##Inbound##CAPTION_INBOUND##
##CAPTION_OUTBOUND##Outbound##CAPTION_OUTBOUND##
##CAPTION_INTERCOM##Inter com##CAPTION_INTERCOM##
##CAPTION_UNKNOWN##Unknown##CAPTION_UNKNOWN##
##CALLER_PHONE_PATTERN##CALLER##<##PHONE##>##CALLER_PHONE_PATTERN##
##CAPTION_RECORDING_TYPE_POLICY_RELATED##Policy-based##CAPTION_RECORDING_TYPE_POLICY_RELATED##
##CAPTION_RECORDING_TYPE_SNIPPET_RECORDING##Snippet
Recording##CAPTION_RECORDING_TYPE_SNIPPET_RECORDING##
<body>

<p>

</p>

<p>
Archiving volume content:
</p>

<p>
<table border=1>
<tr>
<th>#</th>
<th>Recording ID</th>
<th>Media Type</th>
<th>Recording Type</th>
<th>File Path</th>
<th>Recording Date</th>
<th>File size (bytes)</th>
<th>Direction</th>
<th>First participant</th>
<th>Other participants</th>
<th>Tags</th>
<th>Attributes</th>
</tr>
##FILE_LIST##FIRST_START_HERE##
<tr>
<td>##SEQUENCE_NUMBER##</td>
<td>##RECORDING_ID##</td>
<td>##MEDIA_TYPE##</td>
<td>##RECORDING_TYPE##</td>
<td><a href=##FILE_PATH##>##FILE_PATH##</td>
<td>##RECORDING_DATE##</td>
<td>##FILE_SIZE##</td>
<td>##DIRECTION##</td>
<td>##FIRST_PARTICIPANT##</td>
<td>##OTHER_PARTICIPANTS##</td>
<td>##TAGS##</td>
<td>##ATTRIBUTES##</td>
</tr>
##FILE_LIST##
</table>
</p>

<p>This volume content was automatically generated by Recorder Archiving.</p>

<p><span style='font-size:9.0pt;font-family:"calibri","sans-serif";"Times New Roman";color:#1F497D'>
<br>
</span></p>

<br><br>

<div align="center" class="footer">
&copy; Genesys
</div>

</body>
</html>

```

Most of the delimiters and placeholders defined in the previously displayed Volume Content Index resource template example are also used in the above Volume Content resource template.

The following table includes additional delimiters and placeholders used in the Volume Content resource template.

Delimiter or Placeholder	Description
##FILE_NAME_PATTERN##	A required parameter to get the pattern for the series of volume content log files. The required '*' will be replaced by the volume prefix followed by the volume number.
##MAX_RECORDINGS_PER_LOG##	An optional delimiter value to limit the number of recordings per Volume Content log file.
##DEFINE_ATTRIBUTE##	An optional delimiter Custom Attribute name. For example, '## <custom attribute name>##' will be available to store that Custom Attribute value.
##CAPTION_CALL##	An optional delimiter to get the localized "Call" term
##CAPTION_FAX##	An optional delimiter to get the localized "Fax" term
##CAPTION_CHAT##	An optional delimiter to get the localized "Chat" term
##CAPTION_CHATTRANSCRIPT##	An optional delimiter to get the localized "Chat Transcript" term
##CAPTION_EMAIL##	An optional delimiter to get the localized "EMail" term
##CAPTION_SCREEN##	An optional delimiter to get the localized "Screen" term
##CAPTION_INBOUND##	An optional delimiter to get the localized "Inbound" term
##CAPTION_OUTBOUND##	An optional delimiter to get the localized "Outbound" term
##CAPTION_INTERCOM##	An optional delimiter to get the localized "Intercom" term
##CAPTION_UNKNOWN##	An optional delimiter to get the localized "Unknown" term
##CALLER_PHONE_PATTERN##	An optional delimiter to get the localized "Caller[Phone]" edit pattern. If not present, the pattern will be "##CALLER##[##PHONE##]"
##CAPTION_RECORDING_TYPE_POLICY_RELATED##	An optional delimiter to get the localized "Policy-based" term
##CAPTION_RECORDING_TYPE_SNIPPET_RECORDING##	An optional delimiter to get the localized "Snippet Recording" term
##RECORDING_ID##	An optional placeholder that will be replaced by the Recording ID
##MEDIA_TYPE##	An optional placeholder that will be replaced by the localizedMedia Type
##RECORDING_TYPE##	An optional placeholder that will be replaced by the localized Recording Type
##TRANSACTION_ID##	An optional placeholder that will be replaced by the TransactionID
##ARCHIVE_PATH##	An optional placeholder that will be replaced by the archive path, terminated by a '\', suitable to concatenate with ##FILE_PATH## to get a full absolute file path.
##FILE_PATH##	An optional placeholder that will be replaced by the recordingfile path, relative to the Archive folder. Note that this will be replaced by the ##FILE_PATH_FOR_VOLUME## when this template is used for Volume Content in Volume folder.
##FILE_PATH_FOR_VOLUME##	An optional placeholder that will be replaced by the recording file path, relative to the Volume folder

##RECORDING_DATE##	An optional placeholder that will be replaced by the recording date in a standard format (not localized)
##RECORDING_DATE_UTC##	An optional placeholder that will be replaced by the UTC recording date in the format '2013-03-13T00:04:40.000-04:00
##RECORDING_DATE_OFFSET##	An optional placeholder that will be replaced by the signed date offset in minutes.
##DURATION_MS##	An optional placeholder that will be replaced by the duration of the recording in milliseconds.
##DURATION##	An optional placeholder that will be replaced by the duration of the recording in seconds.
##TO_CONNECTION##	An optional placeholder that will be replaced by the Interaction Address
##FROM_CONNECTION##	An optional placeholder that will be replaced by the Initiator Interaction Address
##ANI##	An optional placeholder that will be replaced by the ANI Deprecated Note This delimiter has been deprecated and is no longer supported. Use the ToConnection delimiter.
##ANI_PLAIN##	An optional placeholder that will be replaced by the ANI, with the '/' or '+' prefix removed. Deprecated Note This delimiter has been deprecated and is no longer supported. Use the ToConnection delimiter.
##DNIS##	An optional placeholder that will be replaced by the DNIS. Deprecated Note This delimiter has been deprecated and is no longer supported. Use the FromConnection delimiter.
##DNIS_PLAIN##	An optional placeholder will be replaced by the DNIS, with the '/' or '+' prefix removed. Deprecated Note This delimiter has been deprecated and is no longer supported. Use the FromConnection delimiter.
##FILE_SIZE##	An optional placeholder that will be replaced by the file size in bytes
##DIRECTION##	An optional placeholder that will be replaced by the localized direction
##LOCAL_PARTICIPANT##	An optional placeholder that will be replaced by the first local participant.
##LOCAL_GROUP##	An optional placeholder that will be replaced by the local workgroup if it was involved with the call.
##FIRST_PARTICIPANT##	An optional placeholder that will be replaced by the first (in time) participant
##OTHER_PARTICIPANTS##	An optional placeholder that will be replaced by the other participants (in time order), coma separated
##TAGS##	An optional placeholder that will be replaced by the coma separated list of tags

##ATTRIBUTES##	An optional placeholder that will be replaced by the coma separated list of custom attributes with their value
##CALLER##	An optional placeholder that will be replaced by the caller name
##PHONE##	An optional placeholder that will be replaced by the phone number
##SOCIAL_PLATFORM##	An optional placeholder that will be replaced by the platform for social recordings
##SOCIAL_CHANNEL##	An optional placeholder that will be replaced by the channel name for social recordings
##SOCIAL_CHANNEL_ID##	An optional placeholder that will be replaced by the channel id for social recordings
##SOCIAL_PAGE##	An optional placeholder that will be replaced by the page for social recordings
##CAPTION_ESCAPE_CHARACTERS##	An optional placeholder that will allow user defined escape sequence, which will be used to escape special characters, comma (,) and equal sign (=), in custom attribute name and value. By default, this placeholder sill be a backslash (\).

Appendix F: Identify Recordings by Spotted Keywords and Phrases for Evaluation

You can identify recordings for evaluation based on Spotted Keywords and Phrases. Creating an Initiation Policy to flag recordings that contain certain keywords and phrases allows you to use a Retention Policy to automatically assign a Questionnaire for evaluation.

Follow these steps to identify recordings, based on keywords and phrases for evaluation.

1. Create a Keyword Set in Interaction Administrator. Under **Interaction Analyzer**, click **Keyword Sets**. In the right-pane, click the new button to create a **New Item**, and specify **Name** and **Category**. Add keywords to the Keyword Set.
2. Create an Initiation Policy action to analyze recordings. In Interaction Administrator, under **Interaction Recorder**, select **Policy Editor**. In the right-pane, double-click **Configuration**. Create an Initiation Policy and apply the Action **listen for keywords spoken by agent** or **listen for keywords spoken by customer** to the interaction. Configure the variable to reference the Keyword Set created in Step 1.
3. Create a Retention Policy to automatically assign a Questionnaire to the recording, for evaluation.
 - a. In Policy Editor create a Retention Policy and apply the criteria **tag matches the following**. Configure the variable to match the Category specified in Step 1. To do this, in the **Tags Editor** dialog, add the Category in the **Enter a tag** field.
 - b. For this Retention Policy, apply the Action **assign questionnaire to** and configure the variable to select the Questionnaire to assign to the recording when a keyword from the Keyword Set is spotted.

Appendix G: Setup Automatic Login with SSO in Screen Recorder

This section describes how to automatically log in to Screen Recorder using Single Sign On (SSO) credentials.

Setting up SsoConfig.xml

1. Navigate to the client machine where you want screen recorder to automatically log in.
2. Create a folder in the PureConnect folder in AppData\Roaming named ScreenCaptureClientU.
3. Create another folder in ScreenCaptureClientU named Profiles.
 - a. The full path should now be: C:\Users\[USER PROFILE]\AppData\Roaming\PureConnect\ScreenCaptureClientU\Profiles
4. Create a file named SsoConfig.xml
5. Open SsoConfig.xml in a text editor.
 - a. The SsoConfig.xml needs 3 lines in order to log in using SSO credentials:
 - i. username=[DOMAIN\USER]
 - i. example: username=QFUN\waldronadmin
 - ii. password=[PASSWORD]
 - i. example: password=testing
 - iii. sso_identity_provider=[SSO_IDENTITYPROVIDER_GUID]
 - i. example: sso_identity_provider=f1aa12b3-dba2-4cab-b909-2c2b7afcf1fd
 - a. The SSO identity provider GUID can be found in the DS Server logs
6. Save SsoConfig.xml
 - a. The final xml file should look something like this:

```
SsoConfig.xml
username=QFUN\waldronadmin
password=testing
sso_identity_provider=f1aa12b3-dba2-4cab-b909-2c2b7afcf1fd
```

Setting up config.xml

1. Navigate to C:\Program Files (x86)\PureConnect\ICUserApps
2. Edit or create the file config.xml
3. Enter the following lines into the config.xml file and change [ICSERVER] to the correct IC Server address.
config.xml example:

```
<sreconfig>
<controlserver>
<parameter name="server" value="[ICSERVER]"/>
</controlserver>
</sreconfig>
```

4. Save the file.
5. To log in using these credentials, kill and restart screenrecorderclient or restart the machine.

Appendix H: Snippet Recordings of Email Interactions

Email Snippet recordings are available as a feature toggle with a server parameter setting. It is important to be aware that an email snippet is the full email, not just a portion of the email. For this reason it is of most value only to customers who choose not to make policy-based recordings of emails or to those who are not recording 100% of email interactions. Partial email recording is not supported due to the fact that the behavior of a recorded email interaction is different than that of call and chat snippets.

Snippet Recordings of email interactions in Interaction Desktop and Interaction Connect are available only if your CIC administrator separately enables this feature. Snippet Recordings of email interactions are not available by default.

Enable Email Snippet Recordings

To create email Snippet Recordings, a server parameter must be added to the CIC server, in Interaction Administrator. To create the new server parameter, follow these steps.

1. In Interaction Administrator, select the **Server Parameters** container.
2. In the workspace, right-click and select **New**.
3. In the Entry Name dialog, enter **Enable Email Snippet Recordings**, and click **OK**.
4. In the Parameter Configuration New Parameter dialog, on the **Configuration** tab, enter a value in the **Parameter Value** field. Acceptable values are: **yes**, **true** (both case insensitive), or **1**. Click **OK**.

This new server parameter does not require any subsystem to be restarted.

When the **Enable Email Snippet Recordings** server parameter is enabled, users who are properly configured for Snippet Recordings will see the Snip capability available in their Email interactions.

Creating an Email Snippet Recording

You can start an Email Snippet recording at any time, in the original email or in the reply or forward email. Use the **Snip** button to start and stop email recordings. All of the text in the original email interaction and the reply is included in the Email Snippet recording.

For information on adding the **Snip** button to Email windows, see the Interaction Desktop (client) Help.

For additional information on creating Snippet recordings, see [Create a Snippet Recording](#).

Considerations for Email Snippet Recordings

- Email Snippet Recordings can be started at any time for an email interaction. This includes starting in the original email message or starting in the reply or forwarded email. The Snippet recording needs to be active for the duration of the reply or forwarded message. Also, the Snippet recording of the original (parent) interaction needs to be active until the parent interaction is disconnected or transferred.
- When replying or forwarding to a parent email interaction that has a Snippet recording in progress, the snippet needs to continue recording until the parent interaction is disconnected or the snippet recording will not be created.
- If you start a Snippet recording in an email reply or forwarded email, and the Snippet recording is stopped or disconnected before the reply is sent or the email is forwarded, the Snippet recording is *not* saved.
- If you start a Snippet recording on an unsent email reply, a Snippet recording is not created until the email reply is sent.
- All of the text in the original email interaction or the email reply is included in a Snippet recording. Partial recordings are not supported.
- All of the requirements listed in [Requirements for Snippet Recordings](#) apply to Snippet recordings of email interactions.

Appendix I: Interaction Screen Recorder Capture Client config.xml file

When the Interaction Screen Recorder Capture Client is installed, the configuration options are included in the config.xml file. The config.xml file is located at C:\Program Files (x86)\PureConnect\ICUserApps (directory of IC User Apps installation).

When using the command-line option to install the Interaction Screen Recorder Capture Client, after the install is complete, edit the config.xml file to update your configuration options.

Here is an example of the Interaction Screen Recorder Capture Client config.xml file that has been updated.

```
<sreconfig>
  <controlserver>
    <!--No value defaults to https://{host}:8019 and enables the web connection. -->
    <!--"{host}" is replaced with servers in alternate host list provided by SM -->
    <parameter name="http_connection"/>

    <!--Supports URL as a value to the HTTP Plugin Host where you can specify HTTP or HTTPS.-->
    <parameter name="http_connection" value="http://{host}:8018"/>

    <!--Supports host substitution anywhere in the path. Useful for reverse proxies.-->
    <parameter name="http_connection" value="https://reverse_proxy_1.com/ic/{host}"/>

    <!--Primary server-->
    <parameter name="server" value="server1"/>

    <!--Backup server needed for retrieving alternate hosts after a switch.-->
    <parameter name="alt_server" value="server2"/>

    <!--Specify servers.json filename to retrieve list of IC server host names -->
    <parameter name="hostservers_URL" value="https://apps.caas.com/customerA/crm/config/myservers.json"/>

    <!--No filename specified, capture client will append /servers.json-->
    <parameter name="hostservers_URL" value="https://apps.caas.com/customerA/crm/config"/>

    <!--IC User to log into IR Server.-->
    <parameter name="ic_user" value="admin"/>
  </controlserver>
</sreconfig>
```

Appendix J: Interaction Recorder Event IDs

The following table lists Interaction Recorder Event IDs that are found in the Application Event log.

Event ID	Message
10000	The Notifier connection to subsystem XX:IRContentSvc_%RCS%_%ICSERVER%_XXXX(%RCS%, XXX.XXX.XXX.XXX:PORT#) has ended. NOTE: This is a heavily shared port number in relation to Notifier events in the Windows Event Log. Care will need to be had when implementing this EventID to ensure that the text of the error is considered when creating alerts on this EventID.
23032	Unable to make a recording for user XXXX at workstation XXXX because the user/workstation is unlicensed.
23044	Recorder Server has started reapplying the Retention policies for all recordings. OR Recorder Server has started reapplying the Security policies for all recordings.
23045	Recorder Server has started reapplying the Retention policies for recordings created between specific dates. OR Recorder Server has started reapplying the Security policies for recordings created between specific dates.
23046	Recorder Server has completed reapplying the Retention policies. OR Recorder Server has completed reapplying the Security policies.
23047	Recorder Server reapply of the Retention policies was cancelled. Number of Recordings processed = [X] of an expected [Y]. Please see the Recorder Server.ininlog for more details. OR Recorder Server reapply of the Security policies was cancelled. Number of Recordings processed = [X] of an expected [Y]. Please see the Recorder Server.ininlog for more details.

Appendix K: SIP Proxy Recording Recovery

Use the SIP Proxy Recording Recovery Utility to import the recording files into PureConnect and save them to the recording database.

Note: The recording files that are generated by SIP server have .wav format and the metadata that is generated by SIP server have .csv format. Only files with these formats are supported.

Information Required (Prerequisites)

Before using the tool, administrators need to know the below information.

Public Recorder Key

Interaction Recorder uses a unique public key to encrypt the recording files. The SIP Proxy Recording Recovery Utility reads the public key from the registry given path `HKEY_LOCAL_MACHINE\SOFTWARE\Wow6432Node\Interactive Intelligence\EIC\Directory Services\Root\Production\Interaction Recorder\Recordings Public Key`. Make sure to set this registry key.

Retention Location

By default, the SIP recordings are saved in the existing policy location. All the recordings processed by the utility will have `SIPRecording` tag assigned. In case if you wish to create a new retention policy to save all the SIP recordings in a separate location by using the `SIPRecording` tag as a criteria.

Policy description (click an underlined value to edit):
If the interaction meets the following criteria: tag matches the following SIPRecording

Make sure that the destination location mentioned in the policy has enough free space to accommodate the recordings. The utility must also have read and write access permission to the path.

Important: Check if the `Recording Path` server parameter is set or not. If not, then set the parameter before running the utility in the Interaction Administrator.

InitialMirrorDir	
Interaction Limit (Chats)	4000
Internal Call Classifications	Intercom,Internal
MaxSimultaneousI3STSConnections...	5
MirrorExceptions	*.ivp
NewVMPollingInterval	240
OutOfBandReportDataTransfer	0
Play Queue Announcements	External
ProcessIVREvents	True
Reco Call Type	Both
Recording Path	D:\I3\IC\Recordings\
RecordServer	
ReportComponentsInstalled	REPORTS;PMQLOGGING
ReportFilePath	\\\${SERVERNAME}\IC_Reports\SQL
Resource Path	D:\I3\IC\Resources
Rx Document Path	D:\I3\IC\Server\I3RxDocs

Processed Files Location:

After a .wav file recording is processed, it will be moved to the processed file location so that it is passed as an input to the utility. It is been done to avoid an issue of reprocessing recordings that has been already processed successfully. It will prevent the duplicate recordings moving into the database. All the unprocessed files will remain in the same location and will not be moved.

Processed file location can also be a network, or a shared path provided with appropriate read and write permissions.

Playback from ICBM Client

You can search for the interaction recording files either by using the tag **SIPRecording** or **Initiated Date** from the ICBM.

Configure Recording Search

Title: Maximum results:

Location: Author: boreas_user

New Attribute ▾ ⬇ ⬆ ✖

Recording Tag

Equal to ▾ ▾

Date/Time

Specify a date/time range Specify a date period Specify shift date/time period

Before ▾ at

Using the Tool

It is recommended to run the tool from the IC server with read and write access for both the original and processed files location. The utility converts .wav recording files to .sasf recording files and it encrypts if required, it produces a log file in format **SipRecordingProcessor_YYYY_MM_DD_HHMMSS.log**. Utility can be used to process single or entire directory of recordings using the utility commands.

Note: For all the directory or file paths, you must have read and write permissions.

Utility commands:

Single file:

```
siprecordingprocessorU <wav file to convert> <csv file> <encryption required: true/false> <processed wav files directory>
```

Multiple files:

```
siprecordingprocessorU <wav files directory> <csv files directory> <encryption required: true/false> <processed wav files directory>
```

Examples:

Single file:

```
siprecordingprocessorU.exe D:\testing\sampleRecordings\final.wav D:\testing\samplemetadata\11-09-2021.csv false D:\processed
```

Multiple files:

```
siprecordingprocessorU.exe D:\testing\sampleRecordings D:\testing\samplemetadata true D:\processed
```

Network path:

```
siprecordingprocessorU.exe \\boreas\sampleRecordings\final.wav \\boreas\samplemetadata\11-09-2021.csv false D:\processed
```

```
siprecordingprocessorU.exe \\boreas\sampleRecordings \\boreas\samplemetadata true D:\processed
```

Utility Output

After the execution of the utility, all the successfully processed files will be moved to the Recording Path on the IC Server and will be waiting to be picked up by the Rescue Job.

Note: You need to wait for about an hour for the process to finish.

Rescue job picks up the .sasf files and moves them to retention location, it also moves the record to the database.

Log File

A log file will be generated at the location of utility exe in the format of **SipRecordingProcessor_YYYY_MM_DD_HHMMSS.log**

This log file will contain detailed information about the individual files that have been processed, errors encountered, and so on.

Note: The files that are converted successfully without any issues are moved to the Processed Files Location. So that while you re-run the utility, already processed recordings will not be re-processed.

Change Log

The following table summarizes the updates made to the *Interaction Recorder Technical Reference*.

Date	Changes
13-January-2015	<ul style="list-style-type: none"> Updated playback a screen recording for keeping audio and video in sync Updated Copyright and Trademarks for 2015 Add information for questionnaires marked for calibration in search results
19-January-2015	<ul style="list-style-type: none"> Noted all Amazon S3 communication uses HTTPS protocol Updated Retention Criteria descriptions, Store Media at and Archive Recording to, for viewing a screen recording
16-March-2015	Added Interaction Quality Manger to title
31-March-2015	Updated "Lag Time"
06-April-2015	Updated for "Event Hold" times
07-April-2015	Updated for new Type column for Events datagrid
08-April-201	<ul style="list-style-type: none"> Replaced <i>Interaction Client</i> with <i>Interaction Desktop</i> for Secure Pause related to Screen Capture. Updated "Manage Interaction Recorder Settings" for UI change for Handset Updated for UI change for Scorecard Search Attribute Signature Status
09-April-201	Additional updates for "Number of Holds", "Hold Time", and "Total Hold Time" search attributes
22-April-2015	Updated configuring question settings
26-May-2015	Added section on Policy Editor toolbar buttons
22-June-2015	<ul style="list-style-type: none"> Updated screen capture for Recordings to Score attributes dialog for Scoring User field Updated title page for new rebranding Updated Keyword scores tab to Keywords tab
07-July-2015	Added new information for Interaction Analyzer recording search attributes
08-July-2015	<ul style="list-style-type: none"> Added information for copying recording details and scorecard details from datagrid to clipboard Added information for exporting recording search results, including exporting Results Rows to a file
09-July-2015	Added information to Delete a Scorecard from search results shortcut menu
13-July-2015	Removed reference to Historical Reports in IC Business Manager Help
14-July-2015	Updated Abstract on title page for Interaction Quality Manager
02-September-2015	<ul style="list-style-type: none"> Updated documented for removing hyperlink to create a questionnaire from assigning a questionnaire dialog Updated "Score Recording" for changes in Comment form
03-September-2015	<ul style="list-style-type: none"> Added information on new Calibration button in Media Details pane Updated graphics for UI changes
04-September-2015	Added information for Details pane Keywords page
11-September-2015	Added information on silent login for "Capture Client"
14-September-2015	Updated sample report for "Run a Quality Scorecard Report"
28-September-2015	Updated graphics for Calibration button
29-September-2015	<ul style="list-style-type: none"> Updated installation screens for Interaction Screen Recorder Capture Client Updated installation screens for Interaction Recorder Client Added new information to assign calibration scorecards

01-October-2015	<ul style="list-style-type: none"> Added new Recording Search Attribute information for Total Keyword Score. Updated information for Spotted Confidence displayed values
02-October-2015	Updated Role limit for Retention policy
05-October-2015	Update to definition of Critical question
30-November-2015	UI text formatting change for Policy criteria Recording has been archived
08-December-2015	Added SSO log in credentials to "Appendix G"
10-December-2015	Updated screen capture for UI update in "Edit Security Policy"
14-December-2015	Updated user/station information for encumbered recordings
18-January-2016	Updated for new configuration option for Amazon S3 cloud services using HTTP or HTTPS
24-January-2016	Updated Copyright and Trademark Information
02-March-2016	Minor update to chart for Snippet Recording Type
03-March-2016	<ul style="list-style-type: none"> Updates for "Interaction Recorder Snippet Recording" for: Security Policies, Retention Policies, Search attributes, and Recorder Data Grid Updated "Appendix D: Archive Recordings" for new Recording Type column Updated "Appendix E: Archive log Resource Templates" with new Resource Template placeholders for new Recording type
11-March-2016	Added new section for "Interaction Recorder Snippet Recordings"
16-March-2016	Added Appendix for Administrator for new media type for Snippet Recordings
21-March-2016	Updated screen captures for Snippet Recordings
30-March-2016	Updated Appendix for Snippet Recordings
05-April-2016	Additional updates for "Appendix H"
07-April-2016	Added additional information for email Snippet Recordings
12-May-2016	Updated "Initiation Policy Criteria Descriptions" for random selection of calls to interactions
19-May-2016	Added new information for "Initiation Policy Overview"
23-May-2016	Added new information for Recorder Policy Editor Archive Action for storage size error and warning
26-May-2016	Added new information for Amazon S3 region endpoint
12-July-2016	Added information for Recorder Health Check
12-September-2016	Added information for Enable HTTPS Exchanges
31-October-2016	Added new compression formats, for Opus Mono and Dual-channel, when configuring Interaction Recorder Configuration dialog
03-November-2016	<ul style="list-style-type: none"> Updated for Media Information message boxes for Dual-channel Opus and Mono Opus recordings Added information for exporting Opus compression format recordings Updated "Email a Recording" for Opus file name extension
08-November-2016	<ul style="list-style-type: none"> Added new information for Opus (Dual-channel) recordings when playing back a call Added new information for compression factors for Opus Included information on Opus recordings not being supported on Interaction Media Servers before 2017 R1.
10-November-2016	Updated disk space requirements and Media Servers for Opus recordings
06-January-2017	Updated "Cloud Services Configuration" for Amazon S3

14-February-2017	Added information for AWS S3 bucket user permissions
16-February-2017	Added information for recording playback speed control
17-February-2017	Updated for new Bookmark information in the Audit Trail
27-February-2017	Added information regarding Opus recordings and Remote Content Server (RCS) versions
21-April-2017	Updated Doc Library URL
16-June-2017	Added information for Park, Hold Type, when configuring a Search attribute and working with Search results.
07-July-2017	Updated information for Screen Recording lag time
03-August-2017	Park search attribute update
04-August-2017	Update to Playback timeline for Park events
07-August-2017	Updates for custom attribute value for special characters
08-August-2017	Update for Archive Report Template for caption escape character
10-August-2017	Deprecated Archive Report Template delimiters ANI, ANI_PLAIN, DNIS, and DNIS_PLAIN
18-August-2017	<ul style="list-style-type: none"> • Updated Archive recording email example • Updated "Archive Log Resource Templates" and sample for List of Archived Recordings • Updated IC Business Manager Applications setup • Updated IC User Applications (64-bit) setup
25-August-2017	<ul style="list-style-type: none"> • Updated graphics for the Archiving Volume Content Index • Updated graphic for Quality Scorecard report
05-September-2017	Additional updates for 2018 R1 rebranding
25-October-2017	Added information for additional operating system requirements for exporting screen recordings
16-November-2017	<ul style="list-style-type: none"> • Updates for HTTP connection for Screen Recorder Capture Client installation, for 2018 R2 and later • New information for "IC User Applications (64-bit) Setup Wizard" command-line installation
17-November-2017	Added "Appendix I: Interaction Screen Recorder Capture Client" config.xml file
15-December-2017	Updated graphic to remove Related Recording from Participant Data tab in Detail pane
19-December-2017	New feature to specify a custom Amazon S3 region and endpoint for Policy Editor Retention Policy
31-January-2018	Edits for document format conversion
27-March-2018	Updated placeholders for Volume Content Log File resource template
24-April-2018	Update for exporting a screen recording and Windows 2016 for The Desktop Experience
02-May-2018	Updated "Appendix C" server parameters for Disable Expired Recordings Processing
03-May-2018	Corrected wording for Screen Recorder Session license for one user with multiple screens
10-July-2018	Updated Retention Policy Description
11-July-2018	Updates for Social Media conversations for Initiation Policy
14-July-2018	Updates for Social Media conversations for Retention Policy
14-July-2018	Updates for Social Media conversations for Security Policy
16-July-2018	Update for Enable HTTPS exchanges for S3 Bucket name
21-July-2018	Added new information for Social Media Conversations

24-July-2018	Updated exporting for Social Media recordings to Zip file format
26-July-2018	Updates for Archiving for Social Media
27-July-2018	Added additional information for Social Media recordings to Zip file format
01-August-2018	Added Appendix J: Interaction Recorder Event IDs
01-August-2018	Updated delimiters and placeholders in the Volume Content Resource template for Social Media
09-August-2018	Updated graphic for Hold event indicator
04-September-2018	Updated Initiation Policy for Social Direct Message
04-September-2018	Updated Retention Policy for Social Direct Message
05-September-2018	Updated Security Policy for Social Direct Message
06-September-2018	Updated recording Search Attributes for Social Direct Message
07-September-2018	Updates for UI changes for search attribute Media Specific > Social Conversation for attributes: Social Conversation Platform, Social Conversation Channel, and Social Conversation Page
09-September-2018	Added new information for Social Direct Message
02-October-2018	Updated internal links for Cloud Services Configuration
12-October-2018	Updated KB article link for: Modify properties for the ININ QoS driver installation
19-December-2018	Updates for recording retention based on Recording Date, including updates for: Policy Editor Retention Policies, Security Policies; Appendix C: Server Parameters; Media Details pane.
20-December-2018	Updated Interaction Recorder Client Search Results Grid for new Expiration Date column, and for modifying recording Expiration Date in search results.
02-January-2019	Updated Media Details pane information for including Expiration Date field.
04-January-2019	Added new section, Modify Retention Expiration, for modifying the retention expiration period to set the date and time for a recording to be re-evaluated.
07-January-2019	Added information for optional server parameter for IR Use Recording Date For Expired Calculations to Appendix C.
09-January-2019	Updated screen captures for Expiration Date field in the Media Details pane.
29-January-2019	Added error confirmation information for Social Media Initiation policy discrepancies between criterion and events.
29-January-2019	Updated for Send as Email size restriction notification message error
03-April-2019	Updates for WAV form not displayed when using handset for playback.
04-April-2019	Update for Audio Playback Devices.
04-April-2019	New graphic for Audio menu in Playback dialog.
03-May-2019	Added information on importing policies.
06-June-2019	Fixed broken links.
25-July-2019	Updated audio playback devices.
15-October-2019	Updated Appendix D: Archive Recordings- removed reference to screen recordings and added link to KB article Archiving in Interaction Recorder.
30-October-2019	Added licensing requirements for viewing and modifying tags/attributes using IceLib.

14-February-2020	Updated description of Secure Recording Pause Duration (seconds) in the Interaction Recorder Configuration topic.
03-March-2020	Updated requirements to include Windows Server 2019.
30-April-2020	Updated links from my.inin.com to new locations.
03-June-2020	<p>Most, if not all, customers have already migrated from CIC 2.4/3.0 to a later release. Therefore, changed the following:</p> <ul style="list-style-type: none"> • Removed "Migrating from a previous release." • Renamed "Appendix B: CIC 2.4/3.0 to 2015 R1 or Later Migration" to "Appendix B: Search Configuration Migration Notes Control."
12-June-2020	Updated Appendix I to include location of config.xml file.
08-July-2020	Updated Email a recording topic to link to Interaction Recorder configuration topic for Reply To email address configuration.
27th-January-2022	Added SIP Proxy Recording Recovery Utility information in Appendix K